

DORMER

样本
Catálogo
Catalogue

2015



A		B170	156	C835	447	E260	226	EP006G	210	H		S	
A002	60	B180	154	C837	446	E261	226	EP006H	210	H853	16	S216	372
A002S	60	B301	149	C903	419	E263	221	EP00TIN	210	H855	19	S217	374
A022	46	B334	146	C907	418	E266	219	EP016H	210	H858	22	S218	375
A088	119	B335	147	C908	431	E268	237	EP10	243	H861	16-24	S219	369
A094	123	B400	138	C920	419	E275	254	EP10TIN	243	H862	16-24	S225	378
A095	120	B411	142	C921	433	E278	263	EP11	243	K		S226	379
A099	121	B441	141	C922	428	E282	284	EP20	257	K100	471	S227	380
A100	64	B442	143	C944	432	E290	237	EP21	257	K101	471	S229	391
A101	64	B481	139	C948	432	E291	232	EP30	266	K102	471	S231	392
A108	64	B901	148	D		E292	232	EP31	266	K103	472	S233	393
A110	84	B903	150	D200	452	E293	232	EP40	286	K104	472	S260	376
A117	46	B952	151	D400	461	E294	232	EP41	286	K200	473	S262	387
A120	46	B953	153	D402	462	E295	233	EX006G	224	K201	473	S264	382
A122	45	B954	165	D420	461	E296	233	EX006H	224	K202	473	S501	397
A124	54	B955	166	D422	462	E297	212	EX00TIN	224	K203	473	S511	400
A125	90	B956	167	D745	454	E298	225	EX016H	224	K204	473	S521	384
A130	97	B957	168	D747	456	E299	245	EX10	248	K300	468	S523	385
A160	73	C		D750	460	E300	250	EX10TIN	248	K301	468	S524	383
A166	103	C110	404	D751	460	E303	208	EX11	248	K302	468	S525	378
A170	71	C122	416	D752	459	E382	289	EX20	259	K303	468	S526	379
A190	122	C123	406	D753	459	E383	251	EX21	259	K304	468	S527	380
A191	124	C126	404	D763	452	E384	246	EX30	268	K305	468	S529	394
A199	125	C135	408	E		E390	203	EX31	268	K310	469	S531	395
A200	115	C139	406	E000	216	E422	219	EX40	288	K311	469	S533	396
A201	117	C159	413	E000TIN	216	E423	219	EX41	288	K312	469	S534	398
A205	115	C166	424	E001	216	E471	215	F		K313	469	S535	399
A210	116	C167	415	E002	229	E472	215	F100	317	K314	469	S536	390
A225	118	C169	413	E002TIN	229	E473	228	F108	317	K330	470	S610	366
A243	83	C246	420	E003	229	E474	228	F110	319	K331	470	S611	367
A244	83	C247	420	E011	247	E500	204	F120	321	K332	470	S612	371
A295	126	C273	422	E013	252	E501	204	F130	322	K333	470	S629	401
A296	127	C295	422	E021	258	E504	204	F140	323	K334	470	S637	364
A345	106	C299	418	E023	260	E510	217	F150	324	K520	474	S638	365
A350	104	C305	412	E031	267	E513	239	F170	325	K521	475	S710	359
A400	110	C306	409	E033	269	E515	255	F180	326	K522	476	S714	362
A402	111	C324	427	E041	287	E524	264	F190	327	L		S715	363
A405	112	C333	425	E043	290	E531	273	F201	317	L110	302	S717	374
A412	113	C336	414	E052	223	E533	276	F202	333	L111	303	S718	375
A413	114	C346	417	E100	199	E534	275	F272	336	L113	306	S739	402
A510	74	C352	412	E101	199	E536	277	F300	328	L114	307	S740	402
A520	51	C353	409	E102	199	E538	279	F302	334	L115	308	S741	402
A530	97	C358	414	E105	234	E539	278	F310	329	L119	304	S761	376
A553	77	C359	425	E108	253	E542	280	F312	335	L120	309	S763	386
A554	77	C365	426	E111	262	E544	282	F320	330	L126	305	S765	381
A620	46	C367	411	E115	272	E545	281	F330	331	M		S766	377
A720	55	C400	434	E119	283	E547	285	F370	332	M138	182	S767	389
A730	97	C403	435	E200	201	E550	293	G		M150	477	S802HA	355
A777	64	C407	431	E201	203	E570	271	G125	184	M151	478	S802HB	355
A900	79	C413	434	E207	221	E600	209	G129	174	M152	479	S803HA	357
A901	79	C428	429	E212	221	E605	231	G132	179	M200	480	S803HB	357
A920	56	C429	435	E216	219	E606	218	G135	171	R		S804HA	368
A921	56	C492	430	E225	254	E610	209	G136	176	R100	35	S804HB	368
A940	87	C500	436	E229	263	E620	291	G137	172	R120	26	S812HA	356
A941	87	C503	436	E237	201	E621	292	G138	180	R122	25	S812HB	356
A951	108	C505	437	E238	227	E650	230	G142	176	R123	25	S813HA	358
A952	108	C511	438	E239	227	E651	261	G149	175	R453	39	S813HB	358
A976	94	C700	451	E240	214	E653	297	G154	173	R454	39	S814HA	370
A977	94	C710	450	E241	214	E654	270	G171	181	R457	31	S814HB	370
A978	94	C800	439	E242	237	E708	300	G236	185	R458	31	S902	360
B		C801	442	E243	301	E709	299	G314	183	R459	42	S903	361
B100	144	C810	440	E244	237	E710	295	G335	171	R510	37	S904	373
B101	162	C820	444	E243	301	E711	296	G338	180	R520	28	S922	360
B121	164	C822	443	E250	201	E712	298	G400	169	R950	13	S933	361
B122	152	C825	441	E251	201	E714	294	G405	170	R960	13	S944	373
B157	159	C830	448	E252	203	E720	299	G560	176	S		S991	403
B161	160	C831	449	E255	213	E721	295	G570	176				
				E256	213			G600	178				
				E258	221								

3 - 128



129 - 186



187 - 312



313 - 336



337 - 462



463 - 480

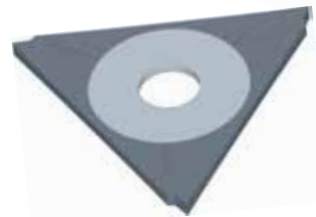

481 - 560

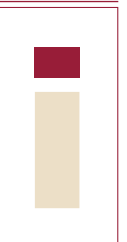

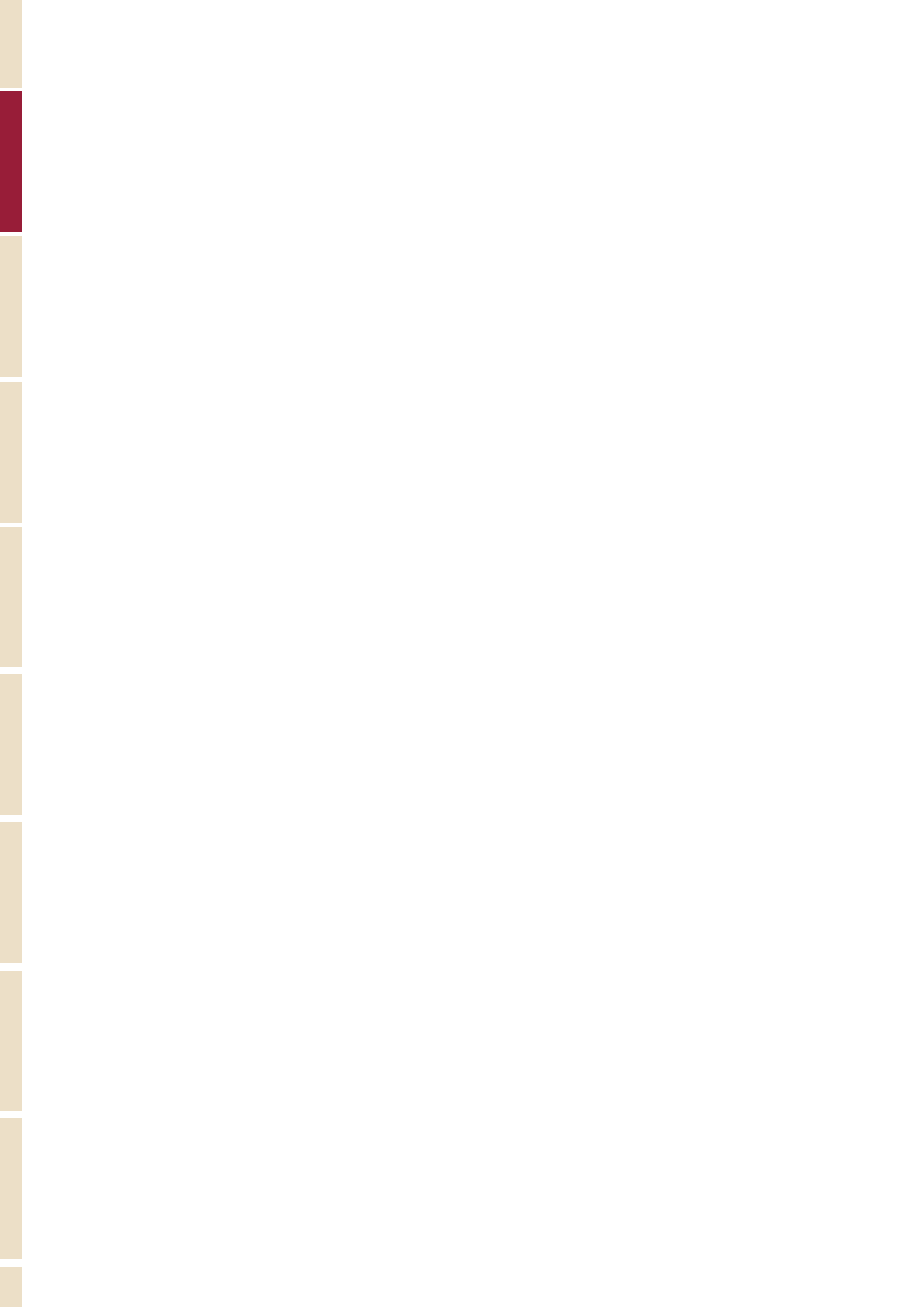

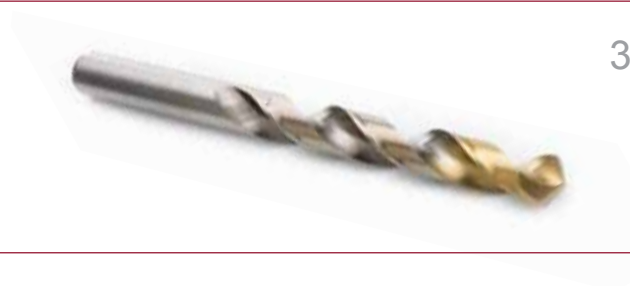

A002	60	A191	124	A553	77	R100	35
A002S	60	A199	125	A554	77	R120	26
A022	46	A200	115	A620	46	R122	25
A088	119	A201	117	A720	55	R123	25
A094	123	A205	115	A730	97	R453	39
A095	120	A210	116	A777	64	R454	39
A099	121	A225	118	A900	79	R457	31
A100	64	A243	83	A901	79	R458	31
A101	64	A244	83	A920	56	R459	42
A108	64	A295	126	A921	56	R510	37
A110	84	A296	127	A940	87	R520	28
A117	46	A345	106	A941	87	R950	13
A120	46	A350	104	A951	108	R960	13
A122	45	A400	110	A952	108		
A124	54	A402	111	A976	94		
A125	90	A405	112	A977	94		
A130	97	A412	113	A978	94		
A160	73	A413	114	H853	16		
A166	103	A510	74	H855	19		
A170	71	A520	51	H858	22		
A190	122	A530	97	H860	16-24		
				H858	16-24		

	中文	Português	Español	English
	钻头 钻头图标	Código Ícones de Brocas	Código de producto Iconos de taladrado	Drill head codes Drill head icons
	尺寸范围	Gama de medidas	Rango de Diámetros	Size Range
	天龙钻刀杆	Código	Código de producto	Drill body codes
■	性能卓越	Excelente para a Aplicação	Excelente para Aplicación	Excellent for Application
■	性能良好	Bom para a Aplicação	Bueno para Aplicación	Good for Application
	实例 10 = 外缘处的切削速度, 米/分, +/- 10%	Exemplo 10 = Velocidade periférica em metros/minuto +/- 10%	Ejemplo 10 = Velocidad Periférica en metros/minuto +/- 10%	Example 10 = Peripheral speed in metres/minute +/- 10%
	材料	Material	Material	Material
	标准	Norma	Estándar	Standard
	深度	Profundidade	Profundidad	Depth
	涂层	Tratamento	Tratamiento superficial	Coating
	柄部	Haste	Mango	Shank
	加工方向	Direção	Dirección	Direction
	冷却	Refrigeração	Refrigeración	Coolant
	尺寸范围	Gama de medidas	Rango de Diámetros	Size Range
AMG	中文	Português	Español	English
1.1	铁磁性低碳钢	Aço macio magnético	Acero blando	Magnetic soft steel
1.2	结构钢, 表面渗碳钢	Aço estrutural, Aço cementado	Acero de construcción/cementación	Structural steel, case carburizing steel
1.3	普通碳钢	Aço-carbono	Acero al carbono	Plain Carbon steel
1.4	合金钢	Aço de liga	Acero aleado	Alloy steel
1.5	合金钢, 淬火回火钢	Aço de liga, Aço temperado	Acero aleado/temple y revenido	Alloy steel, Hardened and tempered steel
1.6	合金钢, 淬火回火钢	Aço de liga, Aço temperado	Acero aleado/temple y revenido	Alloy steel, Hardened and tempered steel
1.7	热处理合金钢	Aço de liga temperado	Acero aleado cementado	Alloy steel, Heat treated
1.8	淬火合金钢, 耐磨钢	Aço de liga temperado	Acero aleado cementado	Alloy steel, Hardened & Wear resistant steel
2.1	易切削不锈钢	Aço inoxidável de maquinação fácil	Acero inoxidable fácil mecanizado	Free machining, Stainless Steel
2.2	奥氏体不锈钢	Austenítico	Acero inoxidable	Austenitic
2.3	铁素体 + 奥氏体, 马氏体不锈钢	Ferrítico + Austenítico + Martensítico	Ferrítico, Ferr. + Aust., Marten	Ferritic + Austenitic, Ferritic, Martensitic
2.4	沉淀硬化不锈钢	Aço inoxidável de fácil usinagem	Acero Inoxidable Templado	Precipitation Hardened
3.1	灰铸铁	Grafite laminar	Con grafito laminar	Lamellar graphite
3.2	灰铸铁	Grafite laminar	Con grafito laminar	Lamellar graphite
3.3	球墨铸铁, 可锻铸铁	Grafite nodular/ Ferro fundido maleável	Con graf. laminar, fundic. maleable	Nodular graphite, Malleable Cast Iron
3.4	球墨铸铁, 可锻铸铁	Grafite nodular/ Ferro fundido maleável	Con graf. laminar, fundic. maleable	Nodular graphite, Malleable Cast Iron
4.1	纯钛	Titânio, sem liga	Titanio no aleado	Titanium, unalloyed
4.2	钛合金	Titânio, com liga	Titanio aleado	Titanium, alloyed
4.3	钛合金	Titânio, com liga	Titanio aleado	Titanium, alloyed
5.1	纯镍	Níquel, sem liga	Níquel no aleado	Nickel, unalloyed
5.2	镍合金	Níquel, com liga	Níquel aleado	Nickel, alloyed
5.3	镍合金	Níquel, com liga	Níquel aleado	Nickel, alloyed
6.1	紫铜	Cobre	Cobre	Copper
6.2	β黄铜, 青铜	Latão beta, bronze	β-Latón, bronce	β-Brass, Bronze
6.3	α黄铜	Latão alfa	α-Latón	α-Brass
6.4	高强度青铜	Bronze de alta resistência	Metal AMPCO	High Strength Bronze
7.1	纯铝, 纯镁	Al, Mg, sem liga	Al, Mg, no aleado	Al, Mg, unalloyed
7.2	铝合金, 硅含量 < 0.5%	Al com liga, Si<0.5%	Al aleado con Si < 0.5%	Al alloyed, Si < 0.5%
7.3	铝合金, 硅含量 > 0.5% < 10%	Al com liga, Si>0.5%<10%	Al aleado con Si > 0.5% < 10%	Al alloyed, Si > 0.5% < 10%
7.4	铝合金, 硅含量 > 10% 晶须增强铝合金, 镁合金	Al com liga, Si>10% reforçadas com monocristais filiformes, ligas de Al/Mg	Al aleado, Si>10% Reforzado por filamentos, Al-aleados, Mg-aleados	Al alloyed, Si > 10% Whisker reinforced Al-alloys Mg-alloys
8.1	热塑性塑料	Termoplásticos	Termoplásticos	Thermoplastics
8.2	热固性塑料	Plásticos termoduros	Plásticos endurecidos por calor	Thermosetting plastics
8.3	增强塑料	Materiais plásticos reforçados	Materiales plásticos reforzados	Reinforced plastic materials
9.1	金属陶瓷	Cerametal (metalocerâmica)	Cerametales (metales-cerâmicas)	Cermets (metals-ceramics)
10.1	标准石墨	Grafite standard	Grafito standard	Graphite

R950			R960		
	HM				
15/32" - 42.00	15/32" - 42.00	13.50 - 30.50	15/32" - 30.50	15/32" - 30.50	13.50 - 30.50
H853	H855	H858	H853	H855	H858
HSS	HSS	HSS	HSS	HSS	HSS
3XD	5XD	8XD	3XD	5XD	8XD
DN 8535HB DN 8535HE	DN 8535HB DN 8535HE	DIN 8535HE	DN 8535HB DN 8535HE	DN 8535HB DN 8535HE	DIN 8535HE
12.00 - 42.50	12.00 - 42.50	14.00 - 42.50	12.00 - 42.50	12.00 - 42.50	14.00 - 42.50

AMG	13, 16	13, 19	13, 22	13, 16	13, 19	13, 22	ISO
1.1	■110W	■110W	■100U	■110W	■110V	■100U	P 1
1.2	■100W	■100V	■90U	■100W	■100V	■90U	P 1
1.3	■100W	■100V	■90U				P 2
1.4	■85W	■85V	■75U				P 3
1.5	■85W	■85V	■75U				P 4
1.6	■60T	■60T	■60S				H 1
1.7							H 3
1.8							H 4
2.1				■60V	■50V	■45U	M 1
2.2				■50T	■50S	■40S	M 3
2.3				■40T	■40S	■35S	M 2
2.4	■35T	■35T	■30S	■35T	■35T	■30S	S 2
3.1				■120V	■114V	■106U	K 1
3.2				■116V	■108V	■100U	K 2
3.3	■88V	■85V	■80U	■88V	■85V	■80U	K 3
3.4	■88V	■85V	■80U	■88V	■85V	■80U	K 4
4.1				■45T	■45T	■35S	S 1
4.2				■35T	■35T	■30S	S 2
4.3				■30S	■30S	■25S	S 3
5.1				■35T	■35T	■30S	S 1
5.2				■30S	■30S	■25S	S 2
5.3				■25S	■25S	■20S	S 3
6.1							N 3
6.2							N 4
6.3							N 3
6.4							N 4
7.1							N 1
7.2							N 1
7.3							N 1
7.4							N 2
8.1							O
8.2							O
8.3							O
9.1							H
10.1							O

材料	Material	Material	Material
标准	Norma	Estándar	Standard
深度	Profundidade	Profundidad	Depth
顶角	Ângulo de Ponta	° de la punta	Point Angle
涂层	Tratamento	Tratamiento superficial	Coating
柄部	Haste	Mango	Shank
形式	Forma	Forma	Form
加工方向	Direção	Dirección	Direction
冷却	Refrigeração	Refrigeración	Coolant
镗孔度数	° de Escareado	° de avellanado	Countersink °
■ 性能卓越	Excelente para a Aplicação	Excelente para Aplicación	Excellent for Application
● 性能良好	Bom para a Aplicação	Bueno para Aplicación	Good for Application
实例 10 = 外缘处的切削速度, 米/分, +/- 10%	Exemplo 10 = Velocidade periférica em metros/minuto +/- 10%	Ejemplo 10 = Velocidad Periférica en metros/minuto +/- 10%	Example 10 = Peripheral speed in metres/minute +/- 10%
产品型号	Código	Código de producto	Product Codes
尺寸范围	Gama de medidas	Rango de Diámetros	Size Range

AMG	中文	Português	Español	English
1.1	铁磁性低碳钢	Aço macio magnético	Acero blando	Magnetic soft steel
1.2	结构钢, 表面渗碳钢	Aço estrutural, Aço cementado	Acero de construcción/cementación	Structural steel, case carburizing steel
1.3	普通碳钢	Aço-carbono	Acero al carbono	Plain Carbon steel
1.4	合金钢	Aço de liga	Acero aleado	Alloy steel
1.5	合金钢, 淬火回火钢	Aço de liga, Aço temperado	Acero aleado/temple y revenido	Alloy steel, Hardened and tempered steel
1.6	合金钢, 淬火回火钢	Aço de liga, Aço temperado	Acero aleado/temple y revenido	Alloy steel, Hardened and tempered steel
1.7	热处理合金钢	Aço de liga temperado	Acero aleado cementado	Alloy steel, Heat treated
1.8	淬火合金钢, 耐磨钢	Aço de liga temperado	Acero aleado cementado	Alloy steel, Hardened & Wear resistant steel
2.1	易切削不锈钢	Aço inoxidável de maquinação fácil	Acero inoxidable fácil mecanizado	Free machining, Stainless Steel
2.2	奥氏体不锈钢	Austenítico	Austenítico	Austenitic
2.3	铁素体 + 奥氏体, 马氏体不锈钢	Ferrítico + Austenítico + Martensítico	Ferrítico, Ferr. + Aust., Marten	Ferritic + Austenitic, Ferritic, Martensitic
2.4	沉淀硬化不锈钢	Aço inoxidável de fácil usinagem	Acero Inoxidable Templado	Precipitation Hardened
3.1	灰铸铁	Grafite laminar	Con grafito laminar	Lamellar graphite
3.2	灰铸铁	Grafite laminar	Con grafito laminar	Lamellar graphite
3.3	球墨铸铁, 可锻铸铁	Grafite nodular/ Ferro fundido maleável	Con graf. laminar, fundic. maleable	Nodular graphite, Malleable Cast Iron
3.4	球墨铸铁, 可锻铸铁	Grafite nodular/ Ferro fundido maleável	Con graf. laminar, fundic. maleable	Nodular graphite, Malleable Cast Iron
4.1	纯钛	Titânio, sem liga	Titanio no aleado	Titanium, unalloyed
4.2	钛合金	Titânio, com liga	Titanio aleado	Titanium, alloyed
4.3	钛合金	Titânio, com liga	Titanio aleado	Titanium, alloyed
5.1	纯镍	Níquel, sem liga	Níquel no aleado	Nickel, unalloyed
5.2	镍合金	Níquel, com liga	Níquel aleado	Nickel, alloyed
5.3	镍合金	Níquel, com liga	Níquel aleado	Nickel, alloyed
6.1	紫铜	Cobre	Cobre	Copper
6.2	β黄铜, 青铜	Latão beta, bronze	β-Latón, bronce	β-Brass, Bronze
6.3	α黄铜	Latão alfa	α-Latón	α-Brass
6.4	高强度青铜	Bronze de alta resistência	Metal AMPCO	High Strength Bronze
7.1	纯铝, 纯镁	Al, Mg, sem liga	Al, Mg, no aleado	Al, Mg, unalloyed
7.2	铝合金, 硅含量 < 0.5%	Al com liga, Si<0.5%	Al aleado con Si < 0.5%	Al alloyed, Si < 0.5%
7.3	铝合金, 硅含量 > 0.5% < 10%	Al com liga, Si>0.5%<10%	Al aleado con Si > 0.5% < 10%	Al alloyed, Si > 0.5% < 10%
7.4	铝合金, 硅含量 > 10% 晶须增强铝合金, 镁合金	Al com liga, Si>10% reforçadas com monocristais filiformes, ligas de Al/Mg	Al aleado, Si>10% Reforzado por filamentos, Al-aleados, Mg-aleados	Al alloyed, Si > 10% Whisker reinforced Al-alloys Mg-alloys
8.1	热塑性塑料	Termoplásticos	Termoplásticos	Thermoplastics
8.2	热固性塑料	Plásticos termóduros	Plásticos endurecidos por calor	Thermosetting plastics
8.3	增强塑料	Materiais plásticos reforçados	Materiales plásticos reforzados	Reinforced plastic materials
9.1	金属陶瓷	Cerametal (metalocerâmica)	Cerametales (metales-cerámicas)	Cermets (metals-ceramics)
10.1	标准石墨	Grafite standard	Grafito standard	Graphite

	HSS HM	HSS-E	HSS-E	HSS-E	HSS	HSS	HSS	HSS	HSS	HSS-E	HSS	HSS HM	HSS	HSS-E	HSS-E	HSS-E	HSS-E	
	DIN 8037	DIN 1899	DIN ANSI	DIN ANSI	DIN 338	DIN 338	DIN 338	DIN 338	DIN 338	DIN 338	DORMER	DIN 338	DIN 338	DORMER	DORMER	DIN ANSI	DIN ANSI	
	2.5XD	2.5XD	3XD	3XD	4XD	4XD	4XD	4XD	4XD	4XD	4XD	4XD	4XD	5XD	5XD	6XD	6XD	
	118°	118°	130°	130°	118°	118°	118°	118°	135°	135°	118°	118°	130°	130°	130°	130°	130°	
	ST			Alcona Top	TN	TN	ST	ST	ST	ST	ST	ST	TN	TAIN Top	TAIN Top		Alcona Top	
	H	N	W	W	N	N	N	N	N	W	N	N					W	W
	A124	A720	A920	A921	A002	A002S	A100	A101	A108	A777	A170	A160	A510	A553	A554	A900	A901	
	3.00 - 16.00	0.15 - 1.40	1.00 - 20.00	2.50 - 16.00	1.00 - 16.00	2.00 - 13.00	0.20 - 20.00	1.00 - 12.00	1.00 - 16.00	0.30 - 16.00	13.00 - 1.1/2	4.00 - 16.00	3.00 - 14.00	5.00 - 20.00	20.50 - 30.00	1.00 - 20.00	1.50 - 16.00	
AMG	54	55	56	56	60	60	64	64	64	64	71	73	74	77	77	79	79	ISO
1.1		35A	40J	60M	47J	47J	35H	35H	35I	35J	35H	60E	57M	35L	85L	38H	60J	P 1
1.2		30A	34J	52M	40J	40J	30H	30H	30I	30H	60E	60E	47M	70L	70L	33H	50J	P 1
1.3		27A	32I	53J	35F	35F	25F	25F	25G	27G	25F	55D	40K	60L	60L	26H	44I	P 2
1.4		23A	32I	53J	30F	30F	20F	20F	20F	24F	20E	50D	30H	45H	45H	26H	44I	P 3
1.5	40C	17A	23E	38G	18F	18F	13E	13E	13E	17E	13D	40C	21F	28F	28F	21E	33G	P 4
1.6	37A	10A	19E	30G	10E	10E	9D	9D	9D	10D	9C	37A	11D	15D	15D	16E	26G	H 1
1.7																		H 3
1.8																		H 4
2.1		22A	15F	17F	20F	20F	15E	15E	15E	22E	15D	40B	28G	40G	40G	15E	17E	M 1
2.2	35C	10A	7F	9F	12G	12G	8G	8G	9G	11G	7F	35C	14I	19I	19I	7E	9E	M 3
2.3	35C	15A	9D	11D	16C	16C	9C	9C	10D	15C	7B	35A	19G	27G	27G	9C	11C	M 2
2.4																		S 2
3.1	55C	30A	34L	53L	40J	40J	30H	30H	30H	35H	27H	50C	42K	70K	70K	24J	58I	K 1
3.2	43C	24A	26L	42L	30E	30E	24F	24F	24F	28D	22E	40A	32J	50J	50J	19J	47I	K 2
3.3	40C	20A	26L	42L	28E	28E	20E	20E	20E	22E	19D	35A	28J	45J	45J	19J	34J	K 3
3.4	32A	14A	19J	36J	26E	26E	14E	14E	14E	17E	12D	30A	25F	42F	42F	14I	28I	K 4
4.1	40A	23A	30G	48I	23F	23F	23E	23E	25G	28F	17E	35A	32G	45G	45G	22E	35G	S 1
4.2	35A	17A	18G	29I	13D	13D	12D	12D	16E	20D	9C	35A	20H	30E	30E	15E	24G	S 2
4.3	25A	8A	10C	16E	7B	7B	6B	6B	7B	11C	5A	25A	4B	8C	8C	6C	10E	S 3
5.1	30A	10A	15I	24L	13G	13G	10G	10G	12G	15G	8F	30A	17I	25I	25I	14G	22I	S 1
5.2	25A	7A	9G	14I	7E	7E	6E	6E	7G	7E	4D	25A	9E	15E	15E	7G	11I	S 2
5.3	20A	4A	6E	10G	3A	3A	3A	3A	6E	6B	3A	20A	6E	10G	10G	6C	10E	S 3
6.1		35A	65H		50G	50G	33G	33G	33G	38H	35F	55D	40D	70G	70G	65G		N 3
6.2	70G	40A	66J		33I	33I	35I	35I	35I	40F	33H	70G	50I	85I	85I	53I		N 4
6.3	60E	35A	40J	71J	39H	39H	27H	27H	31H	27H	27G	60C	45I	80I	80I	34H	56I	N 3
6.4	50C	27A	31G	50I	30G	30G	16G	16G	16G	21F	16F	50C	20F	35G	35G	30G	48I	N 4
7.1		35A	75L		41K	41K	33J	33J	33J	33J	33I	50I	50G	70H	70H	60J		N 1
7.2		30A	45N		38J	38J	30I	30I	30I	30I	30H	45H	50M	100M	100M	45N		N 1
7.3		27A	40N		33I	33I	27H	27H	27H	30H	27G	40G	31I	55I	55I	40N		N 1
7.4		27A	36J	48J	33I	33I	24F	24F	24F	27F	22G	35F	33I	55I	55I	28I	48I	N 2
8.1		48A	55J		30I	30I	30J	30J	30J	30J	30I		65G	90G	90G	55I		O
8.2	60E	25A	40H		50H	50H	28H	28H	28H	28H	28G	60E	50G			40G		O
8.3					35F	35F	14F	14F	14F	14F	14E		35F					O
9.1	9C				3B	3B	3B	3B	3B	3B	6C	3A	9C					H
10.1																		O

	HSS	HSS	HSS	HSS-E	HSS-E	HSS	HSS-E	HSS-E	HSS-E	HSS	HSS	HSS-E	HSS HM	HSS	HSS	HSS
	NAS 907	NAS 907	DIN 340	DIN ANSI	DIN ANSI	BS 328	DIN 1869/1	DIN 1869/2	DIN 1869/3	DIN 345	DIN 345	DIN 345	DIN 345	DIN 341	DIN 1870/1	DIN 1870/1
	4XD	4XD	6XD	10XD	10XD	10XD	15XD	20XD	25XD	4XD	4XD	4XD	4XD	6XD	10XD	15XD
	135°	118°	118°	130°	130°	118°	130°	130°	130°	118°	118°	118°	118°	118°	118°	130°
	A243	A244	A110	A940	A941	A125	A976	A977	A978	A130	A530	A730	A166	A350	A345	A951
	3/32 - 1/4	1/8 - 1/4	0.50 - 1"	1.00 - 20.00	1.00 - 16.00	1.40 - 1"	1.50 - 14.00	1.50 - 14.00	3.00 - 10.00	2.00 - 100.00	8.50 - 40.00	10.00 - 32.00	10.00 - 33.00	5.00 - 50.00	8.00 - 50.00	10.00 - 30.00

AMG	83	83	84	87	87	90	94	94	94	97	97	97	103	104	106	108	ISO
1.1			27G	38F	53G	24E	31C	31B	31A	35I	47I	35J	60E	27I	24G	27G	P 1
1.2			25G	33F	46G	22E	26C	26B	26A	30I	40I	30H	60E	25I	22G	22G	P 1
1.3	25F	25F	20E	22G	36G	16C	22C	22B	22A	25F	30F	27G	55D	20G	17E	19E	P 2
1.4	20F	20F	16E	22G	36G	15C	22C	22B	22A	20F	27F	23F	50D	16F	15D	15D	P 3
1.5	13E	13E	9D	17C	23D	6A	12A	12A	12A	12E	20E	17E	40C	10E	6C	8C	P 4
1.6	9D	9D	6B	12C	17D	5A	10A	10A	10A	9D	10D	10D	37A	6D	5B	6B	H 1
1.7																	H 3
1.8																	H 4
2.1	15E	15E	10D	15C	17C	9C	12B	12B	12A	15E	24E	24E	40B	13E	12C	12C	M 1
2.2	3G	3G	6F	7E	9E	4E	7C	7B	7A	9G	13G	11G	35C	4G	4E	6E	M 3
2.3	9C	9C	4B	9B	11B	8A	8A	8A	8A	10C	20C	17C	35A	8C	8A	12A	M 2
2.4																	S 2
3.1	30I	30I	28H		36I	22G				30I	36I	35J	50C	26I	22G	22G	K 1
3.2	24F	24F	21E	16I	30I	18D	23C	23B	23A	24E	28E	28G	40C	20F	18D	16D	K 2
3.3	20E	20E	15D	16I	30I	13C	16C	16B	16A	20E	27E	22E	35C	18E	13C	13C	K 3
3.4	14E	14E	13D	12H	24H	9C	11A	11A	11A	14E	22E	17E	30A	11E	9C	9C	K 4
4.1	23F	23F	17E	18E	25F	11D	15C	15B	15A	23F	32F	28G	35A	16F	15D	18D	S 1
4.2	12D	12D	9C	13C	18D	9B	11A	11A	11A	13D	18D	20D	35A	9D	9B	10B	S 2
4.3	6B	6B	4A	6C	8D	5A	5A	5A	5A	7B	13B	11C	25A	5B	5A	6A	S 3
5.1	10G	10G	8F			5E				10G	13G	15G	30A	8G	8E	7E	S 1
5.2	6E	6E	4D			4C				7E	6E	7E	25A	4E	4C	5C	S 2
5.3	3A	3A	3A			3A				4A	3A	6B	20A	3A	3A	3A	S 3
6.1			30E	65F		24D				33F	60G	38L	55D	33F	27D	22D	N 3
6.2			32H	70F		33G				35I	55I	40J	75G	35I	33G	33G	N 4
6.3	27H	27H	27G	34G	48H	22F	30D	30C	30B	35H	40G	27H	60C	35H	27F	22F	N 3
6.4	16G	16G	16E	30G	42H	16D	27D	27C	27B	16F	35E	21F	50C	16F	16D	16D	N 4
7.1			32I	53H		24H				26J	55I	33J	50I	33J	33H	30H	N 1
7.2			27H	45N		22G				30I	45I	30I	45H	25I	27G	27G	N 1
7.3			27G	40N		22F				28H	35G	30H	40G	27H	27F	24F	N 1
7.4	24F	24F	25E	30G	42H	20E	27D	27C	27B	23H	28G	27F	35F	25H	24F	22F	N 2
8.1			35I	55H		30H				30K	50J	35K		35L	30J	30J	O
8.2			26G	40F		26F				28J	50H	28J	60E	26J	30H	30H	O
8.3			12E			10D				14H	35F	20H		12H	10F	10F	O
9.1	3B	3B	3A			3A				3B	3B	5C	9C	3B	3A	3A	H
10.1																	O

	HSS	HSS	HSS	HSS	HSS	HSS	HSS	HSS	HSS	HSS	HSS				
	DIN 1870/2	DIN 8374	DIN 8376	DIN 8377	DORMER	DORMER	DIN 333A	DIN 333A	DIN 333R	DORMER	BS 328				
	20XD	4XD	4XD	4XD	2.5XD	2.5XD	1XD	1XD	1XD	1XD	1XD				
	130°	118°	118°	118°	118°	118°	118°	118°	118°	118°	122°	120°			
	ST	ST	ST	ST	ST	ST		TN							
	W	N	N	N											
	A952	A400	A402	A405	A412	A413	A200	A205	A210	A201	A225	A088	A095	A099	
	8.00 - 40.00	M3 - M10	M3 - M10	M6 - M18	M3 - M10	M3 - M10	0.50 - 12.50	1.00 - 5.00	0.50 - 10.00	0.63 - 6.00	3/64 - 5/16	Set	Set	Set	
AMG	108	110	111	112	113	114	115	115	116	117	118	119	120	121	ISO
1.1	27G	32G	32G	32G	32I	32I	35I	42I	35I	35I	35I				P 1
1.2	22G	27G	27G	27G	27I	27I	30I	36I	30I	30I	30I				P 1
1.3	19E	22E	22E	22E	22G	22G	25G	30G	25G	25G	25G				P 2
1.4	15D	20E	20E	20E	20G	20G	20F	24F	20F	20F	20F				P 3
1.5	8C	10C	10C	10C	10E	10E	13E	16E	13E	13E	13E				P 4
1.6	6B	6C	6C	6C	6C	6C	9D	11D	9D	9D	9D				H 1
1.7															H 3
1.8															H 4
2.1	12C	16E	16E	16E	16G	16G	15E	18E	15E	15E	15E				M 1
2.2	6E	9G	9G	9G	9I	9I	8G	10G	8G	8G	8G				M 3
2.3	12A	12C	12C	12C	12E	12E	10C	12C	10C	10C	10C				M 2
2.4															S 2
3.1	22G	30G	30G	30G	30G	30G	30I	36I	30I	30I	30I				K 1
3.2	16D	25E	25E	25E	25E	25E	24F	29F	24F	24F	24F				K 2
3.3	13C	19E	19E	19E	19E	19E	20E	24E	20E	20E	20E				K 3
3.4	9C	18C	18C	18C	18E	18E	14E	17E	14E	14E	14E				K 4
4.1	18D	23E	23E	23E	27G	27G	24F	29F	24F	24F	24F				S 1
4.2	10B	14C	14C	14C	16E	16E	13D	16D	13D	13D	13D				S 2
4.3	6A	8A	8A	8A	8C	8C	7B	8B	7B	7B	7B				S 3
5.1	7E	10G	10G	10G	13I	13I	10G	12G	10G	10G	10G				S 1
5.2	5C	6C	6C	6C	8G	8G	5E	6E	5E	5E	5E				S 2
5.3	3A	4A	4A	4A	4C	4C	4A	5A	4A	4A	4A				S 3
6.1	22D	35E	35E	35E	35G	35G	35G	42G	35G	35G	35G				N 3
6.2	33G	40E	40E	40E	40G	40G	33I	40I	33I	33I	33I				N 4
6.3	22F	32E	32E	32E	32G	32G	27H	32H	27H	27H	27H				N 3
6.4	16D	20E	20E	20E	20G	20G	16G	19G	16G	16G	16G				N 4
7.1	30H	45E	45E	45E	45G	45G	33J	40J	33J	33J	33J				N 1
7.2	27G	32E	32E	32E	32G	32G	30I	36I	30I	30I	30I				N 1
7.3	24F	32E	32E	32E	27G	27G	27H	32H	27H	27H	27H				N 1
7.4	22F	25E	25E	25E	25G	25G	22H	26H	22H	22H	22H				N 2
8.1	30J	30I	30I	30I	30I	30I	30J	36J	30J	30J	30J				O
8.2	30H						28H	34H	28H	28H	28H				O
8.3	10F						14F	17F	14F	14F	14F				O
9.1	3A						3B	4B	3B	3B	3B				H
10.1															O



A190
Set



A094
Set
NEW



A191
Set



A199
Set



A295
Set



A296
Set

AMG	122	123	124	125	126	127	ISO
1.1							P 1
1.2							P 1
1.3							P 2
1.4							P 3
1.5							P 4
1.6							H 1
1.7							H 3
1.8							H 4
2.1							M 1
2.2							M 3
2.3							M 2
2.4							S 2
3.1							K 1
3.2							K 2
3.3							K 3
3.4							K 4
4.1							S 1
4.2							S 2
4.3							S 3
5.1							S 1
5.2							S 2
5.3							S 3
6.1							N 3
6.2							N 4
6.3							N 3
6.4							N 4
7.1							N 1
7.2							N 1
7.3							N 1
7.4							N 2
8.1							O
8.2							O
8.3							O
9.1							H
10.1							O

Fn	HM				HSS HM		HSS		HSS-E							
	Ø(D)	1mm	2mm	3mm	4mm	5mm	6mm	8mm	10mm	12mm	15mm	16mm	20mm	25mm	30mm	40mm
A	0.012	0.023	0.029	0.032	0.036	0.042	0.054	0.062	0.069	0.082	0.086	0.110	0.125	0.135	0.155	0.175
B	0.014	0.028	0.037	0.041	0.046	0.053	0.067	0.080	0.090	0.103	0.108	0.135	0.153	0.165	0.188	0.208
C	0.015	0.032	0.044	0.050	0.056	0.064	0.080	0.098	0.110	0.125	0.130	0.160	0.180	0.195	0.220	0.240
D	0.016	0.038	0.053	0.060	0.068	0.078	0.098	0.119	0.130	0.149	0.155	0.188	0.210	0.228	0.253	0.275
E	0.017	0.043	0.062	0.071	0.080	0.092	0.115	0.140	0.150	0.173	0.180	0.215	0.240	0.260	0.285	0.310
F	0.018	0.050	0.073	0.084	0.095	0.109	0.138	0.165	0.178	0.202	0.210	0.248	0.275	0.295	0.320	0.343
G	0.019	0.056	0.084	0.096	0.109	0.126	0.160	0.190	0.205	0.231	0.240	0.280	0.310	0.330	0.355	0.375
H	0.020	0.066	0.102	0.116	0.130	0.150	0.190	0.228	0.243	0.271	0.280	0.320	0.355	0.375	0.398	0.418
I	0.021	0.076	0.119	0.134	0.150	0.173	0.220	0.265	0.280	0.310	0.320	0.360	0.400	0.420	0.440	0.460
J	0.024	0.084	0.135	0.152	0.170	0.197	0.250	0.298	0.315	0.349	0.360	0.405	0.445	0.465	0.485	0.503
K	0.026	0.092	0.150	0.170	0.190	0.220	0.280	0.330	0.350	0.388	0.400	0.450	0.490	0.510	0.530	0.545
L	0.028	0.101	0.165	0.186	0.208	0.240	0.305	0.360	0.385	0.419	0.430	0.485	0.525	0.545	0.568	0.588
M	0.030	0.110	0.180	0.202	0.225	0.260	0.330	0.390	0.420	0.450	0.460	0.520	0.560	0.580	0.605	0.630
N	0.032	0.119	0.195	0.218	0.242	0.280	0.355	0.420	0.455	0.481	0.490	0.555	0.595	0.615	0.642	0.672
S	0.008	0.014	0.020	0.025	0.030	0.037	0.050	0.080	0.100	0.123	0.130	0.150				
T	0.015	0.028	0.040	0.050	0.060	0.070	0.090	0.110	0.130	0.160	0.170	0.190				
U	0.026	0.048	0.070	0.080	0.090	0.107	0.140	0.170	0.200	0.223	0.230	0.240				
V	0.038	0.069	0.100	0.115	0.130	0.153	0.200	0.250	0.280	0.310	0.320	0.340				
W	0.049	0.089	0.130	0.150	0.170	0.200	0.260	0.330	0.380	0.418	0.430	0.450				
X	0.056	0.103	0.150	0.180	0.210	0.250	0.330	0.420	0.480	0.533	0.550	0.580				
Y	0.068	0.124	0.180	0.220	0.260	0.317	0.430	0.550	0.700	0.700	0.700	0.740				
Z	0.094	0.172	0.250	0.325	0.400	0.533	0.800	1.000	1.100	1.175	1.200	1.200				

mm/REV ± 25%

$$n = \frac{V_c \times 1000}{\pi \times D}$$

$$V_f = n \times f_n$$

Fn	HM						
Ø(D)	12mm	15mm	16mm	20mm	25mm	30mm	40mm
S	0.100	0.123	0.130	0.150	0.170	0.190	0.220
T	0.130	0.160	0.170	0.190	0.210	0.230	0.260
U	0.200	0.223	0.230	0.240	0.270	0.300	0.360
V	0.280	0.310	0.320	0.340	0.400	0.440	0.510
W	0.380	0.418	0.430	0.450	0.470	0.490	0.520

mm/REV ± 25%



R950

- 适用于钢件的天龙钻头
- Cabeça Hydra para Aço
- punta Hydra para Acero
- Hydra Drill Head for Steel

钻头刀体内包括 4 螺钉 H860 和 1 螺丝刀 H861

Quatro (4) parafusos H860 e uma (1) chave H861 estão inclusos com o corpo da broca
Cuatro (4) tornillos H860 y un (1) destornillador H861 incluidos con cada cuerpo
Four (4) screws H860 and one (1) screwdriver H861 are included with a drill body

R960

- 适用于不锈钢的天龙钻头
- Cabeça Hydra para Aço Inoxidável
- punta Hydra para Acero Inoxidable
- Hydra Drill Head for Stainless Steel

钻头刀体内包括 4 螺钉 H860 和 1 螺丝刀 H861

Quatro (4) parafusos H860 e uma (1) chave H861 estão inclusos com o corpo da broca
Cuatro (4) tornillos H860 y un (1) destornillador H861 incluidos con cada cuerpo
Four (4) screws H860 and one (1) screwdriver H861 are included with a drill body

R950	▪	1.3	1.4	1.5	3.3	3.4				
	•	1.1	1.2	1.6	2.4					
R960	▪	1.1	1.2	2.1	2.2	2.3	3.1	3.2		
	•	2.4	3.3	3.4	4.1	4.2	4.3	5.1	5.2	5.3

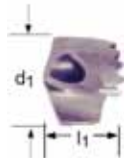

d_1 Øh7 Inch	d_1 Øh7 mm	d_1 decimal Inch	l_1 mm	R950	R960
15/32	11.91	0.4688	9.1	R95015/32	R96015/32
	12.00	0.4724	9.1	R95012.0	R96012.0
	12.10	0.4764	9.1	R95012.1	R96012.1
	12.20	0.4803	9.1	R95012.2	R96012.2
31/64	12.30	0.4844	9.1	R95031/64	R96031/64
	12.50	0.4921	9.4	R95012.5	R96012.5
	12.60	0.4961	9.4	R95012.6	R96012.6
1/2	12.70	0.5000	9.4	R9501/2	R9601/2
	12.80	0.5039	9.4	R95012.8	R96012.8
	12.90	0.5079	9.4	R95012.9	R96012.9
	13.00	0.5118	9.7	R95013.0	R96013.0
33/64	13.10	0.5156	9.7	R95033/64	R96033/64
	13.20	0.5197	9.7	R95013.2	R96013.2
17/32	13.49	0.5313	9.7	R95017/32	R96017/32
	13.50	0.5315	10.3	R95013.5	R96013.5
	13.60	0.5354	10.3	R95013.6	R96013.6
	13.70	0.5394	10.3	R95013.7	R96013.7
	13.80	0.5433	10.3	R95013.8	R96013.8
35/64	13.89	0.5469	10.3	R95035/64	R96035/64
	14.00	0.5512	10.3	R95014.0	R96014.0
	14.10	0.5551	10.3	R95014.1	R96014.1
	14.20	0.5591	10.3	R95014.2	R96014.2
9/16	14.29	0.5625	10.3	R9509/16	R9609/16
	14.50	0.5709	10.3	R95014.5	R96014.5
	14.60	0.5748	11.0	R95014.6	R96014.6
37/64	14.68	0.5781	11.0	R95037/64	R96037/64
	14.70	0.5787	11.0	R95014.7	R96014.7
	14.80	0.5827	11.0	R95014.8	R96014.8

d_1 Øh7 Inch	d_1 Øh7 mm	d_1 decimal Inch	l_1 mm	R950	R960
	15.00	0.5906	11.0	R95015.0	R96015.0
19/32	15.08	0.5938	11.0	R95019/32	R96019/32
	15.10	0.5945	11.0	R95015.1	R96015.1
	15.20	0.5984	11.0	R95015.2	R96015.2
39/64	15.48	0.6094	11.0	R95039/64	R96039/64
	15.50	0.6102	11.0	R95015.5	R96015.5
	15.60	0.6142	11.6	R95015.6	R96015.6
	15.70	0.6181	11.6	R95015.7	R96015.7
5/8	15.88	0.6250	11.6	R9505/8	R9605/8
	16.00	0.6299	11.6	R95016.0	R96016.0
	16.10	0.6339	11.6	R95016.1	R96016.1
	16.20	0.6378	11.6	R95016.2	R96016.2
41/64	16.27	0.6406	11.6	R95041/64	R96041/64
	16.50	0.6496	11.6	R95016.5	R96016.5
	16.60	0.6535	12.2	R95016.6	R96016.6
21/32	16.67	0.6563	12.2	R95021/32	R96021/32
	16.70	0.6575	12.2	R95016.7	R96016.7
	17.00	0.6693	12.2	R95017.0	R96017.0
43/64	17.07	0.6719	12.2	R95043/64	R96043/64
	17.10	0.6732	12.2	R95017.1	R96017.1
	17.20	0.6772	12.2	R95017.2	R96017.2
11/16	17.46	0.6875	12.2	R95011/16	R96011/16
	17.50	0.6890	12.2	R95017.5	R96017.5
	17.60	0.6929	12.9	R95017.6	R96017.6
	17.70	0.6969	12.9	R95017.7	R96017.7
45/64	17.86	0.7031	12.9	R95045/64	R96045/64
	18.00	0.7087	12.9	R95018.0	R96018.0
	18.10	0.7126	12.9	R95018.1	R96018.1
	18.20	0.7165	12.9	R95018.2	R96018.2
23/32	18.26	0.7188	12.9	R95023/32	R96023/32
	18.50	0.7283	12.9	R95018.5	R96018.5
	18.60	0.7323	13.5	R95018.6	R96018.6
47/64	18.65	0.7344	13.5	R95047/64	R96047/64
	18.70	0.7362	13.5	R95018.7	R96018.7
	18.90	0.7441	13.5	R95018.9	R96018.9
	19.00	0.7480	13.5	R95019.0	R96019.0
3/4	19.05	0.7500	13.5	R9503/4	R9603/4
	19.10	0.7520	13.5	R95019.1	R96019.1
	19.20	0.7559	13.5	R95019.2	R96019.2
	19.25	0.7579	13.5	R95019.25	R96019.25
49/64	19.45	0.7656	13.5	R95049/64	R96049/64
	19.50	0.7677	13.5	R95019.5	R96019.5
	19.60	0.7717	14.1	R95019.6	R96019.6
	19.70	0.7756	14.1	R95019.7	R96019.7
25/32	19.84	0.7813	14.1	R95025/32	R96025/32
	20.00	0.7874	14.1	R95020.0	R96020.0
51/64	20.24	0.7969	14.1	R95051/64	R96051/64
	20.50	0.8071	14.1	R95020.5	R96020.5
13/16	20.64	0.8125	14.8	R95013/16	R96013/16
	21.00	0.8268	14.8	R95021.0	R96021.0
53/64	21.03	0.8281	14.8	R95053/64	R96053/64
27/32	21.43	0.8438	14.8	R95027/32	R96027/32
	21.50	0.8465	14.8	R95021.5	R96021.5
55/64	21.83	0.8594	15.0	R95055/64	R96055/64
	22.00	0.8661	15.0	R95022.0	R96022.0
7/8	22.22	0.8750	15.0	R9507/8	R9607/8
	22.50	0.8858	15.0	R95022.5	R96022.5
57/64	22.62	0.8906	15.0	R95057/64	R96057/64
	22.70	0.8937	15.0	R95022.7	R96022.7
	23.00	0.9055	15.1	R95023.0	R96023.0
29/32	23.02	0.9063	15.1	R95029/32	R96029/32
59/64	23.42	0.9219	15.1	R95059/64	R96059/64
	23.50	0.9252	15.1	R95023.5	R96023.5
15/16	23.81	0.9375	15.4	R95015/16	R96015/16
	24.00	0.9449	15.4	R95024.0	R96024.0
61/64	24.21	0.9531	15.4	R95061/64	R96061/64
	24.50	0.9646	15.4	R95024.5	R96024.5
31/32	24.61	0.9688	15.4	R95031/32	R96031/32
	25.00	0.9844	15.8	R95025.0	R96025.0
63/64	25.00	0.9844	15.8	R95063/64	R96063/64

d ₁ Øh7 Inch	d ₁ Øh7 mm	d ₁ decimal Inch	l ₁ mm	R950	R960
1"	25.40	1.0000	15.8	R9501	R9601
	25.50	1.0039	15.8	R95025.5	R96025.5
	25.65	1.0098	15.8	R95025.65	R96025.65
1.1/64	25.80	1.0156	15.8	R9501.1/64	R9601.1/64
	26.00	1.0236	16.4	R95026.0	R96026.0
1.1/32	26.19	1.0313	16.4	R9501.1/32	R9601.1/32
	26.50	1.0433	16.4	R95026.5	R96026.5
1.3/64	26.59	1.0469	16.4	R9501.3/64	R9601.3/64
1.1/16	26.99	1.0625	17.1	R9501.1/16	R9601.1/16
	27.00	1.0630	17.1	R95027.0	R96027.0
1.5/64	27.38	1.0781	17.1	R9501.5/64	R9601.5/64
	27.50	1.0827	17.1	R95027.5	R96027.5
1.3/32	27.78	1.0938	17.1	R9501.3/32	R9601.3/32
	28.00	1.1024	17.7	R95028.0	R96028.0
1.7/64	28.18	1.1094	17.7	R9501.7/64	R9601.7/64
	28.50	1.1220	17.7	R95028.5	R96028.5
1.1/8	28.58	1.1250	17.7	R9501.1/8	R9601.1/8
1.9/64	28.97	1.1406	18.3	R9501.9/64	R9601.9/64
	29.00	1.1417	18.3	R95029.0	R96029.0
1.5/32	29.37	1.1563	18.3	R9501.5/32	R9601.5/32
	29.50	1.1614	18.3	R95029.5	R96029.5
1.11/64	29.77	1.1719	18.3	R9501.11/64	R9601.11/64
	30.00	1.1811	19.0	R95030.0	R96030.0
1.3/16	30.16	1.1875	19.0	R9501.3/16	R9601.3/16
	30.50	1.2008	19.0	R95030.5	R96030.5
1.7/32	30.96	1.2188	21.0	R9501.7/32	
	31.00	1.2205	21.0	R95031.0	
1.1/4	31.75	1.2500	21.0	R9501.1/4	
	32.00	1.2598	21.0	R95032.0	
	32.50	1.2795	21.0	R95032.5	
1.19/64	32.94	1.2969	21.0	R9501.19/64	
	33.00	1.2992	21.0	R95033.0	
	33.50	1.3189	21.0	R95033.5	
	34.00	1.3386	23.0	R95034.0	
1.11/32	34.13	1.3438	23.0	R9501.11/32	
	34.50	1.3583	23.0	R95034.5	
1.3/8	34.93	1.3750	23.0	R9501.3/8	
	35.00	1.3780	23.0	R95035.0	
	36.00	1.4173	23.0	R95036.0	
1.27/64	36.12	1.4219	23.0	R9501.27/64	
	36.50	1.4370	23.0	R95036.5	
	37.00	1.4567	25.0	R95037.0	
1.15/32	37.31	1.4688	25.0	R9501.15/32	
	37.50	1.4764	25.0	R95037.5	
	38.00	1.4961	25.0	R95038.0	
1.1/2	38.10	1.5000	25.0	R9501.1/2	
	38.50	1.5157	25.0	R95038.5	
1.17/32	38.89	1.5313	25.0	R9501.17/32	
	39.00	1.5354	25.0	R95039.0	
	39.50	1.5551	25.0	R95039.5	
1.9/16	39.69	1.5625	27.0	R9501.9/16	
	40.00	1.5748	27.0	R95040.0	
	41.00	1.6142	27.0	R95041.0	
1.5/8	41.28	1.6250	27.0	R9501.5/8	
	42.00	1.6535	27.0	R95042.0	

H853

HSS

DORMER

3XD

DIN
6535HB
DIN
6535HE

H853

- 天龙钻头体 3 x D
- Corpos Hydra 3 x D
- Cuerpo Hydra 3 x D
- Hydra Body 3 x D



钻头刀体内包括 4 螺钉 H860 和 1 螺丝刀 H861

Quatro (4) parafusos H860 e uma (1) chave H861estão inclusos com o corpo da broca



Cuatro (4) tornillos H860 y un (1) destornillador H861 incluidos con cada cuerpo



Four (4) screws H860 and one (1) screwdriver H861 are included with a drill body

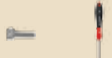

d_1	l_2	l_1	l_3	d_2 Øh6 mm	H853	H860N1	H861N1
15/32							
12.00							
12.10	44.0	105.0	48.0	16.00	H85312.0		
12.20							
31/64							
12.50							
12.60							
1/2	44.0	105.0	48.0	16.00	H85312.5		
12.80							
12.90							
13.00							
33/64	47.0	110.0	48.0	16.00	H85313.0		
13.20							
17/32							
13.50							
13.60							
13.70							
13.80							
35/64	52.5	116.5	48.0	16.00	H85314.0		
14.00							
14.10							
14.20							
9/16							
14.50							
14.60							
37/64							
14.70							
14.80							
15.00	55.5	126.5	50.0	20.00	H85315.0		
19/32							
15.10							
15.20							
39/64							
15.50							

d_1	l_2	l_1	l_3	d_2 Øh6 mm	d_2 Øh6 inch	H853	H860N1	H861N1
15/32								
12.00								
12.10	44.0	105.0	48.0	15.88	5/8	H85331/64		
12.20								
31/64								
12.50								
12.60								
1/2	44.0	105.0	48.0	15.88	5/8	H8531/2		
12.80								
12.90								
13.00								
33/64	47.0	110.0	48.0	15.88	5/8	H85317/32		
13.20								
17/32								
13.50								
13.60								
13.70								
13.80								
35/64	52.5	116.5	48.0	19.05	3/4	H8539/16		
14.00								
14.10								
14.20								
9/16								
14.50								
14.60								
37/64								
14.70								
14.80								
15.00	55.5	126.5	50.0	19.05	3/4	H85339/64		
19/32								
15.10								
15.20								
39/64								
15.50								

							
d_1	l_2	l_1	l_3	d_2 $\varnothing h6$	H853		
$\varnothing h7$	mm	mm	mm	mm			
15.60							
15.70							
5/8							
16.00	59.5	131.5	50.0	20.00	H85316.0		
16.10							
16.20							
41/64							
16.50							
16.60							
21/32							
16.70							
17.00							
43/64	62.5	136.5	50.0	20.00	H85317.0	H860N2	H861N2
17.10							
17.20							
11/16							
17.50							
17.60							
17.70							
45/64							
18.00	66.5	141.5	50.0	20.00	H85318.0		
18.10							
18.20							
23/32							
18.50							
18.60							
47/64							
18.70							
18.90							
19.00							
3/4	69.5	156.5	56.0	25.00	H85319.0	H860N3	
19.10							
19.20							
19.25							
49/64							
19.50							
19.60							
19.70							
25/32	73.5	156.5	56.0	25.00	H85320.0		
20.00							
51/64							
20.50							
13/16							
21.00	76.5	156.5	56.0	25.00	H85321.0	H861N3	
53/64							
27/32							
21.50							
55/64							
22.00							
7/8	80.1	161.5	56.0	25.00	H85322.0		
22.50							
57/64							
22.70							
23.00							
29/32	82.5	160.5	56.0	25.00	H85323.0	H860N4	
59/64							
23.50							
15/16							
24.00	86.2	170.2	60.0	32.00	H85324.0		
61/64							
24.50							
31/32							

								
d_1	l_2	l_1	l_3	d_2 $\varnothing h6$	d_2 $\varnothing h6$	H853		
$\varnothing h7$	mm	mm	mm	mm	inch			
15.60								
15.70								
5/8								
16.00	59.5	131.5	50.0	19.05	3/4	H85341/64		
16.10								
16.20								
41/64								
16.50								
16.60								
21/32								
16.70								
17.00								
43/64	62.5	136.5	50.0	19.05	3/4	H85311/16	H860N2	H861N2
17.10								
17.20								
11/16								
17.50								
17.60								
17.70								
45/64								
18.00	66.5	141.5	50.0	19.05	3/4	H85323/32		
18.10								
18.20								
23/32								
18.50								
18.60								
47/64								
18.70								
18.90								
19.00								
3/4	69.5	156.5	56.0	25.40	1"	H85349/64	H860N3	
19.10								
19.20								
19.25								
49/64								
19.50								
19.60								
19.70								
25/32	73.5	156.5	56.0	25.40	1"	H85351/64		
20.00								
51/64								
20.50								
13/16								
21.00	76.5	156.5	56.0	25.40	1"	H85327/32	H861N3	
53/64								
27/32								
21.50								
55/64								
22.00								
7/8	80.1	161.5	56.0	25.40	1"	H85357/64		
22.50								
57/64								
22.70								
23.00								
29/32	82.5	160.5	56.0	25.40	1"	H85359/64	H860N4	
59/64								
23.50								
15/16								
24.00	86.2	170.2	60.0	25.40	1"	H85331/32		
61/64								
24.50								
31/32								

H855

HSS

DORMER

5XD

DIN
6535HB
DIN
6535HE

H855

- 天龙钻头体 5 x D
- Corpos Hydra 5 x D
- Cuerpo Hydra 5 x D
- Hydra Body 5 x D



钻头刀体内包括 4 螺钉 H860 和 1 螺丝刀 H861

Quatro (4) parafusos H860 e uma (1) chave H861 estão inclusos com o corpo da broca

Cuatro (4) tornillos H860 y un (1) destornillador H861 incluidos con cada cuerpo

Four (4) screws H860 and one (1) screwdriver H861 are included with a drill body





d_1	l_2	l_1	l_3	d_2 Øh6 mm	H855	H860N1	H861N1
Øh7	mm	mm	mm	mm			
15/32							
12.00							
12.10	69.0	130.0	48.0	16.00	H85512.0		
12.20							
31/64							
12.50							
12.60							
1/2	69.0	130.0	48.0	16.00	H85512.5		
12.80							
12.90							
13.00							
33/64	74.0	140.0	48.0	16.00	H85513.0		
13.20							
17/32							
13.50							
13.60							
13.70							
13.80							
35/64	81.5	146.5	48.0	16.00	H85514.0		
14.00							
14.10							
14.20							
9/16							
14.50							
14.60							
37/64							
14.70							
14.80							
15.00	86.5	156.5	50.0	20.00	H85515.0		
19/32							
15.10							
15.20							
39/64							
15.50							

d_1	l_2	l_1	l_3	d_2 Øh6 mm	d_2 Øh6 inch	H855	H860N1	H861N1
Øh7	mm	mm	mm	mm	inch			
15/32								
12.00								
12.10	69.0	130.0	48.0	15.88	5/8	H85531/64		
12.20								
31/64								
12.50								
12.60								
1/2	69.0	130.0	48.0	15.88	5/8	H8551/2		
12.80								
12.90								
13.00								
33/64	74.0	140.0	48.0	15.88	5/8	H85517/32		
13.20								
17/32								
13.50								
13.60								
13.70								
13.80								
35/64	81.5	146.5	48.0	19.05	3/4	H8559/16		
14.00								
14.10								
14.20								
9/16								
14.50								
14.60								
37/64								
14.70								
14.80								
15.00	86.5	156.5	50.0	19.05	3/4	H85539/64		
19/32								
15.10								
15.20								
39/64								
15.50								

d_1	l_2	l_1	l_3	d_2	H855	
$\varnothing h7$	mm	mm	mm	$\varnothing h6$		
15.60						
15.70						
5/8						
16.00	92.5	166.5	50.0	20.00	H85516.0	
16.10						
16.20						
41/64						
16.50						
16.60						
21/32						
16.70						
17.00	97.5	171.5	50.0	20.00	H85517.0	H860N2
43/64						
17.10						
17.20						
11/16						
17.50						
17.60						
17.70						
45/64						
18.00	103.5	176.5	50.0	20.00	H85518.0	
18.10						
18.20						
23/32						
18.50						
18.60						
47/64						
18.70						
18.90						
19.00	108.5	191.5	56.0	25.00	H85519.0	H860N3
3/4						
19.10						
19.20						
19.25						
49/64						
19.50						
19.60						
19.70						
25/32	114.5	196.5	56.0	25.00	H85520.0	
20.00						
51/64						
20.50						
13/16						
21.00	119.5	196.5	56.0	25.00	H85521.0	H861N3
53/64						
27/32						
21.50						
55/64						
22.00	125.1	201.1	56.0	25.00	H85522.0	
7/8						
22.50						
57/64						
22.70						
23.00						
29/32	129.5	210.5	56.0	25.00	H85523.0	H860N4
59/64						
23.50						
15/16						
24.00	135.2	220.2	60.0	32.00	H85524.0	
61/64						
24.50						
31/32						

d_1	l_2	l_1	l_3	d_2	d_2	H855	
$\varnothing h7$	mm	mm	mm	$\varnothing h6$	$\varnothing h6$		
15.60							
15.70							
5/8							
16.00	92.5	166.5	50.0	19.05	3/4	H85541/64	
16.10							
16.20							
41/64							
16.50							
16.60							
21/32							
16.70							
17.00	97.5	171.5	50.0	19.05	3/4	H85511/16	H860N2
43/64							
17.10							
17.20							
11/16							
17.50							
17.60							
17.70							
45/64							
18.00	103.5	176.5	50.0	19.05	3/4	H85523/32	
18.10							
18.20							
23/32							
18.50							
18.60							
47/64							
18.70							
18.90							
19.00	108.5	191.5	56.0	25.40	1"	H85549/64	H860N3
3/4							
19.10							
19.20							
19.25							
49/64							
19.50							
19.60							
19.70							
25/32	114.5	196.5	56.0	25.40	1"	H85551/64	
20.00							
51/64							
20.50							
13/16							
21.00	119.5	196.5	56.0	25.40	1"	H85527/32	H861N3
53/64							
27/32							
21.50							
55/64							
22.00	125.1	201.1	56.0	25.40	1"	H85557/64	
7/8							
22.50							
57/64							
22.70							
23.00							
29/32	129.5	210.5	56.0	25.40	1"	H85559/64	H860N4
59/64							
23.50							
15/16							
24.00	135.2	220.2	60.0	25.40	1"	H85531/32	
61/64							
24.50							
31/32							

					 H855			
d ₁	l ₂	l ₁	l ₃	d ₂ Øh6	H855			
Øh7	mm	mm	mm	mm				
25.00						H860N5	H861N4	
63/64								
1"	140.0	225.0	60.0	32.00	H85525.0			
25.50								
25.65								
1.1/64								
26.00								
1.1/32	146.0	230.0	60.0	32.00	H85526.0			
26.50								
1.3/64								
1.1/16						H860N6	H861N5	
27.00								
1.5/64	151.0	235.0	60.0	32.00	H85527.0			
27.50								
1.3/32								
28.00								
1.7/64	157.0	240.0	60.0	32.00	H85528.0			
28.50								
1.1/8								
1.9/64								
29.00						H860N7	H861N6	
1.5/32	162.0	245.0	60.0	32.00	H85529.0			
29.50								
1.11/64								
30.00								
1.3/16	167.0	255.0	60.0	32.00	H85530.0			
30.50								
1.7/32								
31.00								
1.1/4	176.5	261.5	60.0	32.00	H85532.0			
32.00						H860N7	H861N6	
32.50								
1.19/64	186.5	271.5	60.0	32.00	H85533.5			
33.00								
33.50								
34.00								
1.11/32	196.5	291.5	70.0	40.00	H85535.0			
34.50								
1.3/8								
35.00								
36.00						H860N7	H861N6	
1.27/64	201.5	296.5	70.0	40.00	H85536.5			
36.50								
37.00								
1.15/32	211.5	306.5	70.0	40.00	H85538.0			
37.50								
38.00								
1.1/2								
38.50								
1/17/32	221.5	316.5	70.0	40.00	H85539.5			
39.00						H860N7	H861N6	
39.50								
1.9/16	226.5	325.6	70.0	40.00	H85541.0			
40.00								
41.00						H860N7	H861N6	
1.5/8	236.5	336.5	70.0	40.00	H85542.5			
42.00								

						 H855			
d ₁	l ₂	l ₁	l ₃	d ₂ Øh6	d ₂ Øh6 inch	H855			
Øh7	mm	mm	mm	mm	inch				
25.00							H860N5	H861N4	
63/64									
1"	140.0	225.0	60.0	31.75	1.1/4	H8551.1/64			
25.50									
25.65									
1.1/64									
26.00									
1.1/32	146.0	230.0	60.0	31.75	1.1/4	H8551.3/64			
26.50									
1.3/64									
1.1/16							H860N6	H861N5	
27.00									
1.5/64	151.0	235.0	60.0	31.75	1.1/4	H8551.3/32			
27.50									
1.3/32									
28.00									
1.7/64	157.0	240.0	60.0	31.75	1.1/4	H8551.1/8			
28.50									
1.1/8									
1.9/64									
29.00							H860N6	H861N5	
1.5/32	162.0	245.0	60.0	31.75	1.1/4	H8551.11/64			
29.50									
1.11/64									
30.00									
1.3/16	167.0	255.0	60.0	31.75	1.1/4	H8551.3/16			
30.50									

H858

HSS

DORMER

8XD

DIN 6535HE

H858

- 天龙钻头体 8 x D
- Corpos Hydra 8 x D
- Cuerpo Hydra 8 x D
- Hydra Body 8 x D



钻头刀体内包括 4 螺钉 H860 和 1 螺丝刀 H861





Quatro (4) parafusos H860 e uma (1) chave H861estão inclusos com o corpo da broca





Cuatro (4) tornillos H860 y un (1) destornillador H861 incluidos con cada cuerpo

Four (4) screws H860 and one (1) screwdriver H861 are included with a drill body



d_1 Øh7	l_2 mm	l_1 mm	l_3 mm	d_2 Øh6 mm	H858	H860N1	H861N1
13.50	124.5	191.5	48.0	16.00	H85814.0	H860N1	H861N1
13.60							
13.70							
13.80							
35/64							
14.00							
14.10							
14.20							
9/16							
14.50							
14.60	133.5	201.5	50.0	20.00	H85815.0	H860N1	H861N1
37/64							
14.70							
14.80							
15.00							
19/32							
15.10							
15.20							
39/64							
15.50							
15.60	141.5	211.5	50.0	20.00	H85816.0	H860N2	H861N2
15.70							
5/8							
16.00							
16.10							
16.20							
41/64							
16.50							
16.60							
21/32							
16.70	150.5	221.5	50.0	20.00	H85817.0	H860N2	H861N2
17.00							
43/64							
17.10							
17.20							
11/16							
17.50							
17.60							
17.70							
45/64							
18.00	158.5	226.5	50.0	20.00	H85818.0		
18.10							
18.20							
23/32							
18.50							
18.50							

																								
d_1	l_2	l_1	l_3	d_2	$\varnothing h6$	H858																		
$\varnothing h7$	mm	mm	mm	mm	mm																			
18.60	167.5	251.5	56.0	25.00	25.00	H85819.0	H860N3	H861N3																
47/64																								
18.70																								
18.90																								
19.00																								
3/4																								
19.10																								
19.20																								
19.25																								
49/64																								
19.50	175.5	264.5	56.0	25.00	25.00	H85820.0	H860N3	H861N3																
19.60																								
19.70																								
25/32																								
20.00																								
51/64																								
20.50																								
13/16									184.5	266.5	56.0	25.00	25.00	H85821.0	H860N3	H861N3								
21.00																								
53/64																								
27/32																								
21.50																								
55/64	192.1	271.1	56.0	25.00	25.00	H85822.0	H860N4	H861N3																
22.00																								
7/8																								
22.50																								
57/64																								
22.70																								
23.00									200.5	280.5	56.0	25.00	25.00	H85823.0	H860N4	H861N3								
29/32																								
59/64																								
23.50																								
15/16	208.2	295.2	60.0	32.00	32.00	H85824.0	H860N4	H861N3																
24.00																								
61/64																								
24.50																								
31/32																	217.0	300.0	60.0	32.00	32.00	H85825.0	H860N5	H861N4
25.00																								
63/64																								
1"																								
25.50																								
25.65																								
1.1/64	225.0	310.0	60.0	32.00	32.00	H85826.0	H860N5	H861N4																
26.00																								
1.1/32																								
26.50																								
1.3/64									234.0	320.0	60.0	32.00	32.00	H85827.0	H860N5	H861N4								
1.1/16																								
27.00																								
1.5/64																								
27.50																								
1.3/32																								

 d_1	l_2	l_1	l_3	d_2 $\varnothing h6$ mm	 H858				
$\varnothing h7$	mm	mm	mm						
28.00 1.7/64 28.50 1.1/8	242.0	325.0	60.0	32.00	H85828.0	H860N6	H861N5		
1.9/64 29.00 1.5/32 29.50 1.11/64	251.0	335.0	60.0	32.00	H85829.0				
30.00 1.3/16 30.50	259.0	345.0	60.0	32.00	H85830.0				
1.7/32 31.00 1.1/4 32.00	271.5	356.5	60.0	32.00	H85832.0				
32.50 1.19/64 33.00 33.50	286.5	371.5	60.0	32.00	H85833.5				
34.00 1.11/32 34.50 1.3/8 35.00	301.5	396.5	70.0	40.00	H85835.0			H860N7	H861N6
36.00 1.27/64 36.50	311.5	406.5	70.0	40.00	H85836.5				
37.00 1.15/32 37.50 38.00	326.5	421.5	70.0	40.00	H85838.0				
1.1/2 38.50 1/17/32 39.00 39.50	336.5	431.5	70.0	40.00	H85839.5				
1.9/16 40.00 41.00	351.5	451.5	70.0	40.00	H85841.0				
1.5/8 42.00	361.5	461.5	70.0	40.00	H85842.5				



- R122**
- 定心钻 短 - 120°
 - Broca de Pontear - 120°
 - Broca corta para centrados - 120°
 - Short Spotting Drill - 120°
- 不大于10.0 mm 为 4 后面钻尖
Ponta de Quatro Faces até 10,0 mm
Punta de cuatro caras hasta 10,0mm
Four Facet Point upto 10,0mm
- R123**
- 定心钻 短 - 90°
 - Broca de Pontear - 90°
 - Broca corta para centrados - 90°
 - Short Spotting Drill - 90°
- 不大于10.0 mm 为 4 后面钻尖
Ponta de Quatro Facetas até 10mm
Punta de cuatro caras hasta 10,0mm
Four Facet Point upto 10,0mm

R122; R123	1.1	1.2	1.3	1.4	1.5	1.6	1.7	1.8	2.1	2.2	3.1	3.2	3.3	3.4	4.1	4.2	4.3	5.1
	5.2	5.3	6.1	6.2	6.3	6.4	7.1	7.2	7.3	7.4	8.1	8.2						

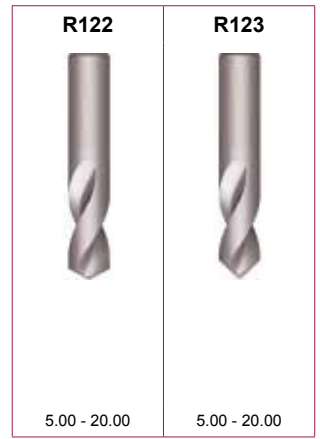
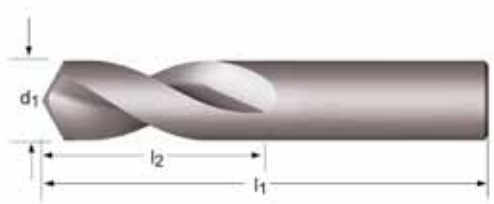

d_1 $\varnothing h_6$ mm	d_1 decimal Inch	l_2 mm	l_1 mm	R122	R123
5.00	0.1969	16	62	R1225.0	R1235.0
6.00	0.2362	17	66	R1226.0	R1236.0
8.00	0.3150	22	79	R1228.0	R1238.0
10.00	0.3937	26	89	R12210.0	R12310.0
12.00	0.4724	30	102	R12212.0	R12312.0
16.00	0.6299	34	115	R12216.0	R12316.0
20.00	0.7874	40	131	R12220.0	R12320.0

R120



R120

- 短型钻头
- Broca Serie Curta
- Broca extra corta
- Stub Drill

R120	▪	4.1	5.1	6.1	7.1	8.1	8.2															
	•	1.1	1.2	1.3	1.4	1.5	1.6	1.7	1.8	3.1	3.2	3.3	3.4	4.2	4.3	5.2	5.3	6.2	6.3	6.4	7.2	
		7.3	7.4																			

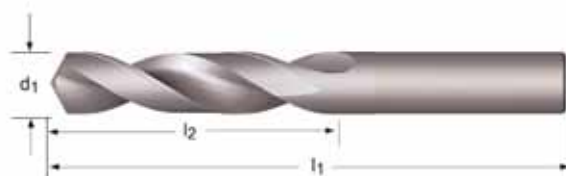

d_1 $\varnothing h_7$ mm	d_1 decimal Inch	l_2 mm	l_1 mm	R120
1.00	0.0394	6	26	R1201.0
1.10	0.0433	7	28	R1201.1
1.20	0.0472	8	30	R1201.2
1.30	0.0512	8	30	R1201.3
1.40	0.0551	9	32	R1201.4
1.50	0.0591	9	32	R1201.5
1.60	0.0630	10	34	R1201.6
1.70	0.0669	10	34	R1201.7
1.80	0.0709	11	36	R1201.8
1.90	0.0748	11	36	R1201.9
2.00	0.0787	12	38	R1202.0
2.10	0.0827	12	38	R1202.1
2.20	0.0866	13	40	R1202.2
2.30	0.0906	13	40	R1202.3
2.40	0.0945	14	43	R1202.4
2.50	0.0984	14	43	R1202.5
2.60	0.1024	14	43	R1202.6
2.70	0.1063	16	46	R1202.7
2.80	0.1102	16	46	R1202.8
2.90	0.1142	16	46	R1202.9
3.00	0.1181	16	46	R1203.0
3.10	0.1220	18	49	R1203.1
3.20	0.1260	18	49	R1203.2
3.30	0.1299	18	49	R1203.3
3.40	0.1339	20	52	R1203.4
3.50	0.1378	20	52	R1203.5
3.60	0.1417	20	52	R1203.6
3.70	0.1457	20	52	R1203.7
3.80	0.1496	22	55	R1203.8
3.90	0.1535	22	55	R1203.9
4.00	0.1575	22	55	R1204.0
4.10	0.1614	22	55	R1204.1
4.20	0.1654	22	55	R1204.2
4.30	0.1693	24	58	R1204.3
4.40	0.1732	24	58	R1204.4
4.50	0.1772	24	58	R1204.5

d_1 $\varnothing h_7$ mm	d_1 decimal Inch	l_2 mm	l_1 mm	R120
4.60	0.1811	24	58	R1204.6
4.70	0.1850	24	58	R1204.7
4.80	0.1890	26	62	R1204.8
4.90	0.1929	26	62	R1204.9
5.00	0.1969	26	62	R1205.0
5.10	0.2008	26	62	R1205.1
5.20	0.2047	26	62	R1205.2
5.30	0.2087	26	62	R1205.3
5.40	0.2126	28	66	R1205.4
5.50	0.2165	28	66	R1205.5
5.60	0.2205	28	66	R1205.6
5.70	0.2244	28	66	R1205.7
5.80	0.2283	28	66	R1205.8
5.90	0.2323	28	66	R1205.9
6.00	0.2362	28	66	R1206.0
6.10	0.2402	31	70	R1206.1
6.20	0.2441	31	70	R1206.2
6.30	0.2480	31	70	R1206.3
6.40	0.2520	31	70	R1206.4
6.50	0.2559	31	70	R1206.5
6.60	0.2598	31	70	R1206.6
6.70	0.2638	31	70	R1206.7
6.80	0.2677	34	74	R1206.8
6.90	0.2717	34	74	R1206.9
7.00	0.2756	34	74	R1207.0
7.10	0.2795	34	74	R1207.1
7.20	0.2835	34	74	R1207.2
7.30	0.2874	34	74	R1207.3
7.40	0.2913	34	74	R1207.4
7.50	0.2953	34	74	R1207.5
7.60	0.2992	37	79	R1207.6
7.70	0.3031	37	79	R1207.7
7.80	0.3071	37	79	R1207.8
7.90	0.3110	37	79	R1207.9
8.00	0.3150	37	79	R1208.0
8.10	0.3189	37	79	R1208.1
8.20	0.3228	37	79	R1208.2
8.30	0.3268	37	79	R1208.3
8.40	0.3307	37	79	R1208.4
8.50	0.3346	37	79	R1208.5
8.60	0.3386	40	84	R1208.6
8.70	0.3425	40	84	R1208.7
8.80	0.3465	40	84	R1208.8
8.90	0.3504	40	84	R1208.9
9.00	0.3543	40	84	R1209.0
9.10	0.3583	40	84	R1209.1
9.20	0.3622	40	84	R1209.2
9.30	0.3661	40	84	R1209.3
9.40	0.3701	40	84	R1209.4
9.50	0.3740	40	84	R1209.5
9.60	0.3780	43	89	R1209.6
9.70	0.3819	43	89	R1209.7
9.80	0.3858	43	89	R1209.8
9.90	0.3898	43	89	R1209.9
10.00	0.3937	43	89	R12010.0
10.20	0.4016	43	89	R12010.2
10.50	0.4134	43	89	R12010.5
11.00	0.4331	47	95	R12011.0
11.50	0.4528	47	95	R12011.5
12.00	0.4724	51	102	R12012.0

R520



- CDX 短型钻头
- Broca CDX Serie Extra Curta
- Broca CDX , serie extra corta
- CDX Stub Drill

R520

R520	▪	1.1	1.2	1.3	1.4	1.5	1.6	3.1	3.2	3.3	3.4	5.1	7.1	7.2	7.3	7.4	8.1	8.2
	•	1.7	1.8	2.1	4.1	4.2	4.3											

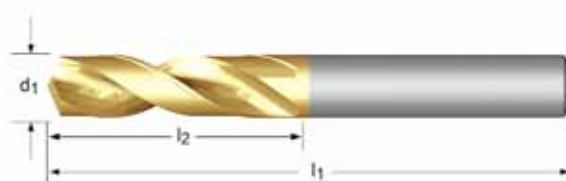

d_1 $\varnothing h_7$ Inch	d_1 $\varnothing h_7$ mm	d_1 decimal Inch	l_2 mm	l_1 mm	R520
	3.00	0.1181	16	46	R5203.0
	3.10	0.1220	18	49	R5203.1
1/8	3.18	0.1252	18	49	R5201/8
	3.20	0.1260	18	49	R5203.2
	3.30	0.1299	18	49	R5203.3
	3.40	0.1339	20	52	R5203.4
	3.50	0.1378	20	52	R5203.5
9/64	3.57	0.1406	20	52	R5209/64
	3.60	0.1417	20	52	R5203.6
	3.70	0.1457	20	52	R5203.7
	3.80	0.1496	22	55	R5203.8
	3.90	0.1535	22	55	R5203.9
5/32	3.97	0.1563	22	55	R5205/32
	4.00	0.1575	22	55	R5204.0
	4.10	0.1614	22	55	R5204.1
	4.20	0.1654	22	55	R5204.2
	4.30	0.1693	24	58	R5204.3
11/64	4.37	0.1720	24	58	R52011/64
	4.40	0.1732	24	58	R5204.4
	4.50	0.1772	24	58	R5204.5
	4.60	0.1811	24	58	R5204.6
	4.70	0.1850	24	58	R5204.7
3/16	4.76	0.1874	26	62	R5203/16
	4.80	0.1890	26	62	R5204.8
	4.90	0.1929	26	62	R5204.9
	5.00	0.1969	26	62	R5205.0
	5.10	0.2008	26	62	R5205.1
13/64	5.16	0.2031	26	62	R52013/64
	5.20	0.2047	26	62	R5205.2
	5.30	0.2087	26	62	R5205.3
	5.40	0.2126	28	66	R5205.4
	5.50	0.2165	28	66	R5205.5
7/32	5.56	0.2189	28	66	R5207/32
	5.60	0.2205	28	66	R5205.6
	5.70	0.2244	28	66	R5205.7
	5.80	0.2283	28	66	R5205.8
	5.90	0.2323	28	66	R5205.9
15/64	5.95	0.2343	28	66	R52015/64

d_1 \varnothing_{h_7} Inch	d_1 \varnothing_{h_7} mm	d_1 decimal Inch	l_2 mm	l_1 mm	R520
	6.00	0.2362	28	66	R5206.0
	6.10	0.2402	31	70	R5206.1
	6.20	0.2441	31	70	R5206.2
	6.30	0.2480	31	70	R5206.3
1/4	6.35	0.2500	31	70	R5201/4
	6.40	0.2520	31	70	R5206.4
	6.50	0.2559	31	70	R5206.5
	6.60	0.2598	31	70	R5206.6
	6.70	0.2638	31	70	R5206.7
17/64	6.75	0.2657	34	74	R52017/64
	6.80	0.2677	34	74	R5206.8
	6.90	0.2717	34	74	R5206.9
	7.00	0.2756	34	74	R5207.0
	7.10	0.2795	34	74	R5207.1
9/32	7.14	0.2811	34	74	R5209/32
	7.20	0.2835	34	74	R5207.2
	7.30	0.2874	34	74	R5207.3
	7.40	0.2913	34	74	R5207.4
	7.50	0.2953	34	74	R5207.5
19/64	7.54	0.2969	37	79	R52019/64
	7.60	0.2992	37	79	R5207.6
	7.70	0.3031	37	79	R5207.7
	7.80	0.3071	37	79	R5207.8
	7.90	0.3110	37	79	R5207.9
5/16	7.94	0.3126	37	79	R5205/16
	8.00	0.3150	37	79	R5208.0
	8.10	0.3189	37	79	R5208.1
	8.20	0.3228	37	79	R5208.2
	8.30	0.3268	37	79	R5208.3
21/64	8.33	0.3280	37	79	R52021/64
	8.40	0.3307	37	79	R5208.4
	8.50	0.3346	37	79	R5208.5
	8.60	0.3386	40	84	R5208.6
	8.70	0.3425	40	84	R5208.7
11/32	8.73	0.3437	40	84	R52011/32
	8.80	0.3465	40	84	R5208.8
	8.90	0.3504	40	84	R5208.9
	9.00	0.3543	40	84	R5209.0
	9.10	0.3583	40	84	R5209.1
23/64	9.13	0.3594	40	84	R52023/64
	9.20	0.3622	40	84	R5209.2
	9.30	0.3661	40	84	R5209.3
	9.40	0.3701	40	84	R5209.4
	9.50	0.3740	40	84	R5209.5
3/8	9.52	0.3748	43	89	R5203/8
	9.60	0.3780	43	89	R5209.6
	9.70	0.3819	43	89	R5209.7
	9.80	0.3858	43	89	R5209.8
	9.90	0.3898	43	89	R5209.9
25/64	9.92	0.3906	43	89	R52025/64
	10.00	0.3937	43	89	R52010.0
	10.10	0.3976	43	89	R52010.1
	10.20	0.4016	43	89	R52010.2
	10.30	0.4055	43	89	R52010.3
13/32	10.32	0.4063	43	89	R52013/32
	10.40	0.4094	43	89	R52010.4
	10.50	0.4134	43	89	R52010.5
27/64	10.72	0.4220	47	95	R52027/64
	11.00	0.4331	47	95	R52011.0
7/16	11.11	0.4374	47	95	R5207/16
	11.20	0.4409	47	95	R52011.2
	11.50	0.4528	47	95	R52011.5
29/64	11.51	0.4531	47	95	R52029/64
15/32	11.91	0.4689	51	102	R52015/32
	12.00	0.4724	51	102	R52012.0
31/64	12.30	0.4843	51	102	R52031/64
	12.50	0.4921	51	102	R52012.5
1/2	12.70	0.5000	51	102	R5201/2

d_1 $\varnothing h_7$ Inch	d_1 $\varnothing h_7$ mm	d_1 decimal Inch	l_2 mm	l_1 mm	R520
	13.00	0.5118	51	102	R52013.0
	13.50	0.5315	54	107	R52013.5
	14.00	0.5512	54	107	R52014.0
	14.20	0.5591	56	111	R52014.2
	14.25	0.5610	56	111	R52014.25
9/16	14.29	0.5626	56	111	R5209/16
	14.50	0.5709	56	111	R52014.5
	15.00	0.5906	56	111	R52015.0
	15.10	0.5945	58	115	R52015.1
5/8	15.88	0.6252	58	115	R5205/8
	16.00	0.6299	58	115	R52016.0
	16.50	0.6496	60	119	R52016.5



- MP-X 短钻 3XD
- Broca MP-X Serie Curta 3XD
- Broca corta - MP-X 3XD
- MP-X Short Drill 3XD

R458

- MP-X 短形内冷钻头 3XD
- Broca MP-X Serie Curta com refrigeração interna 3XD
- Broca corta - MP-X - refrigeración interna 3XD
- MP-X Short Drill Oil Feed 3XD

R457

R458	▪	1.1	1.2	1.3	1.4	1.5	1.6	1.7	1.8	2.1	2.2	2.3	3.1	3.2	3.3	3.4	6.1	6.2	6.3	7.1	7.2
		7.3	7.4																		
	•	2.4	4.1	4.2	4.3	6.4															
R457	▪	1.1	1.2	1.3	1.4	1.5	1.6	1.7	1.8	2.1	2.2	2.3	3.1	3.2	3.3	3.4	4.1	4.2	4.3	6.1	6.2
		6.3	6.4	7.1	7.2	7.3	7.4														

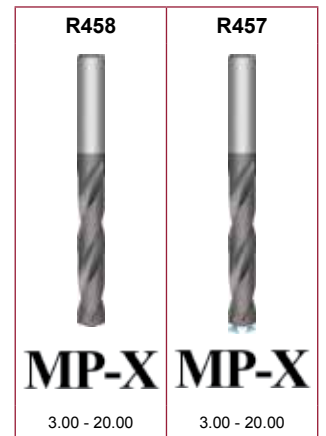

d_1 Ø Inch/Nr.	d_1 Ø _{m7} mm	d_1 decimal Inch	l_2 mm	l_1 mm	l_3 mm	d_2 Ø _{h6} mm	R458	R457
	3.00	0.1181	20	62	36	6	R4583.0	R4573.0
	3.10	0.1220	20	62	36	6	R4583.1	R4573.1
1/8	3.18	0.1252	20	62	36	6	R4581/8	R4571/8
	3.20	0.1260	20	62	36	6	R4583.2	R4573.2
30	3.26	0.1283	20	62	36	6	R458N30	R457N30
	3.30	0.1299	20	62	36	6	R4583.3	R4573.3
	3.40	0.1339	20	62	36	6	R4583.4	R4573.4
29	3.45	0.1358	20	62	36	6	R458N29	R457N29
	3.50	0.1378	20	62	36	6	R4583.5	R4573.5
28	3.57	0.1406	20	62	36	6	R458N28	R457N28
9/64	3.57	0.1406	20	62	36	6	R4589/64	R4579/64
	3.60	0.1417	20	62	36	6	R4583.6	R4573.6
27	3.66	0.1441	20	62	36	6	R458N27	R457N27
	3.70	0.1457	20	62	36	6	R4583.7	R4573.7
	3.73	0.1469	24	66	36	6	R4583.73	
26	3.73	0.1469	24	66	36	6	R458N26	R457N26
25	3.80	0.1496	24	66	36	6	R4583.8	R4573.8
24	3.86	0.1520	24	66	36	6	R458N24	R457N24
	3.90	0.1535	24	66	36	6	R4583.9	R4573.9
23	3.91	0.1539	24	66	36	6	R458N23	R457N23
5/32	3.97	0.1563	24	66	36	6	R4585/32	R4575/32
22	3.99	0.1571	24	66	36	6	R458N22	R457N22
	4.00	0.1575	24	66	36	6	R4584.0	R4574.0
21	4.04	0.1591	24	66	36	6	R458N21	R457N21

d ₁ Ø Inch/Nr.	d ₁ Ø _{m7} mm	d ₁ decimal Inch	l ₂ mm	l ₁ mm	l ₃ mm	d ₂ Øh ₆ mm	R458	R457
	4.05	0.1594	24	66	36	6		R4574.05
20	4.09	0.1610	24	66	36	6	R458N20	R457N20
	4.10	0.1614	24	66	36	6	R4584.1	R4574.1
	4.20	0.1654	24	66	36	6	R4584.2	R4574.2
19	4.22	0.1661	24	66	36	6	R458N19	R457N19
	4.30	0.1693	24	66	36	6	R4584.3	R4574.3
18	4.31	0.1697	24	66	36	6	R458N18	R457N18
11/64	4.37	0.1720	24	66	36	6	R45811/64	R45711/64
17	4.39	0.1728	24	66	36	6	R458N17	R457N17
	4.40	0.1732	24	66	36	6	R4584.4	R4574.4
	4.50	0.1772	24	66	36	6	R4584.5	R4574.5
16	4.50	0.1772	24	66	36	6	R458N16	R457N16
15	4.57	0.1799	24	66	36	6	R458N15	R457N15
	4.60	0.1811	24	66	36	6	R4584.6	R4574.6
	4.62	0.1819	24	66	36	6	R458N14	R457N14
13	4.70	0.1850	24	66	36	6	R4584.7	R4574.7
3/16	4.76	0.1874	28	66	36	6	R4583/16	R4573/16
	4.80	0.1890	28	66	36	6	R4584.8	R4574.8
12	4.80	0.1890	28	66	36	6	R458N12	R457N12
11	4.85	0.1909	28	66	36	6	R458N11	R457N11
	4.90	0.1929	28	66	36	6	R4584.9	R4574.9
10	4.92	0.1937	28	66	36	6	R458N10	R457N10
9	4.98	0.1961	28	66	36	6	R458N9	R457N9
	5.00	0.1969	28	66	36	6	R4585.0	R4575.0
	5.05	0.1988	28	66	36	6		R4575.05
8	5.06	0.1992	28	66	36	6	R458N8	R457N8
	5.10	0.2008	28	66	36	6	R4585.1	R4575.1
7	5.11	0.2012	28	66	36	6	R458N7	R457N7
13/64	5.16	0.2031	28	66	36	6	R45813/64	R45713/64
6	5.18	0.2039	28	66	36	6	R458N6	R457N6
	5.20	0.2047	28	66	36	6	R4585.2	R4575.2
5	5.22	0.2055	28	66	36	6	R458N5	R457N5
4	5.31	0.2091	28	66	36	6	R458N4	R457N4
3	5.41	0.2130	28	66	36	6	R458N3	R457N3
	5.50	0.2165	28	66	36	6	R4585.5	R4575.5
7/32	5.56	0.2189	28	66	36	6	R4587/32	R4577/32
	5.60	0.2205	28	66	36	6	R4585.6	R4575.6
2	5.61	0.2209	28	66	36	6	R458N2	R457N2
	5.70	0.2244	28	66	36	6	R4585.7	R4575.7
1	5.79	0.2280	28	66	36	6	R458N1	R457N1
	5.80	0.2283	28	66	36	6	R4585.8	R4575.8
15/64	5.95	0.2343	28	66	36	6	R45815/64	R45715/64
	6.00	0.2362	28	66	36	6	R4586.0	R4576.0
	6.05	0.2382	34	79	36	8		R4576.05
	6.10	0.2402	34	79	36	8	R4586.1	R4576.1
	6.20	0.2441	34	79	36	8	R4586.2	R4576.2
	6.30	0.2480	34	79	36	8	R4586.3	R4576.3
1/4	6.35	0.2500	34	79	36	8	R4581/4	R4571/4
	6.40	0.2520	34	79	36	8	R4586.4	R4576.4
	6.50	0.2559	34	79	36	8	R4586.5	R4576.5
	6.60	0.2598	34	79	36	8	R4586.6	R4576.6
	6.70	0.2638	34	79	36	8	R4586.7	R4576.7
17/64	6.75	0.2657	34	79	36	8	R45817/64	R45717/64
	6.80	0.2677	34	79	36	8	R4586.8	R4576.8
	6.90	0.2717	34	79	36	8	R4586.9	R4576.9
	7.00	0.2756	34	79	36	8	R4587.0	R4577.0
	7.10	0.2795	41	79	36	8	R4587.1	R4577.1
9/32	7.14	0.2811	41	79	36	8	R4589/32	R4579/32
	7.30	0.2874	41	79	36	8	R4587.3	R4577.3
	7.40	0.2913	41	79	36	8	R4587.4	R4577.4
	7.50	0.2953	41	79	36	8	R4587.5	R4577.5
19/64	7.54	0.2969	41	79	36	8	R45819/64	R45719/64
	7.60	0.2992	41	79	36	8	R4587.6	R4577.6
	7.70	0.3031	41	79	36	8	R4587.7	R4577.7
	7.80	0.3071	41	79	36	8	R4587.8	R4577.8
	7.90	0.3110	41	79	36	8	R4587.9	R4577.9
5/16	7.94	0.3126	41	79	36	8	R4585/16	R4575/16
	8.00	0.3150	41	79	36	8	R4588.0	R4578.0
	8.05	0.3169	47	89	40	10		R4578.05
	8.10	0.3189	47	89	40	10	R4588.1	R4578.1

d_1 Ø Inch/Nr.	d_1 Ø m_7 mm	d_1 decimal Inch	l_2 mm	l_1 mm	l_3 mm	d_2 Ø h_8 mm	R458	R457	
21/64	8.20	0.3228	47	89	40	10	R4588.2	R4578.2	
	8.33	0.3280	47	89	40	10	R45821/64	R45721/64	
	8.40	0.3307	47	89	40	10	R4588.4	R4578.4	
	8.50	0.3346	47	89	40	10	R4588.5	R4578.5	
	8.60	0.3386	47	89	40	10	R4588.6	R4578.6	
11/32	8.70	0.3425	47	89	40	10	R4588.7	R4578.7	
	8.73	0.3437	47	89	40	10	R45811/32	R45711/32	
	8.80	0.3465	47	89	40	10	R4588.8	R4578.8	
	8.90	0.3504	47	89	40	10		R4578.9	
	9.00	0.3543	47	89	40	10	R4589.0	R4579.0	
23/64	9.10	0.3583	47	89	40	10	R4589.1	R4579.1	
	9.13	0.3594	47	89	40	10	R45823/64	R45723/64	
	9.30	0.3661	47	89	40	10	R4589.3	R4579.3	
	9.40	0.3701	47	89	40	10	R4589.4	R4579.4	
	9.50	0.3740	47	89	40	10	R4589.5	R4579.5	
3/8	9.52	0.3748	47	89	40	10	R4583/8	R4573/8	
	9.60	0.3780	47	89	40	10	R4589.6	R4579.6	
	9.70	0.3819	47	89	40	10	R4589.7	R4579.7	
	9.80	0.3858	47	89	40	10	R4589.8	R4579.8	
	9.90	0.3898	47	89	40	10	R4589.9	R4579.9	
25/64	9.92	0.3906	47	89	40	10	R45825/64	R45725/64	
	10.00	0.3937	47	89	40	10	R45810.0	R45710.0	
	10.05	0.3957	55	102	45	12		R45710.05	
	10.10	0.3976	55	102	45	12	R45810.1	R45710.1	
	10.20	0.4016	55	102	45	12	R45810.2	R45710.2	
13/32	10.30	0.4055	55	102	45	12	R45810.3	R45710.3	
	10.32	0.4063	55	102	45	12	R45813/32	R45713/32	
	10.40	0.4094	55	102	45	12	R45810.4	R45710.4	
	10.50	0.4134	55	102	45	12	R45810.5	R45710.5	
	10.60	0.4173	55	102	45	12	R45810.6	R45710.6	
27/64	10.72	0.4220	55	102	45	12	R45827/64	R45727/64	
	10.80	0.4252	55	102	45	12	R45810.8		
	11.00	0.4331	55	102	45	12	R45811.0	R45711.0	
	7/16	11.11	0.4374	55	102	45	12	R4587/16	R4577/16
	11.20	0.4409	55	102	45	12	R45811.2	R45711.2	
29/64	11.40	0.4488	55	102	45	12	R45811.4	R45711.4	
	11.50	0.4528	55	102	45	12	R45811.5	R45711.5	
	11.51	0.4531	55	102	45	12	R45829/64	R45729/64	
	11.60	0.4567	55	102	45	12	R45811.6	R45711.6	
	11.80	0.4646	55	102	45	12	R45811.8	R45711.8	
15/32	11.91	0.4689	55	102	45	12	R45815/32	R45715/32	
	12.00	0.4724	55	102	45	12	R45812.0	R45712.0	
	12.05	0.4744	60	107	45	14		R45712.05	
	12.10	0.4764	60	107	45	14	R45812.1	R45712.1	
	12.20	0.4803	60	107	45	14	R45812.2	R45712.2	
31/64	12.30	0.4843	60	107	45	14	R45831/64	R45731/64	
	12.50	0.4921	60	107	45	14	R45812.5	R45712.5	
	12.70	0.5000	60	107	45	14	R45812.7	R45712.7	
	1/2	12.70	0.5000	60	107	45	14	R4581/2	R4571/2
	12.80	0.5039	60	107	45	14	R45812.8	R45712.8	
33/64	13.00	0.5118	60	107	45	14	R45813.0	R45713.0	
	13.10	0.5157	60	107	45	14	R45833/64	R45733/64	
	17/32	13.49	0.5311	60	107	45	14	R45817/32	R45717/32
	13.50	0.5315	60	107	45	14	R45813.5	R45713.5	
	13.80	0.5433	60	107	45	14	R45813.8	R45713.8	
35/64	13.89	0.5469	60	107	45	14	R45835/64	R45735/64	
	14.00	0.5512	60	107	45	14	R45814.0	R45714.0	
	14.25	0.5610	65	115	48	16	R45814.25	R45714.25	
	9/16	14.29	0.5626	65	115	48	16	R4589/16	R4579/16
	14.50	0.5709	65	115	48	16	R45814.5	R45714.5	
37/64	14.68	0.5780	65	115	48	16	R45837/64	R45737/64	
	14.80	0.5827	65	115	48	16	R45814.8	R45714.8	
	15.00	0.5906	65	115	48	16	R45815.0	R45715.0	
	19/32	15.08	0.5937	65	115	48	16	R45819/32	R45719/32
	15.10	0.5945	65	115	48	16	R45815.1	R45715.1	
39/64	15.48	0.6094	65	115	48	16	R45839/64	R45739/64	
	15.50	0.6102	65	115	48	16	R45815.5	R45715.5	
	15.80	0.6220	65	115	48	16	R45815.8	R45715.8	
	5/8	15.88	0.6252	65	115	48	16	R4585/8	R4575/8
	16.00	0.6299	65	115	48	16	R45816.0	R45716.0	

d_1 Ø Inch/Nr.	d_1 Ø m_7 mm	d_1 decimal Inch	l_2 mm	l_1 mm	l_3 mm	d_2 Ø h_6 mm	R458	R457
41/64	16.27	0.6406	73	123	48	18	R45841/64	R45741/64
	16.50	0.6496	73	123	48	18	R45816.5	R45716.5
21/32	16.67	0.6563	73	123	48	18	R45821/32	R45721/32
	17.00	0.6693	73	123	48	18	R45817.0	R45717.0
43/64	17.07	0.6720	73	123	48	18	R45843/64	R45743/64
	17.46	0.6874	73	123	48	18	R45811/16	R45711/16
11/16	17.50	0.6890	73	123	48	18	R45817.5	R45717.5
	17.80	0.7008	73	123	48	18	R45817.8	
45/64	17.86	0.7031	73	123	48	18	R45845/64	R45745/64
	18.00	0.7087	73	123	48	18	R45818.0	R45718.0
23/32	18.26	0.7189	79	131	50	20	R45823/32	R45723/32
	18.50	0.7283	79	131	50	20	R45818.5	R45718.5
47/64	18.65	0.7343	79	131	50	20	R45847/64	R45747/64
	18.80	0.7402	79	131	50	20		R45718.8
3/4	19.00	0.7480	79	131	50	20	R45819.0	R45719.0
	19.05	0.7500	79	131	50	20	R4583/4	R4573/4
3/4	19.50	0.7677	79	131	50	20	R45819.5	R45719.5
	19.80	0.7795	79	131	50	20	R45819.8	R45719.8
	20.00	0.7874	79	131	50	20	R45820.0	R45720.0

R100



- 普通长度钻头
- Broca Serie Normal
- Broca , serie corta
- Jobber Drill

R100

R100	▪	6.2	6.3	8.1	8.2														
	•	1.1	1.2	1.3	1.4	1.5	1.6	1.7	1.8	3.1	3.2	3.3	3.4	7.1	7.2	7.3	7.4		



d_1 \varnothing_{h_7} mm	d_1 decimal Inch	l_2 mm	l_1 mm	R100
1.00	0.0394	12	34	R1001.0
1.10	0.0433	14	36	R1001.1
1.20	0.0472	16	38	R1001.2
1.30	0.0512	16	38	R1001.3
1.40	0.0551	18	40	R1001.4
1.50	0.0591	18	40	R1001.5
1.60	0.0630	20	43	R1001.6
1.70	0.0669	20	43	R1001.7
1.80	0.0709	22	46	R1001.8
1.90	0.0748	22	46	R1001.9
2.00	0.0787	24	49	R1002.0
2.10	0.0827	24	49	R1002.1
2.20	0.0866	27	53	R1002.2
2.30	0.0906	27	53	R1002.3
2.40	0.0945	30	57	R1002.4
2.50	0.0984	30	57	R1002.5
2.60	0.1024	30	57	R1002.6
2.70	0.1063	33	61	R1002.7
2.80	0.1102	33	61	R1002.8
2.90	0.1142	33	61	R1002.9
3.00	0.1181	33	61	R1003.0
3.10	0.1220	36	65	R1003.1
3.20	0.1260	36	65	R1003.2
3.30	0.1299	36	65	R1003.3
3.40	0.1339	39	70	R1003.4
3.50	0.1378	39	70	R1003.5
3.60	0.1417	39	70	R1003.6
3.70	0.1457	39	70	R1003.7
3.80	0.1496	43	75	R1003.8
3.90	0.1535	43	75	R1003.9
4.00	0.1575	43	75	R1004.0
4.10	0.1614	43	75	R1004.1
4.20	0.1654	43	75	R1004.2
4.30	0.1693	47	80	R1004.3
4.40	0.1732	47	80	R1004.4
4.50	0.1772	47	80	R1004.5
4.60	0.1811	47	80	R1004.6
4.70	0.1850	47	80	R1004.7

d_1 $\varnothing h_7$ mm	d_1 decimal Inch	l_2 mm	l_1 mm	R100
4.80	0.1890	52	86	R1004.8
4.90	0.1929	52	86	R1004.9
5.00	0.1969	52	86	R1005.0
5.10	0.2008	52	86	R1005.1
5.20	0.2047	52	86	R1005.2
5.30	0.2087	52	86	R1005.3
5.40	0.2126	57	93	R1005.4
5.50	0.2165	57	93	R1005.5
5.60	0.2205	57	93	R1005.6
5.70	0.2244	57	93	R1005.7
5.80	0.2283	57	93	R1005.8
5.90	0.2323	57	93	R1005.9
6.00	0.2362	57	93	R1006.0
6.10	0.2402	63	101	R1006.1
6.20	0.2441	63	101	R1006.2
6.30	0.2480	63	101	R1006.3
6.40	0.2520	63	101	R1006.4
6.50	0.2559	63	101	R1006.5
6.60	0.2598	63	101	R1006.6
6.70	0.2638	63	101	R1006.7
6.80	0.2677	69	109	R1006.8
6.90	0.2717	69	109	R1006.9
7.00	0.2756	69	109	R1007.0
7.10	0.2795	69	109	R1007.1
7.20	0.2835	69	109	R1007.2
7.30	0.2874	69	109	R1007.3
7.40	0.2913	69	109	R1007.4
7.50	0.2953	69	109	R1007.5
7.60	0.2992	75	117	R1007.6
7.70	0.3031	75	117	R1007.7
7.80	0.3071	75	117	R1007.8
7.90	0.3110	75	117	R1007.9
8.00	0.3150	75	117	R1008.0
8.10	0.3189	75	117	R1008.1
8.20	0.3228	75	117	R1008.2
8.30	0.3268	75	117	R1008.3
8.40	0.3307	75	117	R1008.4
8.50	0.3346	75	117	R1008.5
8.60	0.3386	81	125	R1008.6
8.70	0.3425	81	125	R1008.7
8.80	0.3465	81	125	R1008.8
8.90	0.3504	81	125	R1008.9
9.00	0.3543	81	125	R1009.0
9.10	0.3583	81	125	R1009.1
9.20	0.3622	81	125	R1009.2
9.30	0.3661	81	125	R1009.3
9.40	0.3701	81	125	R1009.4
9.50	0.3740	81	125	R1009.5
9.60	0.3780	87	133	R1009.6
9.70	0.3819	87	133	R1009.7
9.80	0.3858	87	133	R1009.8
9.90	0.3898	87	133	R1009.9
10.00	0.3937	87	133	R10010.0
10.20	0.4016	87	133	R10010.2
10.50	0.4134	87	133	R10010.5
11.00	0.4331	94	142	R10011.0
11.50	0.4528	94	142	R10011.5
12.00	0.4724	101	151	R10012.0
13.00	0.5118	101	151	R10013.0
14.00	0.5512	108	160	R10014.0

R510



- CDX 普通长度钻头
- Broca CDX Serie Normal
- Broca CDX , serie corta
- CDX Jobber Drill

R510

R510	▪	1.1	1.2	1.3	1.4	1.5	1.6	3.1	3.2	3.3	3.4	7.1	7.2	7.3	7.4	8.1	8.2
	•	1.7	1.8	2.1	4.1	5.1											



d_1 $\varnothing h_7$ Inch	d_1 $\varnothing h_7$ mm	d_1 decimal Inch	l_2 mm	l_1 mm	R510
	3.00	0.1181	33	61	R5103.0
1/8	3.18	0.1252	36	65	R5101/8
	3.20	0.1260	36	65	R5103.2
	3.30	0.1299	36	65	R5103.3
	3.40	0.1339	39	70	R5103.4
	3.50	0.1378	39	70	R5103.5
9/64	3.57	0.1406	39	70	R5109/64
	3.70	0.1457	39	70	R5103.7
	3.90	0.1535	43	75	R5103.9
5/32	3.97	0.1563	43	75	R5105/32
	4.00	0.1575	43	75	R5104.0
	4.10	0.1614	43	75	R5104.1
	4.20	0.1654	43	75	R5104.2
	4.30	0.1693	47	80	R5104.3
11/64	4.37	0.1720	47	80	R51011/64
	4.50	0.1772	47	80	R5104.5
	4.60	0.1811	47	80	R5104.6
	4.70	0.1850	47	80	R5104.7
3/16	4.76	0.1874	52	86	R5103/16
	4.90	0.1929	52	86	R5104.9
	5.00	0.1969	52	86	R5105.0
	5.10	0.2008	52	86	R5105.1
13/64	5.16	0.2031	52	86	R51013/64
	5.50	0.2165	57	93	R5105.5
7/32	5.56	0.2189	57	93	R5107/32
	5.60	0.2205	57	93	R5105.6
	5.70	0.2244	57	93	R5105.7
	6.00	0.2362	57	93	R5106.0
15/64	5.95	0.2343	57	93	R51015/64
1/4	6.35	0.2500	63	101	R5101/4
	6.50	0.2559	63	101	R5106.5
	6.60	0.2598	63	101	R5106.6
17/64	6.75	0.2657	69	109	R51017/64
	6.80	0.2677	69	109	R5106.8
	6.90	0.2717	69	109	R5106.9
	7.00	0.2756	69	109	R5107.0

d_1 $\varnothing h_7$ Inch	d_1 $\varnothing h_7$ mm	d_1 decimal Inch	l_2 mm	l_1 mm	R510
9/32	7.14	0.2811	69	109	R5109/32
	7.30	0.2874	69	109	R5107.3
	7.40	0.2913	69	109	R5107.4
	7.50	0.2953	69	109	R5107.5
19/64	7.54	0.2969	75	117	R51019/64
	7.80	0.3071	75	117	R5107.8
	7.90	0.3110	75	117	R5107.9
5/16	7.94	0.3126	75	117	R5105/16
	8.00	0.3150	75	117	R5108.0
21/64	8.33	0.3280	75	117	R51021/64
	8.50	0.3346	75	117	R5108.5
	8.70	0.3425	81	125	R5108.7
11/32	8.73	0.3437	81	125	R51011/32
	8.80	0.3465	81	125	R5108.8
	9.00	0.3543	81	125	R5109.0
23/64	9.13	0.3594	81	125	R51023/64
	9.20	0.3622	81	125	R5109.2
	9.30	0.3661	81	125	R5109.3
	9.40	0.3701	81	125	R5109.4
	9.50	0.3740	81	125	R5109.5
3/8	9.52	0.3748	87	133	R5103/8
	9.90	0.3898	87	133	R5109.9
25/64	9.92	0.3906	87	133	R51025/64
	10.00	0.3937	87	133	R51010.0
	10.20	0.4016	87	133	R51010.2
	10.30	0.4055	87	133	R51010.3
13/32	10.32	0.4063	87	133	R51013/32
	10.40	0.4094	87	133	R51010.4
	10.50	0.4134	87	133	R51010.5
27/64	10.72	0.4220	94	142	R51027/64
	10.80	0.4252	94	142	R51010.8
	11.00	0.4331	94	142	R51011.0
7/16	11.11	0.4374	94	142	R5107/16
	11.20	0.4409	94	142	R51011.2
	11.50	0.4528	94	142	R51011.5
29/64	11.51	0.4531	94	142	R51029/64
15/32	11.91	0.4689	101	151	R51015/32
	12.00	0.4724	101	151	R51012.0
31/64	12.30	0.4843	101	151	R51031/64
1/2	12.70	0.5000	101	151	R5101/2
	13.00	0.5118	101	151	R51013.0
	14.00	0.5512	108	160	R51014.0
	14.25	0.5610	114	169	R51014.25



- MP-X 钻头 5XD
- Broca MP-X Serie Longa 5XD
- Broca larga - MP-X 5XD
- MP-X Long Drill 5XD

R454

- MP-X 内冷钻头 5XD
- Broca MP-X Serie Longa com refrigeração interna 5XD
- Broca larga - MP-X - refrigeración interna 5XD
- MP-X Long Drill Oil Feed 5XD

R453

R454	▪	1.1	1.2	1.3	1.4	1.5	1.6	1.7	1.8	2.1	2.2	2.3	3.1	3.2	3.3	3.4	6.1	6.2	6.3	7.1	7.2
		7.3	7.4																		
	•	2.4	4.1	4.2	4.3	6.4															
R453	▪	1.1	1.2	1.3	1.4	1.5	1.6	1.7	1.8	2.1	2.2	3.1	3.2	3.3	3.4	4.1	4.2	4.3	6.1	6.2	6.3
		6.4	7.1	7.2	7.3	7.4															
	•	2.3	2.4																		

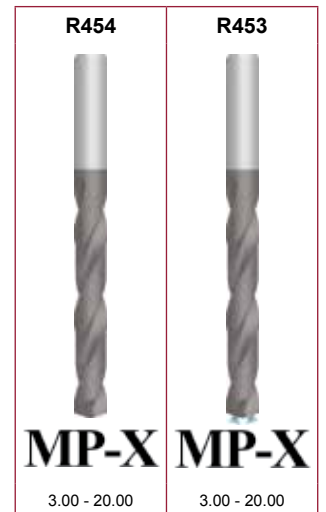

d ₁ Ø Inch	d ₁ Øm ₇ mm	d ₁ decimal Inch	l ₂ mm	l ₁ mm	l ₃ mm	d ₂ Øh ₈ mm	R454	R453
1/8	3.00	0.1181	28	66	36	6	R4543.0	R4533.0
	3.10	0.1220	28	66	36	6	R4543.1	R4533.1
	3.18	0.1252	28	66	36	6	R4541/8	R4531/8
	3.20	0.1260	28	66	36	6	R4543.2	R4533.2
	3.30	0.1299	28	66	36	6	R4543.3	R4533.3
	3.40	0.1339	28	66	36	6	R4543.4	R4533.4
9/64	3.50	0.1378	28	66	36	6	R4543.5	R4533.5
	3.57	0.1406	28	66	36	6	R4549/64	R4539/64
	3.60	0.1417	28	66	36	6	R4543.6	R4533.6
	3.70	0.1457	28	66	36	6	R4543.7	R4533.7
	3.80	0.1496	36	74	36	6	R4543.8	R4533.8
	3.90	0.1535	36	74	36	6	R4543.9	R4533.9
5/32	3.97	0.1563	36	74	36	6	R4545/32	R4535/32
	4.00	0.1575	36	74	36	6	R4544.0	R4534.0
	4.05	0.1594	36	74	36	6		R4534.05
	4.10	0.1614	36	74	36	6	R4544.1	R4534.1
	4.20	0.1654	36	74	36	6	R4544.2	R4534.2
	4.30	0.1693	36	74	36	6	R4544.3	R4534.3

d_1 \emptyset Inch	d_1 $\emptyset m_7$ mm	d_1 decimal Inch	l_2 mm	l_1 mm	l_3 mm	d_2 $\emptyset h_6$ mm	R454	R453
11/64	4.37	0.1720	36	74	36	6	R45411/64	R45311/64
	4.40	0.1732	36	74	36	6	R4544.4	R4534.4
	4.50	0.1772	36	74	36	6	R4544.5	R4534.5
	4.60	0.1811	36	74	36	6	R4544.6	R4534.6
3/16	4.70	0.1850	36	74	36	6	R4544.7	R4534.7
	4.76	0.1874	44	82	36	6	R4543/16	R4533/16
	4.80	0.1890	44	82	36	6	R4544.8	R4534.8
	4.90	0.1929	44	82	36	6	R4544.9	R4534.9
	5.00	0.1969	44	82	36	6	R4545.0	R4535.0
13/64	5.05	0.1988	44	82	36	6		R4535.05
	5.10	0.2008	44	82	36	6	R4545.1	R4535.1
	5.16	0.2031	44	82	36	6	R45413/64	R45313/64
	5.20	0.2047	44	82	36	6	R4545.2	R4535.2
7/32	5.50	0.2165	44	82	36	6	R4545.5	R4535.5
	5.56	0.2189	44	82	36	6	R4547/32	R4537/32
	5.60	0.2205	44	82	36	6	R4545.6	R4535.6
15/64	5.70	0.2244	44	82	36	6	R4545.7	R4535.7
	5.80	0.2283	44	82	36	6	R4545.8	R4535.8
	5.95	0.2343	44	82	36	6	R45415/64	R45315/64
	6.00	0.2362	44	82	36	6	R4546.0	R4536.0
	6.05	0.2382	53	91	36	8		R4536.05
1/4	6.10	0.2402	53	91	36	8	R4546.1	R4536.1
	6.20	0.2441	53	91	36	8	R4546.2	R4536.2
	6.30	0.2480	53	91	36	8	R4546.3	R4536.3
	6.35	0.2500	53	91	36	8	R4541/4	R4531/4
	6.40	0.2520	53	91	36	8	R4546.4	R4536.4
	6.50	0.2559	53	91	36	8	R4546.5	R4536.5
	6.60	0.2598	53	91	36	8	R4546.6	R4536.6
17/64	6.70	0.2638	53	91	36	8	R4546.7	R4536.7
	6.75	0.2657	53	91	36	8	R45417/64	R45317/64
	6.80	0.2677	53	91	36	8	R4546.8	R4536.8
	6.90	0.2717	53	91	36	8	R4546.9	R4536.9
	7.00	0.2756	53	91	36	8	R4547.0	R4537.0
9/32	7.10	0.2795	53	91	36	8	R4547.1	R4537.1
	7.14	0.2811	53	91	36	8	R4549/32	R4539/32
	7.30	0.2874	53	91	36	8	R4547.3	R4537.3
	7.40	0.2913	53	91	36	8	R4547.4	R4537.4
19/64	7.50	0.2953	53	91	36	8	R4547.5	R4537.5
	7.54	0.2969	53	91	36	8	R45419/64	R45319/64
	7.60	0.2992	53	91	36	8	R4547.6	R4537.6
	7.70	0.3031	53	91	36	8	R4547.7	R4537.7
	7.80	0.3071	53	91	36	8	R4547.8	R4537.8
5/16	7.90	0.3110	53	91	36	8	R4547.9	R4537.9
	7.94	0.3126	53	91	36	8	R4545/16	R4535/16
	8.00	0.3150	53	91	36	8	R4548.0	R4538.0
	8.05	0.3169	61	103	40	10		R4538.05
21/64	8.10	0.3189	61	103	40	10	R4548.1	R4538.1
	8.20	0.3228	61	103	40	10	R4548.2	R4538.2
	8.33	0.3280	61	103	40	10	R45421/64	R45321/64
	8.40	0.3307	61	103	40	10	R4548.4	R4538.4
	8.50	0.3346	61	103	40	10	R4548.5	R4538.5
	8.60	0.3386	61	103	40	10	R4548.6	R4538.6
	8.70	0.3425	61	103	40	10	R4548.7	R4538.7
11/32	8.73	0.3437	61	103	40	10	R45411/32	R45311/32
	8.80	0.3465	61	103	40	10	R4548.8	R4538.8
	8.90	0.3504	61	103	40	10	R4548.9	R4538.9
	9.00	0.3543	61	103	40	10	R4549.0	R4539.0
23/64	9.10	0.3583	61	103	40	10	R4549.1	R4539.1
	9.13	0.3594	61	103	40	10	R45423/64	R45323/64
	9.30	0.3661	61	103	40	10	R4549.3	R4539.3
	9.40	0.3701	61	103	40	10	R4549.4	R4539.4
3/8	9.50	0.3740	61	103	40	10	R4549.5	R4539.5
	9.52	0.3748	61	103	40	10	R4543/8	R4533/8
	9.60	0.3780	61	103	40	10	R4549.6	R4539.6
	9.70	0.3819	61	103	40	10	R4549.7	R4539.7
	9.80	0.3858	61	103	40	10	R4549.8	R4539.8
25/64	9.90	0.3898	61	103	40	10	R4549.9	R4539.9
	9.92	0.3906	61	103	40	10	R45425/64	R45325/64
	10.00	0.3937	61	103	40	10	R45410.0	R45310.0
	10.05	0.3957	70	118	45	12		R45310.05

d ₁ Ø Inch	d ₁ Ø _m , mm	d ₁ decimal Inch	l ₂ mm	l ₁ mm	l ₃ mm	d ₂ Ø _h mm	R454	R453
	10.10	0.3976	70	118	45	12	R45410.1	R45310.1
	10.20	0.4016	70	118	45	12	R45410.2	R45310.2
	10.30	0.4055	70	118	45	12	R45410.3	R45310.3
13/32	10.32	0.4063	70	118	45	12	R45413/32	R45313/32
	10.40	0.4094	70	118	45	12	R45410.4	R45310.4
	10.50	0.4134	70	118	45	12	R45410.5	R45310.5
	10.60	0.4173	70	118	45	12	R45410.6	R45310.6
27/64	10.72	0.4220	70	118	45	12	R45427/64	R45327/64
	11.00	0.4331	70	118	45	12	R45411.0	R45311.0
7/16	11.11	0.4374	70	118	45	12	R4547/16	R4537/16
	11.20	0.4409	70	118	45	12	R45411.2	R45311.2
	11.40	0.4488	70	118	45	12	R45411.4	R45311.4
	11.50	0.4528	70	118	45	12	R45411.5	R45311.5
29/64	11.51	0.4531	70	118	45	12	R45429/64	R45329/64
	11.60	0.4567	70	118	45	12	R45411.6	R45311.6
	11.80	0.4646	70	118	45	12	R45411.8	R45311.8
15/32	11.91	0.4689	70	118	45	12	R45415/32	R45315/32
	12.00	0.4724	70	118	45	12	R45412.0	R45312.0
	12.05	0.4744	76	124	45	14		R45312.05
	12.10	0.4764	76	124	45	14	R45412.1	
	12.20	0.4803	76	124	45	14	R45412.2	R45312.2
31/64	12.30	0.4843	76	124	45	14	R45431/64	R45331/64
	12.50	0.4921	76	124	45	14	R45412.5	R45312.5
	12.70	0.5000	76	124	45	14	R45412.7	R45312.7
1/2	12.70	0.5000	76	124	45	14	R4541/2	R4531/2
	12.80	0.5039	76	124	45	14	R45412.8	R45312.8
	13.00	0.5118	76	124	45	14	R45413.0	R45313.0
33/64	13.10	0.5157	76	124	45	14	R45433/64	R45333/64
17/32	13.49	0.5311	76	124	45	14	R45417/32	R45317/32
	13.50	0.5315	76	124	45	14	R45413.5	R45313.5
	13.80	0.5433	76	124	45	14	R45413.8	R45313.8
35/64	13.89	0.5469	76	124	45	14	R45435/64	R45335/64
	14.00	0.5512	76	124	45	14	R45414.0	R45314.0
	14.25	0.5610	82	133	48	16	R45414.25	R45314.25
9/16	14.29	0.5626	82	133	48	16	R4549/16	R4539/16
	14.50	0.5709	82	133	48	16	R45414.5	R45314.5
37/64	14.68	0.5780	82	133	48	16	R45437/64	R45337/64
	14.80	0.5827	82	133	48	16	R45414.8	R45314.8
	15.00	0.5906	82	133	48	16	R45415.0	R45315.0
19/32	15.08	0.5937	82	133	48	16	R45419/32	R45319/32
	15.10	0.5945	82	133	48	16	R45415.1	R45315.1
39/64	15.48	0.6094	82	133	48	16	R45439/64	R45339/64
	15.50	0.6102	82	133	48	16	R45415.5	R45315.5
	15.80	0.6220	82	133	48	16	R45415.8	R45315.8
5/8	15.88	0.6252	82	133	48	16	R4545/8	R4535/8
	16.00	0.6299	82	133	48	16	R45416.0	R45316.0
41/64	16.27	0.6406	91	143	48	18	R45441/64	R45341/64
	16.50	0.6496	91	143	48	18	R45416.5	R45316.5
21/32	16.67	0.6563	91	143	48	18	R45421/32	R45321/32
	17.00	0.6693	91	143	48	18	R45417.0	R45317.0
43/64	17.07	0.6720	91	143	48	18	R45443/64	R45343/64
11/16	17.46	0.6874	91	143	48	18	R45411/16	R45311/16
	17.50	0.6890	91	143	48	18	R45417.5	R45317.5
	17.80	0.7008	91	143	48	18	R45417.8	R45317.8
45/64	17.86	0.7031	91	143	48	18	R45445/64	R45345/64
	18.00	0.7087	91	143	48	18	R45418.0	R45318.0
23/32	18.26	0.7189	99	143	48	20		R45323/32
23/32	18.26	0.7189	99	153	50	20	R45423/32	
	18.50	0.7283	99	153	50	20	R45418.5	R45318.5
47/64	18.65	0.7343	99	153	50	20	R45447/64	R45347/64
	19.00	0.7480	99	153	50	20	R45419.0	R45319.0
3/4	19.05	0.7500	99	153	50	20	R4543/4	R4533/4
	19.50	0.7677	99	153	50	20	R45419.5	R45319.5
	19.80	0.7795	99	153	50	20	R45419.8	R45319.8
	20.00	0.7874	99	153	50	20	R45420.0	R45320.0

R459



R459

- MP-X 内冷钻头 8XD
- Broca MP-X com refrigeração interna 8XD
- Broca - MP-X - refrigeración interna 8XD
- MP-X Drill Oil Feed 8XD

Available January 2015
 Disponível em Janeiro 2015
 Disponible en Enero 2015
 Available January 2015

R459	▪	1.1	1.2	1.3	1.4	1.5	1.6	2.1	2.2	3.1	3.2	3.3	3.4	7.2	7.3	7.4
	•	2.3	6.1	6.2	6.3	6.4	7.1									



3.00 - 16.00

d ₁ Øm ₇ Inch	d ₂ Øm ₇ mm	d ₁ decimal Inch	l ₂ mm	l ₁ mm	l ₃ mm	d ₂ Øh ₆ mm	R459
	3.00	0.1181	37	79	36	6	R4593.0
	3.10	0.1220	37	79	36	6	R4593.1
1/8	3.18	0.1252	37	79	36	6	R4591/8
	3.20	0.1260	37	79	36	6	R4593.2
	3.30	0.1299	37	79	36	6	R4593.3
	3.40	0.1339	37	79	36	6	R4593.4
	3.50	0.1378	37	79	36	6	R4593.5
9/64	3.57	0.1406	37	79	36	6	R4599/64
	3.60	0.1417	37	79	36	6	R4593.6
	3.70	0.1457	37	79	36	6	R4593.7
	3.80	0.1496	48	90	36	6	R4593.8
	3.90	0.1535	48	90	36	6	R4593.9
5/32	3.97	0.1563	48	90	36	6	R4595/32
	4.00	0.1575	48	90	36	6	R4594.0
	4.10	0.1614	48	90	36	6	R4594.1
	4.20	0.1654	48	90	36	6	R4594.2
	4.30	0.1693	48	90	36	6	R4594.3
11/64	4.37	0.1720	48	90	36	6	R45911/64
	4.40	0.1732	48	90	36	6	R4594.4
	4.50	0.1772	48	90	36	6	R4594.5
	4.60	0.1811	48	90	36	6	R4594.6
	4.70	0.1850	62	104	36	6	R4594.7
3/16	4.76	0.1874	62	104	36	6	R4593/16
	4.80	0.1890	62	104	36	6	R4594.8
	4.90	0.1929	62	104	36	6	R4594.9
	5.00	0.1969	62	104	36	6	R4595.0
	5.10	0.2008	62	104	36	6	R4595.1
13/64	5.16	0.2031	62	104	36	6	R45913/64
	5.20	0.2047	62	104	36	6	R4595.2
	5.30	0.2087	62	104	36	6	R4595.3
	5.40	0.2126	62	104	36	6	R4595.4
	5.50	0.2165	62	104	36	6	R4595.5
7/32	5.56	0.2189	62	104	36	6	R4597/32
	5.60	0.2205	62	104	36	6	R4595.6

d_1 $\varnothing m_7$ Inch	d_1 $\varnothing m_7$ mm	d_1 decimal Inch	l_2 mm	l_1 mm	l_3 mm	d_2 $\varnothing h_6$ mm	R459
	5.70	0.2244	62	104	36	6	R4595.7
	5.80	0.2283	62	104	36	6	R4595.8
	5.90	0.2323	62	104	36	6	R4595.9
15/64	5.95	0.2343	62	104	36	6	R45915/64
	6.00	0.2362	62	104	36	6	R4596.0
	6.10	0.2402	84	126	36	8	R4596.1
	6.20	0.2441	84	126	36	8	R4596.2
	6.30	0.2480	84	126	36	8	R4596.3
1/4	6.35	0.2500	84	126	36	8	R4591/4
	6.40	0.2520	84	126	36	8	R4596.4
	6.50	0.2559	84	126	36	8	R4596.5
	6.60	0.2598	84	126	36	8	R4596.6
	6.70	0.2638	84	126	36	8	R4596.7
17/64	6.75	0.2657	84	126	36	8	R45917/64
	6.80	0.2677	84	126	36	8	R4596.8
	6.90	0.2717	84	126	36	8	R4596.9
	7.00	0.2756	84	126	36	8	R4597.0
	7.10	0.2795	84	126	36	8	R4597.1
9/32	7.14	0.2811	84	126	36	8	R4599/32
	7.20	0.2835	84	126	36	8	R4597.2
	7.30	0.2874	84	126	36	8	R4597.3
	7.40	0.2913	84	126	36	8	R4597.4
	7.50	0.2953	84	126	36	8	R4597.5
19/64	7.54	0.2969	84	126	36	8	R45919/64
	7.60	0.2992	84	126	36	8	R4597.6
	7.70	0.3031	84	126	36	8	R4597.7
	7.80	0.3071	84	126	36	8	R4597.8
	7.90	0.3110	84	126	36	8	R4597.9
5/16	7.94	0.3126	84	126	36	8	R4595/16
	8.00	0.3150	84	126	36	8	R4598.0
	8.10	0.3189	106	152	40	10	R4598.1
	8.20	0.3228	106	152	40	10	R4598.2
	8.30	0.3268	106	152	40	10	R4598.3
21/64	8.33	0.3280	106	152	40	10	R45921/64
	8.40	0.3307	106	152	40	10	R4598.4
	8.50	0.3346	106	152	40	10	R4598.5
	8.60	0.3386	106	152	40	10	R4598.6
	8.70	0.3425	106	152	40	10	R4598.7
11/32	8.73	0.3437	106	152	40	10	R45911/32
	8.80	0.3465	106	152	40	10	R4598.8
	8.90	0.3504	106	152	40	10	R4598.9
	9.00	0.3543	106	152	40	10	R4599.0
	9.10	0.3583	106	152	40	10	R4599.1
23/64	9.13	0.3594	106	152	40	10	R45923/64
	9.20	0.3622	106	152	40	10	R4599.2
	9.30	0.3661	106	152	40	10	R4599.3
	9.40	0.3701	106	152	40	10	R4599.4
	9.50	0.3740	106	152	40	10	R4599.5
3/8	9.53	0.3748	106	152	40	10	R4593/8
	9.60	0.3780	106	152	40	10	R4599.6
	9.70	0.3819	106	152	40	10	R4599.7
	9.80	0.3858	106	152	40	10	R4599.8
	9.90	0.3898	106	152	40	10	R4599.9
25/64	9.92	0.3906	106	152	40	10	R45925/64
	10.00	0.3937	106	152	40	10	R45910.0
	10.20	0.4016	128	180	45	12	R45910.2
	10.30	0.4055	128	180	45	12	R45910.3
13/32	10.32	0.4063	128	180	45	12	R45913/32
	10.40	0.4094	128	180	45	12	R45910.4
	10.50	0.4134	128	180	45	12	R45910.5
27/64	10.72	0.4220	128	180	45	12	R45927/64
	10.80	0.4252	128	180	45	12	R45910.8
	11.00	0.4331	128	180	45	12	R45911.0
7/16	11.11	0.4374	128	180	45	12	R4597/16
	11.20	0.4409	128	180	45	12	R45911.2
	11.30	0.4449	128	180	45	12	R45911.3
	11.50	0.4528	128	180	45	12	R45911.5
29/64	11.51	0.4531	128	180	45	12	R45929/64

d_1 $\varnothing m_7$ Inch	d_1 $\varnothing m_7$ mm	d_1 decimal Inch	l_2 mm	l_1 mm	l_3 mm	d_2 $\varnothing h_6$ mm	R459
	11.80	0.4646	128	180	45	12	R45911.8
15/32	11.91	0.4689	128	180	45	12	R45915/32
	12.00	0.4724	128	180	45	12	R45912.0
	12.20	0.4803	151	202	48	14	R45912.2
31/64	12.30	0.4843	151	202	48	14	R45931/64
	12.50	0.4921	151	202	48	14	R45912.5
1/2	12.70	0.5000	151	202	48	14	R4591/2
	12.80	0.5039	151	202	48	14	R45912.8
	13.00	0.5118	151	202	48	14	R45913.0
33/64	13.10	0.5157	151	202	48	14	R45933/64
17/32	13.49	0.5311	151	202	48	14	R45917/32
	13.50	0.5315	151	202	48	14	R45913.5
35/64	13.89	0.5469	151	202	48	14	R45935/64
	14.00	0.5512	151	202	48	14	R45914.0
	14.25	0.5610	172	227	48	16	R45914.25
9/16	14.29	0.5626	172	227	48	16	R4599/16
	14.50	0.5709	172	227	48	16	R45914.5
37/64	14.68	0.5780	172	227	48	16	R45937/64
	15.00	0.5906	172	227	48	16	R45915.0
19/32	15.08	0.5937	172	227	48	16	R45919/32
	15.10	0.5945	172	227	48	16	R45915.1
39/64	15.48	0.6094	172	227	48	16	R45939/64
	15.50	0.6102	172	227	48	16	R45915.5
5/8	15.88	0.6252	172	227	48	16	R4595/8
	16.00	0.6299	172	227	48	16	R45916.0

A122



A122

- 定心钻
- Broca para furo guia
- Broca para centrados
- Spotting Drill

总长符合 DIN 1897
 Comprimento Total de acordo com DIN1897
 Longitud total según DIN 1897
 Overall Length to DIN 1897

A122	▪	1.1	1.2	1.3	6.1	6.2	6.3	6.4	7.1	7.2											
	•	1.4	1.5	1.6	2.1	2.2	2.3	3.1	3.2	3.3	3.4	4.1	4.2	4.3	5.1	5.2	5.3	7.3	7.4	8.1	8.2
		8.3	9.1																		



d_1 $\varnothing h_8$ mm	d_1 decimal Inch	l_2 mm	l_1 mm	A122
6.00	0.2362	30	66	A1226.0X90
6.00	0.2362	30	66	A1226.0X120
8.00	0.3150	33	79	A1228.0X90
8.00	0.3150	33	79	A1228.0X120
10.00	0.3937	35	89	A12210.0X90
10.00	0.3937	35	89	A12210.0X120
12.00	0.4724	40	102	A12212.0X90
12.00	0.4724	40	102	A12212.0X120
16.00	0.6299	40	115	A12216.0X90
16.00	0.6299	40	115	A12216.0X120
20.00	0.7874	55	131	A12220.0X90
20.00	0.7874	55	131	A12220.0X120

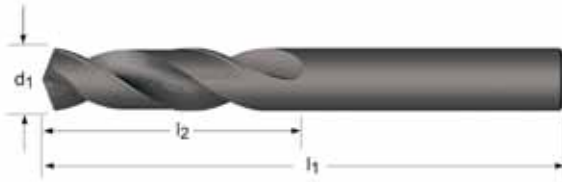

d_1 $\varnothing h_8$ Inch	d_1 $\varnothing h_8$ mm	d_1 decimal Inch	l_2 mm	l_1 mm	A120	A022	A620	A117
	0.50	0.0197	3	20	A120.5	A022.5		
	0.60	0.0236	3.5	21	A120.6	A022.6		
	0.70	0.0276	4.5	23	A120.7	A022.7		
1/32	0.79	0.0311	5	24	A1201/32			
1/32	0.79	0.0311	13	35		A0221/32		
	0.80	0.0315	5	24	A120.8	A022.8		
	0.90	0.0354	5.5	25	A120.9	A022.9		
	1.00	0.0394	6	26	A1201.0	A0221.0		A1171.0
	1.10	0.0433	7	28	A1201.1	A0221.1		A1171.1
3/64	1.19	0.0469	8	30	A1203/64			
3/64	1.19	0.0469	13	35		A0223/64		
	1.20	0.0472	8	30	A1201.2	A0221.2		A1171.2
	1.30	0.0512	8	30	A1201.3	A0221.3		A1171.3
	1.40	0.0551	9	32	A1201.4	A0221.4		A1171.4
	1.50	0.0591	9	32	A1201.5	A0221.5		A1171.5
1/16	1.59	0.0626	10	34	A1201/16			
1/16	1.59	0.0626	16	41		A0221/16		
	1.60	0.0630	10	34	A1201.6	A0221.6		A1171.6
	1.70	0.0669	10	34	A1201.7	A0221.7		A1171.7
	1.80	0.0709	11	36	A1201.8	A0221.8		A1171.8
	1.90	0.0748	11	36	A1201.9	A0221.9		A1171.9
5/64	1.98	0.0780	12	38	A1205/64			
5/64	1.98	0.0780	17	43		A0225/64		
	2.00	0.0787	12	38	A1202.0	A0222.0		A1172.0
	2.10	0.0827	12	38	A1202.1	A0222.1		A1172.1
	2.20	0.0866	13	40	A1202.2	A0222.2		A1172.2
	2.25	0.0886	13	40	A1202.25	A0222.25		
	2.30	0.0906	13	40	A1202.3	A0222.3		A1172.3
3/32	2.38	0.0937	14	43	A1203/32			
3/32	2.38	0.0937	20	45		A0223/32		
	2.40	0.0945	14	43	A1202.4	A0222.4		A1172.4
	2.50	0.0984	14	43	A1202.5	A0222.5	A6202.5	A1172.5
	2.60	0.1024	14	43	A1202.6	A0222.6	A6202.6	A1172.6
	2.65	0.1043	14	43	A1202.65	A0222.65		
	2.70	0.1063	16	46	A1202.7	A0222.7	A6202.7	A1172.7
7/64	2.78	0.1094	16	46	A1207/64			
7/64	2.78	0.1094	22	47		A0227/64		
	2.80	0.1102	16	46	A1202.8	A0222.8	A6202.8	A1172.8
	2.90	0.1142	16	46	A1202.9	A0222.9	A6202.9	A1172.9
	3.00	0.1181	16	46	A1203.0	A0223.0	A6203.0	A1173.0
	3.10	0.1220	18	49	A1203.1	A0223.1	A6203.1	A1173.1
1/8	3.18	0.1252	18	49	A1201/8			A1171/8
1/8	3.18	0.1252	23	49		A0221/8		
	3.20	0.1260	18	49	A1203.2	A0223.2	A6203.2	A1173.2
	3.25	0.1280	18	49	A1203.25	A0223.25		
	3.30	0.1299	18	49	A1203.3	A0223.3	A6203.3	A1173.3
	3.40	0.1339	20	52	A1203.4	A0223.4	A6203.4	A1173.4
	3.50	0.1378	20	52	A1203.5	A0223.5	A6203.5	A1173.5
9/64	3.57	0.1406	20	52	A1209/64			
9/64	3.57	0.1406	25	50		A0229/64		
	3.60	0.1417	20	52	A1203.6	A0223.6	A6203.6	A1173.6
		0.1417	20	52				
	3.70	0.1457	20	52	A1203.7	A0223.7	A6203.7	A1173.7
	3.80	0.1496	22	55	A1203.8	A0223.8	A6203.8	A1173.8

d ₁ Øh ₈ Inch	d ₁ Øh ₈ mm	d ₁ decimal Inch	l ₂ mm	l ₁ mm	A120	A022	A620	A117
	3.90	0.1535	22	55	A1203.9	A0223.9	A6203.9	A1173.9
5/32	3.97	0.1563	22	55	A1205/32			A1175/32
5/32	3.97	0.1563	26	53		A0225/32		
	4.00	0.1575	22	55	A1204.0	A0224.0	A6204.0	A1174.0
	4.10	0.1614	22	55	A1204.1	A0224.1	A6204.1	A1174.1
	4.20	0.1654	22	55	A1204.2	A0224.2	A6204.2	A1174.2
	4.30	0.1693	24	58	A1204.3	A0224.3	A6204.3	A1174.3
11/64	4.37	0.1720	24	58	A12011/64			
11/64	4.37	0.1720	28	55		A02211/64		
	4.40	0.1732	24	58	A1204.4	A0224.4	A6204.4	A1174.4
	4.50	0.1772	24	58	A1204.5	A0224.5	A6204.5	A1174.5
	4.60	0.1811	24	58	A1204.6	A0224.6	A6204.6	A1174.6
	4.70	0.1850	24	58	A1204.7	A0224.7	A6204.7	A1174.7
3/16	4.76	0.1874	26	62	A1203/16			A1173/16
3/16	4.76	0.1874	30	57		A0223/16		
	4.80	0.1890	26	62	A1204.8	A0224.8	A6204.8	A1174.8
	4.90	0.1929	26	62	A1204.9	A0224.9	A6204.9	A1174.9
	5.00	0.1969	26	62	A1205.0	A0225.0	A6205.0	A1175.0
	5.10	0.2008	26	62	A1205.1	A0225.1	A6205.1	A1175.1
13/64	5.16	0.2031	26	62	A12013/64			
13/64	5.16	0.2031	31	58		A02213/64		
	5.20	0.2047	26	62	A1205.2	A0225.2	A6205.2	A1175.2
	5.30	0.2087	26	62	A1205.3	A0225.3	A6205.3	A1175.3
	5.40	0.2126	28	66	A1205.4	A0225.4	A6205.4	A1175.4
	5.50	0.2165	28	66	A1205.5	A0225.5	A6205.5	A1175.5
7/32	5.56	0.2189	28	66	A1207/32			
7/32	5.56	0.2189	33	61		A0227/32		
	5.60	0.2205	28	66	A1205.6	A0225.6	A6205.6	A1175.6
	5.70	0.2244	28	66	A1205.7	A0225.7	A6205.7	A1175.7
	5.80	0.2283	28	66	A1205.8	A0225.8	A6205.8	A1175.8
	5.90	0.2323	28	66	A1205.9	A0225.9	A6205.9	A1175.9
15/64	5.95	0.2343	28	66	A12015/64			
15/64	5.95	0.2343	34	63		A02215/64		
	6.00	0.2362	28	66	A1206.0	A0226.0	A6206.0	A1176.0
	6.10	0.2402	31	70	A1206.1	A0226.1	A6206.1	A1176.1
	6.20	0.2441	31	70	A1206.2	A0226.2	A6206.2	A1176.2
	6.30	0.2480	31	70	A1206.3	A0226.3	A6206.3	A1176.3
1/4	6.35	0.2500	31	70	A1201/4			A1171/4
1/4	6.35	0.2500	36	65		A0221/4		
	6.40	0.2520	31	70	A1206.4	A0226.4	A6206.4	A1176.4
	6.50	0.2559	31	70	A1206.5	A0226.5	A6206.5	A1176.5
	6.60	0.2598	31	70	A1206.6	A0226.6	A6206.6	A1176.6
	6.70	0.2638	31	70	A1206.7	A0226.7	A6206.7	A1176.7
	6.80	0.2677	34	74	A1206.8	A0226.8	A6206.8	A1176.8
	6.90	0.2717	34	74	A1206.9	A0226.9	A6206.9	A1176.9
	7.00	0.2756	34	74	A1207.0	A0227.0	A6207.0	A1177.0
	7.10	0.2795	34	74	A1207.1	A0227.1	A6207.1	A1177.1
9/32	7.14	0.2811	34	74	A1209/32			
9/32	7.14	0.2811	40	70		A0229/32		
	7.20	0.2835	34	74	A1207.2	A0227.2	A6207.2	A1177.2
	7.30	0.2874	34	74	A1207.3	A0227.3	A6207.3	A1177.3
	7.40	0.2913	34	74	A1207.4	A0227.4	A6207.4	A1177.4
	7.50	0.2953	34	74	A1207.5	A0227.5	A6207.5	A1177.5
	7.60	0.2992	37	79	A1207.6	A0227.6	A6207.6	A1177.6
	7.70	0.3031	37	79	A1207.7	A0227.7	A6207.7	A1177.7
	7.80	0.3071	37	79	A1207.8	A0227.8	A6207.8	A1177.8
	7.90	0.3110	37	79	A1207.9	A0227.9	A6207.9	A1177.9
5/16	7.94	0.3126	37	79	A1205/16			A1175/16
5/16	7.94	0.3126	43	73		A0225/16		
	8.00	0.3150	37	79	A1208.0	A0228.0	A6208.0	A1178.0
	8.10	0.3189	37	79	A1208.1	A0228.1	A6208.1	A1178.1
	8.20	0.3228	37	79	A1208.2	A0228.2	A6208.2	A1178.2
	8.30	0.3268	37	79	A1208.3	A0228.3	A6208.3	A1178.3
	8.40	0.3307	37	79	A1208.4	A0228.4	A6208.4	A1178.4
	8.50	0.3346	37	79	A1208.5	A0228.5	A6208.5	A1178.5
	8.60	0.3386	40	84	A1208.6	A0228.6	A6208.6	A1178.6
	8.70	0.3425	40	84	A1208.7	A0228.7	A6208.7	A1178.7
11/32	8.73	0.3437	40	84	A12011/32			

d ₁ Øh ₈ Inch	d ₁ Øh ₈ mm	d ₁ decimal Inch	l ₂ mm	l ₁ mm	A120	A022	A620	A117
11/32	8.73	0.3437	45	78		A02211/32		
	8.80	0.3465	40	84	A1208.8	A0228.8	A6208.8	A1178.8
	8.90	0.3504	40	84	A1208.9	A0228.9	A6208.9	A1178.9
	9.00	0.3543	40	84	A1209.0	A0229.0	A6209.0	A1179.0
	9.10	0.3583	40	84	A1209.1	A0229.1	A6209.1	A1179.1
	9.20	0.3622	40	84	A1209.2	A0229.2	A6209.2	A1179.2
	9.30	0.3661	40	84	A1209.3	A0229.3	A6209.3	A1179.3
	9.40	0.3701	40	84	A1209.4	A0229.4	A6209.4	A1179.4
	9.50	0.3740	40	84	A1209.5	A0229.5	A6209.5	A1179.5
3/8	9.52	0.3748	43	89	A1203/8			A1173/8
3/8	9.52	0.3748	48	81		A0223/8		
	9.60	0.3780	43	89	A1209.6	A0229.6	A6209.6	A1179.6
	9.70	0.3819	43	89	A1209.7	A0229.7	A6209.7	A1179.7
	9.80	0.3858	43	89	A1209.8	A0229.8	A6209.8	A1179.8
	9.90	0.3898	43	89	A1209.9	A0229.9	A6209.9	A1179.9
	10.00	0.3937	43	89	A12010.0	A02210.0	A62010.0	A11710.0
	10.10	0.3976	43	89	A12010.1	A02210.1		
	10.20	0.4016	43	89	A12010.2	A02210.2	A62010.2	A11710.2
	10.30	0.4055	43	89	A12010.3	A02210.3	A62010.3	
13/32	10.32	0.4063	43	89	A12013/32			
13/32	10.32	0.4063	51	86		A02213/32		
	10.40	0.4094	43	89	A12010.4	A02210.4	A62010.4	
	10.50	0.4134	43	89	A12010.5	A02210.5	A62010.5	A11710.5
	10.60	0.4173	43	89	A12010.6	A02210.6		
	10.70	0.4213	47	95	A12010.7	A02210.7		
	10.80	0.4252	47	95	A12010.8	A02210.8	A62010.8	
	10.90	0.4291	47	95	A12010.9	A02210.9		
	11.00	0.4331	47	95	A12011.0	A02211.0	A62011.0	A11711.0
	11.10	0.4370	47	95	A12011.1	A02211.1		
7/16	11.11	0.4374	47	95	A1207/16			
7/16	11.11	0.4374	54	89		A0227/16		
	11.20	0.4409	47	95	A12011.2	A02211.2		
	11.30	0.4449	47	95	A12011.3	A02211.3		
	11.50	0.4528	47	95	A12011.5	A02211.5	A62011.5	A11711.5
	11.60	0.4567	47	95	A12011.6	A02211.6		
	11.70	0.4606	47	95	A12011.7	A02211.7		
	11.80	0.4646	47	95	A12011.8	A02211.8		
	11.90	0.4685	51	102	A12011.9	A02211.9		
	12.00	0.4724	51	102	A12012.0	A02212.0	A62012.0	A11712.0
	12.10	0.4764	51	102	A12012.1	A02212.1		
	12.20	0.4803	51	102	A12012.2	A02212.2	A62012.2	
	12.50	0.4921	51	102	A12012.5	A02212.5	A62012.5	
1/2	12.70	0.5000	51	102	A1201/2			A1171/2
1/2	12.70	0.5000	60	98		A0221/2		
	12.80	0.5039	51	102			A62012.8	
	13.00	0.5118	51	102	A12013.0	A02213.0	A62013.0	A11713.0
	13.50	0.5315	54	107	A12013.5	A02213.5		
	14.00	0.5512	54	107	A12014.0	A02214.0		
9/16	14.29	0.5626	56	111	A1209/16			
9/16	14.29	0.5626	67	105		A0229/16		
	14.50	0.5709	56	111	A12014.5	A02214.5		
	15.00	0.5906	56	111	A12015.0	A02215.0		
	15.50	0.6102	58	115	A12015.5	A02215.5		
5/8	15.88	0.6252	58	115	A1205/8			
5/8	15.88	0.6252	73	111		A0225/8		
	16.00	0.6299	58	115	A12016.0	A02216.0		
	16.50	0.6496	60	119	A12016.5			
	17.00	0.6693	60	119	A12017.0			
11/16	17.46	0.6874	62	123	A12011/16			
	17.50	0.6890	62	123	A12017.5			
	18.00	0.7087	62	123	A12018.0			
	18.50	0.7283	64	127	A12018.5			
	19.00	0.7480	64	127	A12019.0			
3/4	19.05	0.7500	66	131	A1203/4			
	19.50	0.7677	66	131	A12019.5			
	20.00	0.7874	66	131	A12020.0			
	20.50	0.8071	68	136	A12020.5			
13/16	20.64	0.8126	68	136	A12013/16			

d_1 \varnothing_{h_8} Inch	d_1 \varnothing_{h_8} mm	d_1 decimal Inch	l_2 mm	l_1 mm	A120	A022	A620	A117
	21.00	0.8268	68	136	A12021.0			
	22.00	0.8661	70	141	A12022.0			
7/8	22.22	0.8748	70	141	A1207/8			
	23.00	0.9055	72	146	A12023.0			
15/16	23.81	0.9374	75	151	A12015/16			
	24.00	0.9449	75	151	A12024.0			
	25.00	0.9843	75	151	A12025.0			

A520



- ADX 短型钻头
- Broca ADX Serie Extra Curta
- Broca ADX , serie extra corta
- ADX Stub Drill

A520

A520	▪	1.1	1.2	1.3	1.4	1.5	2.1	2.2	2.3	3.1	3.2	3.3	3.4	4.1	4.2	6.2	6.3	7.2	7.3	7.4	8.2	
		8.3																				
	•	1.6	4.3	5.1	5.2	5.3	6.1	6.4	7.1	8.1												



d_1 $\varnothing h_8$ Inch	d_1 $\varnothing h_8$ mm	d_1 decimal Inch	l_2 mm	l_1 mm	A520
	3.00	0.1181	16	46	A5203.0
	3.10	0.1220	18	49	A5203.1
1/8	3.18	0.1252	18	49	A5201/8
	3.20	0.1260	18	49	A5203.2
	3.30	0.1299	18	49	A5203.3
	3.40	0.1339	20	52	A5203.4
	3.50	0.1378	20	52	A5203.5
9/64	3.57	0.1406	20	52	A5209/64
	3.60	0.1417	20	52	A5203.6
	3.70	0.1457	20	52	A5203.7
	3.80	0.1496	22	55	A5203.8
	3.90	0.1535	22	55	A5203.9
5/32	3.97	0.1563	22	55	A5205/32
	4.00	0.1575	22	55	A5204.0
	4.10	0.1614	22	55	A5204.1
	4.20	0.1654	22	55	A5204.2
	4.30	0.1693	24	58	A5204.3
11/64	4.37	0.1720	24	58	A52011/64
	4.40	0.1732	24	58	A5204.4
	4.50	0.1772	24	58	A5204.5
	4.60	0.1811	24	58	A5204.6
	4.70	0.1850	24	58	A5204.7
3/16	4.76	0.1874	26	62	A5203/16
	4.80	0.1890	26	62	A5204.8
	4.90	0.1929	26	62	A5204.9
	5.00	0.1969	26	62	A5205.0
	5.10	0.2008	26	62	A5205.1
13/64	5.16	0.2031	26	62	A52013/64
	5.20	0.2047	26	62	A5205.2
	5.30	0.2087	26	62	A5205.3
	5.40	0.2126	28	66	A5205.4
	5.50	0.2165	28	66	A5205.5
7/32	5.56	0.2189	28	66	A5207/32
	5.60	0.2205	28	66	A5205.6
	5.70	0.2244	28	66	A5205.7
	5.80	0.2283	28	66	A5205.8

d_1 $\varnothing h_8$ Inch	d_1 $\varnothing h_8$ mm	d_1 decimal Inch	l_2 mm	l_1 mm	A520
	5.90	0.2323	28	66	A5205.9
15/64	5.95	0.2343	28	66	A52015/64
	6.00	0.2362	28	66	A5206.0
	6.10	0.2402	31	70	A5206.1
	6.20	0.2441	31	70	A5206.2
	6.30	0.2480	31	70	A5206.3
1/4	6.35	0.2500	31	70	A5201/4
	6.40	0.2520	31	70	A5206.4
	6.50	0.2559	31	70	A5206.5
	6.60	0.2598	31	70	A5206.6
	6.70	0.2638	31	70	A5206.7
17/64	6.75	0.2657	34	74	A52017/64
	6.80	0.2677	34	74	A5206.8
	6.90	0.2717	34	74	A5206.9
	7.00	0.2756	34	74	A5207.0
	7.10	0.2795	34	74	A5207.1
9/32	7.14	0.2811	34	74	A5209/32
	7.20	0.2835	34	74	A5207.2
	7.30	0.2874	34	74	A5207.3
	7.40	0.2913	34	74	A5207.4
	7.50	0.2953	34	74	A5207.5
19/64	7.54	0.2969	37	79	A52019/64
	7.60	0.2992	37	79	A5207.6
	7.70	0.3031	37	79	A5207.7
	7.80	0.3071	37	79	A5207.8
	7.90	0.3110	37	79	A5207.9
5/16	7.94	0.3126	37	79	A5205/16
	8.00	0.3150	37	79	A5208.0
	8.10	0.3189	37	79	A5208.1
	8.20	0.3228	37	79	A5208.2
	8.30	0.3268	37	79	A5208.3
21/64	8.33	0.3280	37	79	A52021/64
	8.40	0.3307	37	79	A5208.4
	8.50	0.3346	37	79	A5208.5
	8.60	0.3386	40	84	A5208.6
	8.70	0.3425	40	84	A5208.7
11/32	8.73	0.3437	40	84	A52011/32
	8.80	0.3465	40	84	A5208.8
	8.90	0.3504	40	84	A5208.9
	9.00	0.3543	40	84	A5209.0
	9.10	0.3583	40	84	A5209.1
23/64	9.13	0.3594	40	84	A52023/64
	9.20	0.3622	40	84	A5209.2
	9.30	0.3661	40	84	A5209.3
	9.40	0.3701	40	84	A5209.4
	9.50	0.3740	40	84	A5209.5
3/8	9.52	0.3748	43	89	A5203/8
	9.60	0.3780	43	89	A5209.6
	9.70	0.3819	43	89	A5209.7
	9.80	0.3858	43	89	A5209.8
	9.90	0.3898	43	89	A5209.9
25/64	9.92	0.3906	43	89	A52025/64
	10.00	0.3937	43	89	A52010.0
	10.10	0.3976	43	89	A52010.1
	10.20	0.4016	43	89	A52010.2
	10.30	0.4055	43	89	A52010.3
13/32	10.32	0.4063	43	89	A52013/32
	10.40	0.4094	43	89	A52010.4
	10.50	0.4134	43	89	A52010.5
	10.60	0.4173	43	89	A52010.6
	10.70	0.4213	47	95	A52010.7
27/64	10.72	0.4220	47	95	A52027/64
	10.80	0.4252	47	95	A52010.8
	10.90	0.4291	47	95	A52010.9
	11.00	0.4331	47	95	A52011.0
	11.10	0.4370	47	95	A52011.1
7/16	11.11	0.4374	47	95	A5207/16
	11.20	0.4409	47	95	A52011.2
	11.30	0.4449	47	95	A52011.3
	11.40	0.4488	47	95	A52011.4

d_1 $\varnothing h_8$ Inch	d_1 $\varnothing h_8$ mm	d_1 decimal Inch	l_2 mm	l_1 mm	A520
29/64	11.50	0.4528	47	95	A52011.5
	11.51	0.4531	47	95	A52029/64
	11.60	0.4567	47	95	A52011.6
	11.70	0.4606	47	95	A52011.7
	11.80	0.4646	47	95	A52011.8
15/32	11.90	0.4685	51	102	A52011.9
	11.91	0.4689	51	102	A52015/32
	12.00	0.4724	51	102	A52012.0
	12.10	0.4764	51	102	A52012.1
	12.20	0.4803	51	102	A52012.2
31/64	12.30	0.4843	51	102	A52012.3
	12.30	0.4843	51	102	A52031/64
	12.40	0.4882	51	102	A52012.4
	12.50	0.4921	51	102	A52012.5
	12.60	0.4961	51	102	A52012.6
1/2	12.70	0.5000	51	102	A52012.7
	12.70	0.5000	51	102	A5201/2
	12.80	0.5039	51	102	A52012.8
	12.90	0.5079	51	102	A52012.9
	13.00	0.5118	51	102	A52013.0

A124



A124

- 短型钻头 - 4 后面钻尖
 - Broca Serie Extra Curta 4 Faces
 - Broca extra corta 4 caras
 - Stub Drill 4 facet
- 扁尾符合 DIN 1809
Arraste de acordo com a DIN 1809
Lengüeta según DIN 1809
Tang to DIN 1809

A124	▪	3.1	3.2	3.3	3.4											
	•	1.5	1.6	2.2	2.3	4.1	4.2	4.3	5.1	5.2	5.3	6.2	6.3	6.4	8.2	9.1

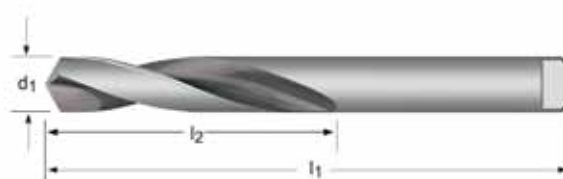

d_1 Ø mm	d_1 decimal Inch	l_2 mm	l_1 mm	A124
3.00	0.1181	20	50	A1243.0
3.20	0.1260	25	56	A1243.2
3.50	0.1378	25	56	A1243.5
4.00	0.1575	25	56	A1244.0
4.20	0.1654	28	63	A1244.2
4.50	0.1772	28	63	A1244.5
4.80	0.1890	28	63	A1244.8
5.00	0.1969	28	63	A1245.0
5.20	0.2047	32	71	A1245.2
5.50	0.2165	32	71	A1245.5
5.80	0.2283	32	71	A1245.8
6.00	0.2362	32	71	A1246.0
6.50	0.2559	32	71	A1246.5
6.80	0.2677	40	80	A1246.8
7.00	0.2756	40	80	A1247.0
7.50	0.2953	40	80	A1247.5
8.00	0.3150	40	80	A1248.0
8.50	0.3346	50	90	A1248.5
9.00	0.3543	50	90	A1249.0
9.50	0.3740	50	90	A1249.5
10.00	0.3937	56	100	A12410.0
10.50	0.4134	56	100	A12410.5
11.00	0.4331	56	100	A12411.0
11.50	0.4528	63	112	A12411.5
12.00	0.4724	63	112	A12412.0
13.00	0.5118	63	112	A12413.0
14.00	0.5512	71	125	A12414.0
15.00	0.5906	71	125	A12415.0
16.00	0.6299	80	140	A12416.0

A720



- 微型钻头
- Micro Brocas
- Micro Broca
- Micro Drill

A720

A720	▪	1.1	1.2	1.3	1.4	3.1	3.2														
	•	1.5	1.6	2.1	2.2	2.3	3.3	3.4	4.1	4.2	4.3	5.1	5.2	5.3	6.1	6.2	6.3	6.4	7.1	7.2	7.3
		7.4	8.1	8.2																	



d_1 Ø mm	d_1 decimal Inch	l_2 mm	l_1 mm	d_2 Ø mm	A720
0.15	0.0059	1.0	25	1	A720.15
0.16	0.0063	1.4	25	1	A720.16
0.17	0.0067	1.4	25	1	A720.17
0.18	0.0070	1.4	25	1	A720.18
0.20	0.0078	1.8	25	1	A720.2
0.22	0.0087	1.8	25	1	A720.22
0.25	0.0098	2.2	25	1	A720.25
0.27	0.0106	2.2	25	1	A720.27
0.28	0.0110	2.2	25	1	A720.28
0.30	0.0118	2.2	25	1	A720.3
0.35	0.0138	2.8	25	1	A720.35
0.38	0.0150	2.8	25	1	A720.38
0.39	0.0154	3.6	25	1	A720.39
0.40	0.0157	3.6	25	1	A720.4
0.45	0.0177	3.6	25	1	A720.45
0.50	0.0197	4.0	25	1	A720.5
0.55	0.0217	4.5	25	1	A720.55
0.60	0.0236	4.5	25	1	A720.6
0.62	0.0244	5.0	25	1	A720.62
0.65	0.0256	5.0	25	1	A720.65
0.70	0.0276	5.6	25	1	A720.7
0.75	0.0295	5.6	25	1	A720.75
0.80	0.0315	6.3	25	1.5	A720.8
0.85	0.0335	6.3	25	1.5	A720.85
0.90	0.0354	7.1	25	1.5	A720.9
0.95	0.0374	7.1	25	1.5	A720.95
1.00	0.0394	8.0	25	1.5	A7201.0
1.05	0.0413	8.0	25	1.5	A7201.05
1.10	0.0433	9.0	25	1.5	A7201.1
1.20	0.0472	10.0	25	1.5	A7201.2
1.30	0.0512	10.0	25	1.5	A7201.3
1.40	0.0551	11.2	25	1.5	A7201.4



- A920**
- PFX 短型钻头
 - PFX - Broca Serie Extra Curta
- A921**
- Broca PFX Extra Corta
 - PFX Stub Drill

A920	▪	1.1	1.2	1.3	1.4	1.5	1.6	2.1	2.2	2.3	4.1	4.2	4.3	5.1	5.2	5.3	7.2
	•	3.1	3.2	3.3	3.4	6.1	6.2	6.3	6.4	7.1	7.3	7.4	8.1	8.2			
A921	▪	1.1	1.2	1.3	1.4	1.5	1.6	2.1	2.2	2.3	3.1	3.2	3.3	3.4	7.4		
	•	4.1	4.2	4.3	5.1	5.2	5.3	6.3	6.4								

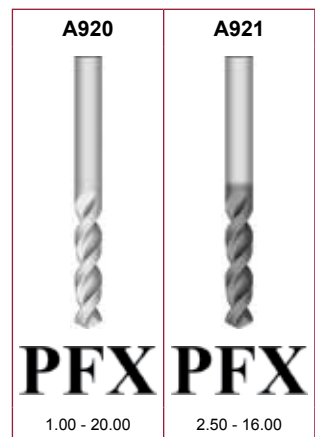
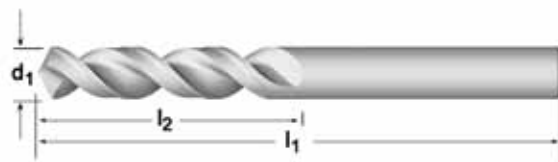

d_1 $\varnothing h_8$ Inch	d_1 $\varnothing h_8$ mm	d_1 decimal Inch	l_2 mm	l_1 mm	A920	A921
	1.00	0.0394	6	26	A9201.0	
	1.10	0.0433	7	28	A9201.1	
3/64	1.19	0.0469	13	35	A9203/64	
	1.20	0.0472	8	30	A9201.2	
	1.25	0.0492	8	30	A9201.25	
	1.30	0.0512	8	30	A9201.3	
	1.35	0.0531	9	32	A9201.35	
	1.40	0.0551	9	32	A9201.4	
	1.45	0.0571	9	32	A9201.45	
	1.50	0.0591	9	32	A9201.5	
	1.55	0.0610	10	34	A9201.55	
1/16	1.59	0.0626	16	41	A9201/16	
	1.60	0.0630	10	34	A9201.6	
	1.70	0.0669	10	34	A9201.7	
	1.75	0.0689	11	36	A9201.75	
	1.80	0.0709	11	36	A9201.8	
	1.90	0.0748	11	36	A9201.9	
5/64	1.98	0.0780	17	43	A9205/64	
	2.00	0.0787	12	38	A9202.0	
	2.10	0.0827	12	38	A9202.1	
	2.15	0.0846	13	40	A9202.15	
	2.20	0.0866	13	40	A9202.2	
	2.30	0.0906	13	40	A9202.3	
	2.35	0.0925	14	43	A9202.35	
3/32	2.38	0.0937	19	41	A9203/32	
	2.40	0.0945	14	43	A9202.4	
	2.50	0.0984	14	43	A9202.5	A9212.5
	2.60	0.1024	14	43	A9202.6	A9212.6
	2.65	0.1043	14	43	A9202.65	
	2.70	0.1063	16	46	A9202.7	A9212.7

d_1 $\varnothing h_8$ Inch	d_1 $\varnothing h_8$ mm	d_1 decimal Inch	l_2 mm	l_1 mm	A920	A921
7/64	2.78	0.1094	21	46	A9207/64	A9217/64
	2.80	0.1102	16	46	A9202.8	
	2.90	0.1142	16	46	A9202.9	A9212.9
	3.00	0.1181	16	46	A9203.0	A9213.0
1/8	3.10	0.1220	18	49	A9203.1	A9213.1
	3.18	0.1252	22	48	A9201/8	A9211/8
	3.20	0.1260	18	49	A9203.2	A9213.2
	3.30	0.1299	18	49	A9203.3	A9213.3
	3.40	0.1339	20	52	A9203.4	A9213.4
9/64	3.50	0.1378	20	52	A9203.5	A9213.5
	3.57	0.1406	24	49	A9209/64	A9219/64
	3.60	0.1417	20	52	A9203.6	A9213.6
	3.70	0.1457	20	52	A9203.7	A9213.7
	3.80	0.1496	22	55	A9203.8	A9213.8
5/32	3.90	0.1535	22	55	A9203.9	A9213.9
	3.97	0.1563	25	52	A9205/32	A9215/32
	4.00	0.1575	22	55	A9204.0	A9214.0
	4.10	0.1614	22	55	A9204.1	A9214.1
	4.20	0.1654	22	55	A9204.2	A9214.2
11/64	4.30	0.1693	24	58	A9204.3	A9214.3
	4.37	0.1720	27	54	A92011/64	A92111/64
	4.40	0.1732	24	58	A9204.4	A9214.4
	4.50	0.1772	24	58	A9204.5	A9214.5
	4.60	0.1811	24	58	A9204.6	A9214.6
3/16	4.70	0.1850	24	58	A9204.7	A9214.7
	4.76	0.1874	29	56	A9203/16	A9213/16
	4.80	0.1890	26	62	A9204.8	A9214.8
	4.90	0.1929	26	62	A9204.9	A9214.9
	5.00	0.1969	26	62	A9205.0	A9215.0
13/64	5.10	0.2008	26	62	A9205.1	A9215.1
	5.16	0.2031	30	57	A92013/64	A92113/64
	5.20	0.2047	26	62	A9205.2	A9215.2
	5.30	0.2087	26	62	A9205.3	A9215.3
	5.40	0.2126	28	66	A9205.4	A9215.4
7/32	5.50	0.2165	28	66	A9205.5	A9215.5
	5.56	0.2189	32	60	A9207/32	A9217/32
	5.60	0.2205	28	66	A9205.6	A9215.6
	5.70	0.2244	28	66	A9205.7	A9215.7
	5.80	0.2283	28	66	A9205.8	A9215.8
15/64	5.90	0.2323	28	66	A9205.9	A9215.9
	5.95	0.2343	33	62	A92015/64	A92115/64
	6.00	0.2362	28	66	A9206.0	A9216.0
	6.10	0.2402	31	70	A9206.1	A9216.1
	6.20	0.2441	31	70	A9206.2	A9216.2
1/4	6.30	0.2480	31	70	A9206.3	A9216.3
	6.35	0.2500	35	64	A9201/4	A9211/4
	6.40	0.2520	31	70	A9206.4	A9216.4
	6.50	0.2559	31	70	A9206.5	A9216.5
	6.60	0.2598	31	70	A9206.6	A9216.6
17/64	6.70	0.2638	31	70	A9206.7	A9216.7
	6.75	0.2657	37	67	A92017/64	A92117/64
	6.80	0.2677	34	74	A9206.8	A9216.8
	6.90	0.2717	34	74	A9206.9	A9216.9
	7.00	0.2756	34	74	A9207.0	A9217.0
9/32	7.10	0.2795	34	74	A9207.1	A9217.1
	7.14	0.2811	38	68	A9209/32	A9219/32
	7.20	0.2835	34	74	A9207.2	A9217.2
	7.30	0.2874	34	74	A9207.3	A9217.3
	7.40	0.2913	34	74	A9207.4	A9217.4
19/64	7.50	0.2953	34	74	A9207.5	A9217.5
	7.54	0.2969	40	70	A92019/64	A92119/64
	7.60	0.2992	37	79	A9207.6	A9217.6
	7.70	0.3031	37	79	A9207.7	A9217.7
	7.80	0.3071	37	79	A9207.8	A9217.8
5/16	7.90	0.3110	37	79	A9207.9	A9217.9
	7.94	0.3126	41	71	A9205/16	A9215/16
	8.00	0.3150	37	79	A9208.0	A9218.0
	8.10	0.3189	37	79	A9208.1	A9218.1

d_1 $\varnothing h_8$ Inch	d_1 $\varnothing h_8$ mm	d_1 decimal Inch	l_2 mm	l_1 mm	A920	A921
	8.20	0.3228	37	79	A9208.2	A9218.2
	8.30	0.3268	37	79	A9208.3	A9218.3
21/64	8.33	0.3280	43	75	A92021/64	A92121/64
	8.40	0.3307	37	79	A9208.4	A9218.4
	8.50	0.3346	37	79	A9208.5	A9218.5
	8.60	0.3386	40	84	A9208.6	A9218.6
	8.70	0.3425	40	84	A9208.7	A9218.7
11/32	8.73	0.3437	43	76	A92011/32	A92111/32
	8.80	0.3465	40	84	A9208.8	A9218.8
	8.90	0.3504	40	84	A9208.9	A9218.9
	9.00	0.3543	40	84	A9209.0	A9219.0
	9.10	0.3583	40	84	A9209.1	A9219.1
23/64	9.13	0.3594	44	78	A92023/64	A92123/64
	9.20	0.3622	40	84	A9209.2	A9219.2
	9.30	0.3661	40	84	A9209.3	A9219.3
	9.40	0.3701	40	84	A9209.4	A9219.4
	9.50	0.3740	40	84	A9209.5	A9219.5
3/8	9.52	0.3748	46	79	A9203/8	A9213/8
	9.60	0.3780	43	89	A9209.6	A9219.6
	9.70	0.3819	43	89	A9209.7	A9219.7
	9.80	0.3858	43	89	A9209.8	A9219.8
	9.90	0.3898	43	89	A9209.9	A9219.9
25/64	9.92	0.3906	48	83	A92025/64	A92125/64
	10.00	0.3937	43	89	A92010.0	A92110.0
	10.20	0.4016	43	89	A92010.2	A92110.2
	10.30	0.4055	43	89	A92010.3	A92110.3
13/32	10.32	0.4063	49	84	A92013/32	A92113/32
	10.40	0.4094	43	89	A92010.4	A92110.4
	10.50	0.4134	43	89	A92010.5	A92110.5
27/64	10.72	0.4220	51	86	A92027/64	A92127/64
	10.75	0.4232	47	95	A92010.75	A92110.75
	10.80	0.4252	47	95	A92010.8	A92110.8
	11.00	0.4331	47	95	A92011.0	A92111.0
7/16	11.11	0.4374	52	87	A9207/16	A9217/16
	11.20	0.4409	47	95	A92011.2	A92111.2
	11.25	0.4429	47	95	A92011.25	A92111.25
	11.50	0.4528	47	95	A92011.5	A92111.5
29/64	11.51	0.4531	54	90	A92029/64	A92129/64
	11.80	0.4646	47	95	A92011.8	A92111.8
15/32	11.91	0.4689	54	92	A92015/32	A92115/32
	12.00	0.4724	51	102	A92012.0	A92112.0
	12.20	0.4803	51	102	A92012.2	A92112.2
31/64	12.30	0.4843	56	94	A92031/64	A92131/64
	12.50	0.4921	51	102	A92012.5	A92112.5
1/2	12.70	0.5000	57	95	A9201/2	A9211/2
	12.75	0.5020	51	102	A92012.75	A92112.75
	12.80	0.5039	51	102	A92012.8	A92112.8
	12.90	0.5079	51	102	A92012.9	
	13.00	0.5118	51	102	A92013.0	A92113.0
33/64	13.10	0.5157	60	98	A92033/64	A92133/64
	13.50	0.5315	54	107	A92013.5	A92113.5
35/64	13.89	0.5469	64	102	A92035/64	A92135/64
	14.00	0.5512	54	107	A92014.0	A92114.0
9/16	14.29	0.5626	64	102	A9209/16	A9219/16
	14.50	0.5709	56	111	A92014.5	A92114.5
37/64	14.68	0.5780	67	105	A92037/64	A92137/64
	14.75	0.5807	56	111	A92014.75	A92114.75
	15.00	0.5906	56	111	A92015.0	A92115.0
19/32	15.08	0.5937	67	105	A92019/32	A92119/32
39/64	15.48	0.6094	70	108	A92039/64	A92139/64
	15.50	0.6102	58	115	A92015.5	A92115.5
5/8	15.88	0.6252	70	108	A9205/8	A9215/8
	16.00	0.6299	58	115	A92016.0	A92116.0
41/64	16.27	0.6406	73	114	A92041/64	
	16.50	0.6496	60	119	A92016.5	
21/32	16.67	0.6563	73	114	A92021/32	
	16.75	0.6594	60	119	A92016.75	

d_1 $\varnothing h_8$ Inch	d_1 $\varnothing h_8$ mm	d_1 decimal Inch	l_2 mm	l_1 mm	A920	A921
	17.00	0.6693	60	119	A92017.0	
43/64	17.07	0.6720	73	117	A92043/64	
11/16	17.46	0.6874	73	117	A92011/16	
	17.50	0.6890	62	123	A92017.5	
45/64	17.86	0.7031	76	121	A92045/64	
	18.00	0.7087	62	123	A92018.0	
23/32	18.26	0.7189	76	121	A92023/32	
	18.50	0.7283	64	127	A92018.5	
47/64	18.65	0.7343	79	127	A92047/64	
	19.00	0.7480	64	127	A92019.0	
3/4	19.05	0.7500	79	127	A9203/4	
49/64	19.45	0.7657	83	130	A92049/64	
	19.50	0.7677	66	131	A92019.5	
25/32	19.84	0.7811	83	130	A92025/32	
	20.00	0.7874	66	131	A92020.0	



A002

- 002 普通长度钻头
- 002 Broca Serie Curta
- 002 Broca , serie corta
- 002 Jobber Drill

小于 2.0 mm 为光亮表面, 2.0 mm 及以上为端部涂 TiN 的分离式钻尖
 Brilhante Abaixo de 2.0mm. Ponta de TiN e afiação em Cruz para 2.0mm e acima
 Brillante por debajo de 2.0mm, Punta de TiN y rectificado de la punta a partir 2.0mm
 Bright below 2.0mm, TiN Tipped and Split Point 2.0mm and above

A002S

- 002 通用型钻头
- Broca 002 em embalagem individual
- Broca 002, serie corta en blister
- 002 Jobber Drill - Pouch Pack

顶端涂 TiN 的分离式钻尖
 Ponta de TiN - Afiação em Cruz
 Punta de TiN y rectificado de la punta
 TiN Tipped and Split Point

A002: A002S	■	1.1	1.2	1.3	1.4	3.1	3.2	7.1	7.2	8.1	8.2								
	•	1.5	1.6	2.1	2.2	2.3	3.3	3.4	4.1	4.2	4.3	5.1	5.2	5.3	6.1	6.2	6.3	6.4	7.3
		7.4	8.3	9.1															

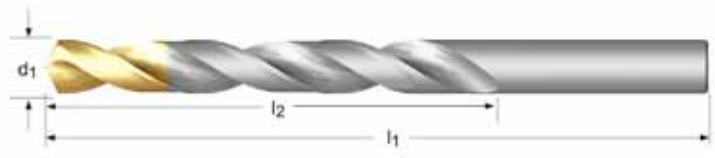

d_1 $\varnothing h_8$ Inch	d_1 $\varnothing h_8$ mm	d_1 decimal Inch	l_2 mm	l_1 mm	A002	A002S
	1.00	0.0394	12	34	A0021.0	
	1.10	0.0433	14	36	A0021.1	
3/64	1.19	0.0469	16	38	A0023/64	
	1.20	0.0472	16	38	A0021.2	
	1.30	0.0512	16	38	A0021.3	
	1.40	0.0551	18	40	A0021.4	
	1.50	0.0591	18	40	A0021.5	
1/16	1.59	0.0626	20	43	A0021/16	
	1.60	0.0630	20	43	A0021.6	
	1.70	0.0669	20	43	A0021.7	
	1.80	0.0709	22	46	A0021.8	
	1.90	0.0748	22	46	A0021.9	

d_1 \varnothing_{h_8} Inch	d_1 \varnothing_{h_8} mm	d_1 decimal Inch	l_2 mm	l_1 mm	A002	A002S
5/64	1.98	0.0780	24	49	A0025/64	
	2.00	0.0787	24	49	A0022.0	A002S2.0 ¹⁾
	2.10	0.0827	24	49	A0022.1	
	2.20	0.0866	27	53	A0022.2	
3/32	2.30	0.0906	27	53	A0022.3	
	2.38	0.0937	30	57	A0023/32	
	2.40	0.0945	30	57	A0022.4	
	2.50	0.0984	30	57	A0022.5	A002S2.5 ¹⁾
7/64	2.60	0.1024	30	57	A0022.6	
	2.70	0.1063	33	61	A0022.7	
	2.78	0.1094	33	61	A0027/64	
	2.80	0.1102	33	61	A0022.8	
1/8	2.90	0.1142	33	61	A0022.9	
	3.00	0.1181	33	61	A0023.0	A002S3.0 ¹⁾
	3.10	0.1220	36	65	A0023.1	
	3.18	0.1252	36	65	A0021/8	A002S1/8 ¹⁾
9/64	3.20	0.1260	36	65	A0023.2	A002S3.2 ¹⁾
	3.25	0.1280	36	65	A0023.25	
	3.30	0.1299	36	65	A0023.3	A002S3.3 ¹⁾
	3.40	0.1339	39	70	A0023.4	
5/32	3.50	0.1378	39	70	A0023.5	A002S3.5 ¹⁾
	3.57	0.1406	39	70	A0029/64	
	3.60	0.1417	39	70	A0023.6	
	3.70	0.1457	39	70	A0023.7	
11/64	3.80	0.1496	43	75	A0023.8	
	3.90	0.1535	43	75	A0023.9	
	3.97	0.1563	43	75	A0025/32	A002S5/32 ¹⁾
	4.00	0.1575	43	75	A0024.0	A002S4.0 ¹⁾
3/16	4.10	0.1614	43	75	A0024.1	A002S4.1 ¹⁾
	4.20	0.1654	43	75	A0024.2	A002S4.2 ¹⁾
	4.30	0.1693	47	80	A0024.3	
	4.37	0.1720	47	80	A00211/64	
7/32	4.40	0.1732	47	80	A0024.4	
	4.50	0.1772	47	80	A0024.5	A002S4.5 ¹⁾
	4.60	0.1811	47	80	A0024.6	
	4.70	0.1850	47	80	A0024.7	
13/64	4.76	0.1874	52	86	A0023/16	A002S3/16 ¹⁾
	4.80	0.1890	52	86	A0024.8	
	4.90	0.1929	52	86	A0024.9	
	5.00	0.1969	52	86	A0025.0	A002S5.0 ¹⁾
15/64	5.10	0.2008	52	86	A0025.1	
	5.16	0.2031	52	86	A00213/64	A002S13/64
	5.20	0.2047	52	86	A0025.2	
	5.30	0.2087	52	86	A0025.3	
7/16	5.40	0.2126	57	93	A0025.4	
	5.50	0.2165	57	93	A0025.5	A002S5.5
	5.56	0.2189	57	93	A0027/32	A002S7/32
	5.60	0.2205	57	93	A0025.6	
1/4	5.70	0.2244	57	93	A0025.7	
	5.80	0.2283	57	93	A0025.8	
	5.90	0.2323	57	93	A0025.9	
	5.95	0.2343	57	93	A00215/64	
3/8	6.00	0.2362	57	93	A0026.0	A002S6.0
	6.10	0.2402	63	101	A0026.1	
	6.20	0.2441	63	101	A0026.2	
	6.30	0.2480	63	101	A0026.3	
5/8	6.35	0.2500	63	101	A0021/4	A002S1/4
	6.40	0.2520	63	101	A0026.4	
	6.50	0.2559	63	101	A0026.5	A002S6.5
	6.60	0.2598	63	101	A0026.6	
3/4	6.70	0.2638	63	101	A0026.7	
	6.75	0.2657	69	109	A00217/64	A002S17/64
	6.80	0.2677	69	109	A0026.8	A002S6.8
	6.90	0.2717	69	109	A0026.9	
7/8	7.00	0.2756	69	109	A0027.0	A002S7.0
	7.10	0.2795	69	109	A0027.1	

¹⁾ 2支一包 / Duas por embalagem/ 2 por blister/ sold in packs of two

d_1 $\varnothing h_8$ Inch	d_1 $\varnothing h_8$ mm	d_1 decimal Inch	l_2 mm	l_1 mm	A002	A002S
9/32	7.14	0.2811	69	109	A0029/32	
	7.20	0.2835	69	109	A0027.2	
	7.30	0.2874	69	109	A0027.3	
	7.40	0.2913	69	109	A0027.4	
	7.50	0.2953	69	109	A0027.5	A002S7.5
19/64	7.54	0.2969	75	117	A00219/64	
	7.60	0.2992	75	117	A0027.6	
	7.70	0.3031	75	117	A0027.7	
	7.80	0.3071	75	117	A0027.8	
	7.90	0.3110	75	117	A0027.9	
5/16	7.94	0.3126	75	117	A0025/16	A002S5/16
	8.00	0.3150	75	117	A0028.0	A002S8.0
	8.10	0.3189	75	117	A0028.1	
	8.20	0.3228	75	117	A0028.2	A002S8.2
	8.30	0.3268	75	117	A0028.3	
21/64	8.33	0.3280	75	117	A00221/64	
	8.40	0.3307	75	117	A0028.4	
	8.50	0.3346	75	117	A0028.5	A002S8.5
	8.60	0.3386	81	125	A0028.6	
	8.70	0.3425	81	125	A0028.7	
11/32	8.73	0.3437	81	125	A00211/32	
	8.80	0.3465	81	125	A0028.8	
	8.90	0.3504	81	125	A0028.9	
	9.00	0.3543	81	125	A0029.0	A002S9.0
	9.10	0.3583	81	125	A0029.1	
23/64	9.13	0.3594	81	125	A00223/64	
	9.20	0.3622	81	125	A0029.2	
	9.30	0.3661	81	125	A0029.3	
	9.40	0.3701	81	125	A0029.4	
	9.50	0.3740	81	125	A0029.5	A002S9.5
3/8	9.52	0.3748	87	133	A0023/8	A002S3/8
	9.60	0.3780	87	133	A0029.6	
	9.70	0.3819	87	133	A0029.7	
	9.80	0.3858	87	133	A0029.8	
	9.90	0.3898	87	133	A0029.9	
25/64	9.92	0.3906	87	133	A00225/64	
	10.00	0.3937	87	133	A00210.0	A002S10.0
	10.10	0.3976	87	133	A00210.1	
	10.20	0.4016	87	133	A00210.2	A002S10.2
	10.30	0.4055	87	133	A00210.3	
13/32	10.32	0.4063	87	133	A00213/32	
	10.40	0.4094	87	133	A00210.4	
	10.50	0.4134	87	133	A00210.5	A002S10.5
	10.60	0.4173	87	133	A00210.6	
	10.70	0.4213	94	142	A00210.7	
27/64	10.72	0.4220	94	142	A00227/64	
	10.80	0.4252	94	142	A00210.8	
	10.90	0.4291	94	142	A00210.9	
	11.00	0.4331	94	142	A00211.0	A002S11.0
	11.10	0.4370	94	142	A00211.1	
7/16	11.11	0.4374	94	142	A0027/16	
	11.20	0.4409	94	142	A00211.2	
	11.30	0.4449	94	142	A00211.3	
	11.40	0.4488	94	142	A00211.4	
	11.50	0.4528	94	142	A00211.5	A002S11.5
29/64	11.51	0.4531	94	142	A00229/64	
	11.60	0.4567	94	142	A00211.6	
	11.70	0.4606	94	142	A00211.7	
	11.80	0.4646	94	142	A00211.8	
	11.90	0.4685	101	151	A00211.9	
15/32	11.91	0.4689	101	151	A00215/32	
	12.00	0.4724	101	151	A00212.0	A002S12.0
	12.10	0.4764	101	151	A00212.1	
	12.20	0.4803	101	151	A00212.2	
	12.30	0.4843	101	151	A00212.3	
31/64	12.30	0.4843	101	151	A00231/64	
	12.40	0.4882	101	151	A00212.4	

d_1 $\varnothing h_8$ Inch	d_1 $\varnothing h_8$ mm	d_1 decimal Inch	l_2 mm	l_1 mm	A002	A002S
	12.50	0.4921	101	151	A00212.5	A002S12.5
	12.60	0.4961	101	151	A00212.6	
	12.70	0.5000	101	151	A00212.7	
1/2	12.70	0.5000	101	151	A0021/2	A002S1/2
	12.80	0.5039	101	151	A00212.8	
	12.90	0.5079	101	151	A00212.9	
	13.00	0.5118	101	151	A00213.0	A002S13.0
33/64	13.10	0.5157	101	151	A00233/64	
	13.10	0.5157	101	151	A00213.1	
	13.20	0.5197	101	151	A00213.2	
	13.25	0.5217	108	160	A00213.25	
	13.30	0.5236	108	160	A00213.3	
	13.40	0.5276	108	160	A00213.4	
17/32	13.49	0.5311	108	160	A00217/32	
	13.50	0.5315	108	160	A00213.5	
	13.60	0.5354	108	160	A00213.6	
	13.70	0.5394	108	160	A00213.7	
	13.75	0.5413	108	160	A00213.75	
	13.80	0.5433	108	160	A00213.8	
35/64	13.89	0.5469	108	160	A00235/64	
	13.90	0.5472	108	160	A00213.9	
	14.00	0.5512	108	160	A00214.0	
	14.25	0.5610	114	169	A00214.25	
9/16	14.29	0.5626	114	169	A0029/16	
	14.50	0.5709	114	169	A00214.5	
37/64	14.68	0.5780	114	169	A00237/64	
	14.75	0.5807	114	169	A00214.75	
	15.00	0.5906	114	169	A00215.0	
19/32	15.08	0.5937	120	178	A00219/32	
	15.25	0.6004	120	178	A00215.25	
39/64	15.48	0.6094	120	178	A00239/64	
	15.50	0.6102	120	178	A00215.5	
	15.75	0.6201	120	178	A00215.75	
5/8	15.88	0.6252	120	178	A0025/8	
	16.00	0.6299	120	178	A00216.0	

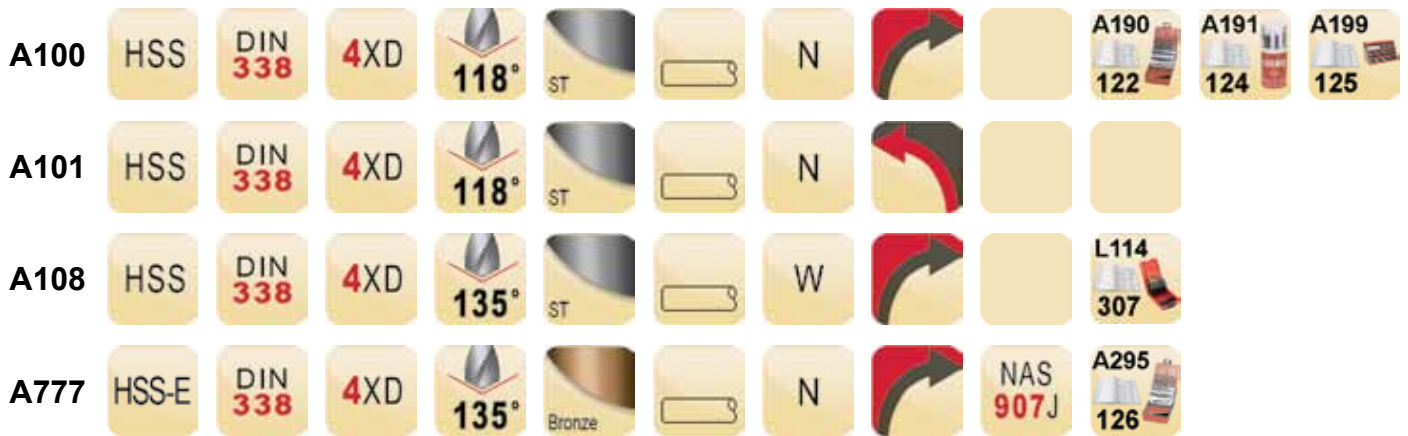

A100

- 普通长度钻头
- Broca Série Curta
- Broca , serie corta
- Jobber Drill

小于1.0 mm, 3/64" 和 N60 为光亮
Brilhante abaixo de 1,0mm, 3/64", N60
Brillante por debajo de 1,0 mm, 3/64".N60
Bright below 1.0mm, 3/64", N60

A101

- 普通长度钻头 - 左旋
- Broca Série Curta - Esquerda
- Broca , serie corta - LH
- Jobber Drill - LH

小于3.0 mm 为光亮
Brilhante abaixo de 3.0mm
Brillante por debajo de 3,0 mm
Bright below 3.0mm

A108

- 普通长度钻头 分离式钻尖
- Broca Série Curta Afição em Cruz
- Broca , serie corta Punta afilada
- Jobber Drill Split Point

1.6 mm, 1/16" 及以上为分离式钻尖
Afição em cruz 1,6mm, 1/16" e acima
Afilado en cruz desde 1,6mm, 1/16"
Split Point 1.6mm, 1/16" and above

A777

- 普通长度钻头
- Broca Série Curta
- Broca , serie corta
- Jobber Drill

不大于 1.4 mm 为 4 后面钻尖
Ponta 4 faces até 1,4mm
Punta de 4 caras hasta 1,4 mm
4 Facet Point up to 1.4mm.

A100; A101	▪	1.1	1.2	1.3	1.4	3.1	3.2													
	•	1.5	1.6	2.1	2.2	2.3	3.3	3.4	4.1	4.2	4.3	5.1	5.2	5.3	6.1	6.2	6.3	6.4	7.1	
		7.2	7.3	7.4	8.1	8.2	8.3	9.1												
A108	▪	2.2	2.3	4.1	4.2															
	•	1.1	1.2	1.3	1.4	1.5	1.6	2.1	3.1	3.2	3.3	3.4	4.3	5.1	5.2	5.3	6.1	6.2	6.3	
		6.4	7.1	7.2	7.3	7.4	8.1	8.2	8.3	9.1										
A777	▪	1.5	1.6	3.4	4.1	4.2	4.3	5.2												
	•	1.1	1.2	1.3	1.4	2.1	2.2	2.3	3.1	3.2	3.3	5.1	5.3	6.1	6.2	6.3	6.4	7.1	7.2	
		7.3	7.4	9.1																

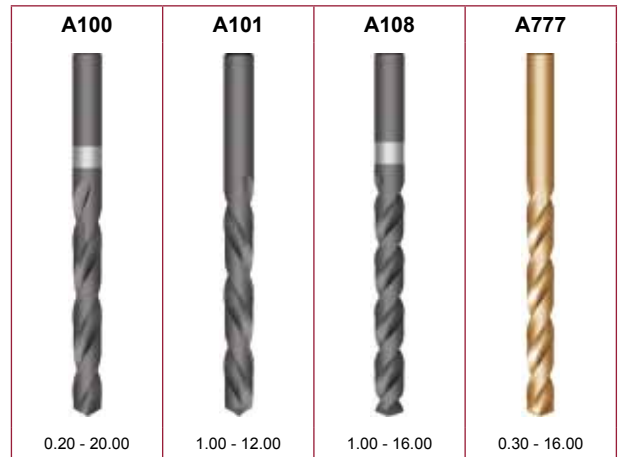

d_1 $\varnothing h_8$ "/Nr./letter	d_1 $\varnothing h_8$ mm	d_1 decimal Inch	l_2 mm	l_1 mm	A100	A101	A108	A777
	0.20	0.0079	2.5	19	A100.2			
	0.25	0.0098	3	19	A100.25			
	0.30	0.0118	3	19	A100.3			A777.3
	0.32	0.0126	4	19	A100.32			
80	0.34	0.0134	4	19	A100N80			
	0.35	0.0138	4	19	A100.35			A777.35
79	0.37	0.0146	4	19	A100N79			
	0.38	0.0150	4	19	A100.38			
1/64	0.40	0.0157	5	20	A1001/64			
	0.40	0.0157	5	20	A100.4			A777.4
78	0.41	0.0161	5	20	A100N78			
	0.42	0.0165	5	20	A100.42			
	0.45	0.0177	5	20	A100.45			A777.45
77	0.46	0.0181	5	20	A100N77			
	0.48	0.0189	5	20	A100.48			
	0.50	0.0197	6	22	A100.5			A777.5
76	0.51	0.0201	6	22	A100N76			
	0.52	0.0205	6	22	A100.52			
75	0.53	0.0209	6	22	A100N75			
	0.55	0.0217	7	24	A100.55			A777.55
74	0.57	0.0224	7	24	A100N74			
	0.58	0.0228	7	24	A100.58			
	0.60	0.0236	7	24	A100.6			A777.6
73	0.61	0.0240	8	26	A100N73			
	0.62	0.0244	8	26	A100.62			
72	0.64	0.0252	8	26	A100N72			
	0.65	0.0256	8	26	A100.65			A777.65
71	0.66	0.0260	8	26	A100N71			
	0.68	0.0268	9	28	A100.68			
	0.70	0.0276	9	28	A100.7			A777.7
70	0.71	0.0280	9	28	A100N70			
	0.72	0.0283	9	28	A100.72			
69	0.74	0.0291	9	28	A100N69			
	0.75	0.0295	9	28	A100.75			
68	0.79	0.0311	10	30	A100N68			
	0.78	0.0307	10	30	A100.78			
1/32	0.79	0.0311	10	30	A1001/32			
	0.80	0.0315	10	30	A100.8			A777.8
67	0.81	0.0319	10	30	A100N67			
	0.82	0.0323	10	30	A100.82			
66	0.84	0.0331	10	30	A100N66			
	0.85	0.0335	10	30	A100.85			
	0.88	0.0346	11	32	A100.88			
65	0.89	0.0350	11	32	A100N65			
	0.90	0.0354	11	32	A100.9			A777.9
64	0.91	0.0358	11	32	A100N64			
	0.92	0.0362	11	32	A100.92			
63	0.94	0.0370	11	32	A100N63			
	0.95	0.0374	11	32	A100.95			A777.95
62	0.97	0.0382	12	34	A100N62			
	0.98	0.0386	12	34	A100.98			
61	0.99	0.0390	12	34	A100N61			

d_1 $\varnothing h_8$ "/Nr./letter	d_1 $\varnothing h_8$ mm	d_1 decimal Inch	l_2 mm	l_1 mm	A100	A101	A108	A777
	1.00	0.0394	12	34	A1001.0	A1011.0	A1081.0	A7771.0
60	1.02	0.0402	12	34	A100N60			
59	1.04	0.0409	12	34	A100N59			
	1.05	0.0413	12	34	A1001.05			
58	1.07	0.0421	14	36	A100N58			
57	1.09	0.0429	14	36	A100N57			
	1.10	0.0433	14	36	A1001.1	A1011.1	A1081.1	A7771.1
	1.15	0.0453	14	36	A1001.15			
56	1.18	0.0465	14	36	A100N56			
3/64	1.19	0.0469	16	38	A1003/64			
	1.20	0.0472	16	38	A1001.2	A1011.2	A1081.2	A7771.2
	1.25	0.0492	16	38	A1001.25	A1011.25		
	1.30	0.0512	16	38	A1001.3	A1011.3	A1081.3	A7771.3
55	1.32	0.0520	16	38	A100N55			
	1.35	0.0531	18	40	A1001.35			
	1.40	0.0551	18	40	A1001.4	A1011.4	A1081.4	A7771.4
54	1.40	0.0551	18	40	A100N54			
	1.45	0.0571	18	40	A1001.45			
	1.50	0.0591	18	40	A1001.5	A1011.5	A1081.5	A7771.5
53	1.51	0.0594	20	43	A100N53			
	1.55	0.0610	20	43	A1001.55			
1/16	1.59	0.0626	20	43	A1001/16		A1081/16	A7771/16
	1.60	0.0630	20	43	A1001.6	A1011.6	A1081.6	A7771.6
52	1.61	0.0634	20	43	A100N52			
	1.65	0.0650	20	43	A1001.65			
	1.70	0.0669	20	43	A1001.7	A1011.7	A1081.7	A7771.7
51	1.70	0.0669	22	46	A100N51			
	1.75	0.0689	22	46	A1001.75			
50	1.78	0.0701	22	46	A100N50			
	1.80	0.0709	22	46	A1001.8	A1011.8	A1081.8	A7771.8
	1.85	0.0728	22	46	A1001.85			
49	1.85	0.0728	22	46	A100N49			
	1.90	0.0748	22	46	A1001.9	A1011.9	A1081.9	A7771.9
48	1.93	0.0760	24	49	A100N48			
	1.95	0.0768	24	49	A1001.95			
5/64	1.98	0.0780	24	49	A1005/64		A1085/64	A7775/64
47	1.99	0.0783	24	49	A100N47			
	2.00	0.0787	24	49	A1002.0	A1012.0	A1082.0	A7772.0
	2.05	0.0807	24	49	A1002.05			
46	2.06	0.0811	24	49	A100N46			
45	2.08	0.0819	24	49	A100N45			
	2.10	0.0827	24	49	A1002.1	A1012.1	A1082.1	A7772.1
	2.15	0.0846	27	53	A1002.15			
44	2.18	0.0858	27	53	A100N44			
	2.20	0.0866	27	53	A1002.2	A1012.2	A1082.2	A7772.2
	2.25	0.0886	27	53	A1002.25			
43	2.26	0.0890	27	53	A100N43			
	2.30	0.0906	27	53	A1002.3	A1012.3	A1082.3	A7772.3
	2.35	0.0925	27	53	A1002.35			
42	2.38	0.0937	30	57	A100N42			
3/32	2.38	0.0937	30	57	A1003/32		A1083/32	A7773/32
	2.40	0.0945	30	57	A1002.4	A1012.4	A1082.4	A7772.4
41	2.44	0.0961	30	57	A100N41			
	2.45	0.0965	30	57	A1002.45			
40	2.49	0.0980	30	57	A100N40			
	2.50	0.0984	30	57	A1002.5	A1012.5	A1082.5	A7772.5
39	2.53	0.0996	30	57	A100N39			
	2.55	0.1004	30	57	A1002.55			
38	2.58	0.1016	30	57	A100N38			
	2.60	0.1024	30	57	A1002.6	A1012.6	A1082.6	A7772.6
37	2.64	0.1039	30	57	A100N37			
	2.65	0.1043	30	57	A1002.65			
	2.70	0.1063	33	61	A1002.7	A1012.7	A1082.7	A7772.7
36	2.71	0.1067	33	61	A100N36			
	2.75	0.1083	33	61	A1002.75			
7/64	2.78	0.1094	33	61	A1007/64		A1087/64	A7777/64
35	2.79	0.1098	33	61	A100N35			
	2.80	0.1102	33	61	A1002.8	A1012.8	A1082.8	A7772.8
34	2.82	0.1110	33	61	A100N34			
	2.85	0.1122	33	61	A1002.85			
33	2.87	0.1130	33	61	A100N33			
	2.90	0.1142	33	61	A1002.9	A1012.9	A1082.9	A7772.9

d ₁ Øh ₈ "/Nr./letter	d ₁ Øh ₈ mm	d ₁ decimal Inch	l ₂ mm	l ₁ mm	A100	A101	A108	A777
	2.95	0.1161	33	61	A1002.95			
32	2.95	0.1161	33	61	A100N32			
	3.00	0.1181	33	61	A1003.0	A1013.0	A1083.0	A7773.0
31	3.05	0.1201	36	65	A100N31			
	3.10	0.1220	36	65	A1003.1		A1083.1	A7773.1
	3.15	0.1240	36	65	A1003.15			
1/8	3.18	0.1252	36	65	A1001/8		A1081/8	A7771/8
	3.20	0.1260	36	65	A1003.2	A1013.2	A1083.2	A7773.2
	3.25	0.1280	36	65	A1003.25			
30	3.26	0.1283	36	65	A100N30			
	3.30	0.1299	36	65	A1003.3	A1013.3	A1083.3	A7773.3
	3.40	0.1339	39	70	A1003.4		A1083.4	A7773.4
29	3.45	0.1358	39	70	A100N29			
	3.50	0.1378	39	70	A1003.5	A1013.5	A1083.5	A7773.5
28	3.57	0.1406	39	70	A100N28			
9/64	3.57	0.1406	39	70	A1009/64		A1089/64	A7779/64
	3.60	0.1417	39	70	A1003.6		A1083.6	A7773.6
27	3.66	0.1441	39	70	A100N27			
	3.70	0.1457	39	70	A1003.7		A1083.7	A7773.7
26	3.73	0.1469	39	70	A100N26			
	3.75	0.1476	39	70	A1003.75			
	3.80	0.1496	43	75	A1003.8	A1013.8	A1083.8	A7773.8
25	3.80	0.1496	43	75	A100N25			
24	3.86	0.1520	43	75	A100N24			
	3.90	0.1535	43	75	A1003.9		A1083.9	A7773.9
23	3.91	0.1539	43	75	A100N23			
5/32	3.97	0.1563	43	75	A1005/32		A1085/32	A7775/32
22	3.99	0.1571	43	75	A100N22			
	4.00	0.1575	43	75	A1004.0	A1014.0	A1084.0	A7774.0
21	4.04	0.1591	43	75	A100N21			
20	4.09	0.1610	43	75	A100N20			
	4.10	0.1614	43	75	A1004.1		A1084.1	A7774.1
	4.20	0.1654	43	75	A1004.2	A1014.2	A1084.2	A7774.2
19	4.22	0.1661	43	75	A100N19			
	4.25	0.1673	43	75	A1004.25			
	4.30	0.1693	47	80	A1004.3		A1084.3	A7774.3
18	4.31	0.1697	47	80	A100N18			
11/64	4.37	0.1720	47	80	A10011/64		A10811/64	A77711/64
17	4.39	0.1728	47	80	A100N17			
	4.40	0.1732	47	80	A1004.4		A1084.4	A7774.4
	4.50	0.1772	47	80	A1004.5	A1014.5	A1084.5	A7774.5
16	4.50	0.1772	47	80	A100N16			
15	4.57	0.1799	47	80	A100N15			
	4.60	0.1811	47	80	A1004.6		A1084.6	A7774.6
14	4.62	0.1819	47	80	A100N14			
	4.70	0.1850	47	80	A1004.7		A1084.7	A7774.7
13	4.70	0.1850	47	80	A100N13			
	4.75	0.1870	47	80	A1004.75			
3/16	4.76	0.1874	52	86	A1003/16		A1083/16	A7773/16
	4.80	0.1890	52	86	A1004.8	A1014.8	A1084.8	A7774.8
12	4.80	0.1890	52	86	A100N12			
11	4.85	0.1909	52	86	A100N11			
	4.90	0.1929	52	86	A1004.9		A1084.9	A7774.9
10	4.92	0.1937	52	86	A100N10		A108N10	
9	4.98	0.1961	52	86	A100N9			
	5.00	0.1969	52	86	A1005.0	A1015.0	A1085.0	A7775.0
8	5.06	0.1992	52	86	A100N8			
	5.10	0.2008	52	86	A1005.1	A1015.1	A1085.1	A7775.1
7	5.11	0.2012	52	86	A100N7			
13/64	5.16	0.2031	52	86	A10013/64		A10813/64	A77713/64
6	5.18	0.2039	52	86	A100N6			
	5.20	0.2047	52	86	A1005.2	A1015.2	A1085.2	A7775.2
5	5.22	0.2055	52	86	A100N5			
	5.25	0.2067	52	86	A1005.25			
	5.30	0.2087	52	86	A1005.3		A1085.3	A7775.3
4	5.31	0.2091	57	93	A100N4			
	5.40	0.2126	57	93	A1005.4		A1085.4	A7775.4
3	5.41	0.2130	57	93	A100N3			
	5.50	0.2165	57	93	A1005.5	A1015.5	A1085.5	A7775.5
7/32	5.56	0.2189	57	93	A1007/32		A1087/32	A7777/32
	5.60	0.2205	57	93	A1005.6		A1085.6	A7775.6
2	5.61	0.2209	57	93	A100N2			

d ₁ Øh ₈ "/Nr./letter	d ₁ Øh ₈ mm	d ₁ decimal Inch	l ₂ mm	l ₁ mm	A100	A101	A108	A777
	5.70	0.2244	57	93	A1005.7		A1085.7	A7775.7
	5.75	0.2264	57	93	A1005.75			
1	5.79	0.2280	57	93	A100N1			
	5.80	0.2283	57	93	A1005.8		A1085.8	A7775.8
	5.90	0.2323	57	93	A1005.9		A1085.9	A7775.9
A	5.94	0.2339	57	93	A100A			
15/64	5.95	0.2343	57	93	A10015/64		A10815/64	A77715/64
	6.00	0.2362	57	93	A1006.0	A1016.0	A1086.0	A7776.0
B	6.03	0.2374	63	101	A100B			
	6.10	0.2402	63	101	A1006.1		A1086.1	A7776.1
C	6.15	0.2421	63	101	A100C			
	6.20	0.2441	63	101	A1006.2		A1086.2	A7776.2
	6.25	0.2461	63	101	A1006.25			
D	6.25	0.2461	63	101	A100D			
	6.30	0.2480	63	101	A1006.3		A1086.3	A7776.3
1/4	6.35	0.2500	63	101	A1001/4		A1081/4	A7771/4
E	6.35	0.2500	63	101	A100E			
	6.40	0.2520	63	101	A1006.4		A1086.4	A7776.4
	6.50	0.2559	63	101	A1006.5	A1016.5	A1086.5	A7776.5
F	6.53	0.2571	63	101	A100F			
	6.60	0.2598	63	101	A1006.6		A1086.6	A7776.6
G	6.63	0.2610	63	101	A100G			
	6.70	0.2638	63	101	A1006.7		A1086.7	A7776.7
17/64	6.75	0.2657	69	109	A10017/64		A10817/64	A77717/64
	6.75	0.2657	69	109	A1006.75			
H	6.76	0.2661	69	109	A100H			
	6.80	0.2677	69	109	A1006.8		A1086.8	A7776.8
	6.90	0.2717	69	109	A1006.9		A1086.9	A7776.9
I	6.91	0.2720	69	109	A100I			
	7.00	0.2756	69	109	A1007.0	A1017.0	A1087.0	A7777.0
J	7.04	0.2772	69	109	A100J			
	7.10	0.2795	69	109	A1007.1		A1087.1	A7777.1
K	7.14	0.2811	69	109	A100K			
9/32	7.14	0.2811	69	109	A1009/32		A1089/32	A7779/32
	7.20	0.2835	69	109	A1007.2		A1087.2	A7777.2
	7.25	0.2854	69	109	A1007.25			
	7.30	0.2874	69	109	A1007.3		A1087.3	A7777.3
L	7.37	0.2902	69	109	A100L			
	7.40	0.2913	69	109	A1007.4		A1087.4	A7777.4
M	7.49	0.2949	69	109	A100M			
	7.50	0.2953	69	109	A1007.5	A1017.5	A1087.5	A7777.5
19/64	7.54	0.2969	75	117	A10019/64		A10819/64	A77719/64
	7.60	0.2992	75	117	A1007.6		A1087.6	A7777.6
N	7.67	0.3020	75	117	A100N			
	7.70	0.3031	75	117	A1007.7		A1087.7	A7777.7
	7.75	0.3051	75	117	A1007.75			
	7.80	0.3071	75	117	A1007.8		A1087.8	A7777.8
	7.90	0.3110	75	117	A1007.9		A1087.9	A7777.9
5/16	7.94	0.3126	75	117	A1005/16		A1085/16	A7775/16
	8.00	0.3150	75	117	A1008.0	A1018.0	A1088.0	A7778.0
O	8.03	0.3161	75	117	A100O			
	8.10	0.3189	75	117	A1008.1		A1088.1	A7778.1
	8.20	0.3228	75	117	A1008.2		A1088.2	A7778.2
P	8.20	0.3228	75	117	A100P			
	8.25	0.3248	75	117	A1008.25			
	8.30	0.3268	75	117	A1008.3		A1088.3	A7778.3
21/64	8.33	0.3280	75	117	A10021/64		A10821/64	A77721/64
	8.40	0.3307	75	117	A1008.4		A1088.4	A7778.4
Q	8.43	0.3319	75	117	A100Q			
	8.50	0.3346	75	117	A1008.5	A1018.5	A1088.5	A7778.5
	8.60	0.3386	81	125	A1008.6		A1088.6	A7778.6
R	8.61	0.3390	81	125	A100R			
	8.70	0.3425	81	125	A1008.7		A1088.7	A7778.7
11/32	8.73	0.3437	81	125	A10011/32		A10811/32	A77711/32
	8.75	0.3445	81	125	A1008.75			
	8.80	0.3465	81	125	A1008.8		A1088.8	A7778.8
S	8.84	0.3480	81	125	A100S			
	8.90	0.3504	81	125	A1008.9		A1088.9	A7778.9
	9.00	0.3543	81	125	A1009.0	A1019.0	A1089.0	A7779.0
T	9.09	0.3579	81	125	A100T			
	9.10	0.3583	81	125	A1009.1		A1089.1	A7779.1
23/64	9.13	0.3594	81	125	A10023/64		A10823/64	A77723/64

d ₁ Øh ₈ "/Nr./letter	d ₁ Øh ₈ mm	d ₁ decimal Inch	l ₂ mm	l ₁ mm	A100	A101	A108	A777
	9.20	0.3622	81	125	A1009.2		A1089.2	A7779.2
	9.25	0.3642	81	125	A1009.25			
	9.30	0.3661	81	125	A1009.3		A1089.3	A7779.3
U	9.35	0.3681	81	125	A100U			
	9.40	0.3701	81	125	A1009.4		A1089.4	A7779.4
	9.50	0.3740	81	125	A1009.5		A1089.5	A7779.5
3/8	9.52	0.3748	87	133	A1003/8		A1083/8	A7773/8
V	9.58	0.3772	87	133	A100V			
	9.60	0.3780	87	133	A1009.6		A1089.6	A7779.6
	9.70	0.3819	87	133	A1009.7		A1089.7	A7779.7
	9.75	0.3839	87	133	A1009.75			
	9.80	0.3858	87	133	A1009.8		A1089.8	A7779.8
W	9.80	0.3858	87	133	A100W			
	9.90	0.3898	87	133	A1009.9		A1089.9	A7779.9
25/64	9.92	0.3906	87	133	A10025/64		A10825/64	A77725/64
	10.00	0.3937	87	133	A10010.0	A10110.0	A10810.0	A77710.0
X	10.08	0.3969	87	133	A100X			
	10.10	0.3976	87	133	A10010.1			A77710.1
	10.20	0.4016	87	133	A10010.2		A10810.2	A77710.2
	10.25	0.4035	87	133	A10010.25			
Y	10.26	0.4039	87	133	A100Y			
	10.30	0.4055	87	133	A10010.3			
13/32	10.32	0.4063	87	133	A10013/32		A10813/32	A77713/32
	10.40	0.4094	87	133	A10010.4			
Z	10.49	0.4130	87	133	A100Z			
	10.50	0.4134	87	133	A10010.5		A10810.5	A77710.5
	10.60	0.4173	87	133	A10010.6			
	10.70	0.4213	94	142	A10010.7			
27/64	10.72	0.4220	94	142	A10027/64		A10827/64	A77727/64
	10.75	0.4232	94	142	A10010.75			
	10.80	0.4252	94	142	A10010.8		A10810.8	A77710.8
	10.90	0.4291	94	142	A10010.9			
	11.00	0.4331	94	142	A10011.0	A10111.0	A10811.0	A77711.0
	11.10	0.4370	94	142	A10011.1			
7/16	11.11	0.4374	94	142	A1007/16		A1087/16	A7777/16
	11.20	0.4409	94	142	A10011.2			A77711.2
	11.25	0.4429	94	142	A10011.25			
	11.30	0.4449	94	142	A10011.3			
	11.40	0.4488	94	142	A10011.4			
	11.50	0.4528	94	142	A10011.5		A10811.5	A77711.5
29/64	11.51	0.4531	94	142	A10029/64		A10829/64	A77729/64
	11.60	0.4567	94	142	A10011.6			
	11.70	0.4606	94	142	A10011.7			
	11.75	0.4626	94	142	A10011.75			
	11.80	0.4646	94	142	A10011.8		A10811.8	A77711.8
	11.90	0.4685	101	151	A10011.9			
15/32	11.91	0.4689	101	151	A10015/32		A10815/32	A77715/32
	12.00	0.4724	101	151	A10012.0	A10112.0	A10812.0	A77712.0
	12.10	0.4764	101	151	A10012.1			
	12.20	0.4803	101	151	A10012.2		A10812.2	A77712.2
	12.25	0.4823	101	151	A10012.25			
	12.30	0.4843	101	151	A10012.3			
31/64	12.30	0.4843	101	151	A10031/64		A10831/64	A77731/64
	12.40	0.4882	101	151	A10012.4			
	12.50	0.4921	101	151	A10012.5		A10812.5	A77712.5
	12.60	0.4961	101	151	A10012.6			
	12.70	0.5000	101	151	A10012.7			
1/2	12.70	0.5000	101	151	A1001/2		A1081/2	A7771/2
	12.75	0.5020	101	151	A10012.75			
	12.80	0.5039	101	151	A10012.8		A10812.8	A77712.8
	12.90	0.5079	101	151	A10012.9		A10812.9	
	13.00	0.5118	101	151	A10013.0		A10813.0	A77713.0
33/64	13.10	0.5157	101	151	A10033/64			
	13.10	0.5157	101	151	A10013.1			
	13.20	0.5197	101	151	A10013.2			
	13.25	0.5217	108	160	A10013.25			
	13.30	0.5236	108	160	A10013.3			
	13.40	0.5276	108	160	A10013.4			
17/32	13.49	0.5311	108	160	A10017/32			
	13.50	0.5315	108	160	A10013.5		A10813.5	A77713.5
	13.60	0.5354	108	160	A10013.6			

d_1 \varnothing_{h_8} "/Nr./letter	d_1 \varnothing_{h_8} mm	d_1 decimal Inch	l_2 mm	l_1 mm	A100	A101	A108	A777
	13.70	0.5394	108	160	A10013.7			
	13.75	0.5413	108	160	A10013.75			
	13.80	0.5433	108	160	A10013.8			
35/64	13.89	0.5469	108	160	A10035/64			
	13.90	0.5472	108	160	A10013.9			
	14.00	0.5512	108	160	A10014.0		A10814.0	A77714.0
	14.25	0.5610	114	169	A10014.25			
9/16	14.29	0.5626	114	169	A1009/16			
	14.50	0.5709	114	169	A10014.5		A10814.5	A77714.5
37/64	14.68	0.5780	114	169	A10037/64			
	14.75	0.5807	114	169	A10014.75			
	15.00	0.5906	114	169	A10015.0		A10815.0	A77715.0
19/32	15.08	0.5937	120	178	A10019/32			
	15.25	0.6004	120	178	A10015.25		A10815.25	
39/64	15.48	0.6094	120	178	A10039/64			
	15.50	0.6102	120	178	A10015.5		A10815.5	A77715.5
	15.75	0.6201	120	178	A10015.75			
5/8	15.88	0.6252	120	178	A1005/8			
	16.00	0.6299	120	178	A10016.0		A10816.0	A77716.0
41/64	16.27	0.6406	125	184	A10041/64			
	16.50	0.6496	125	184	A10016.5			
21/32	16.67	0.6563	125	184	A10021/32			
	17.00	0.6693	125	184	A10017.0			
43/64	17.07	0.6720	130	191	A10043/64			
11/16	17.46	0.6874	130	191	A10011/16			
	17.50	0.6890	130	191	A10017.5			
	18.00	0.7087	130	191	A10018.0			
	18.50	0.7283	135	198	A10018.5			
	19.00	0.7480	135	198	A10019.0			
	19.50	0.7677	140	205	A10019.5			
	20.00	0.7874	140	205	A10020.0			

A170



A170

- 1/2 英寸缩径柄钻头
- Brocas Cilindrica, haste reduzida 1/2"
- Brocas de mango cilindrico, Mango rebajado 1/2"
- 1/2" Reduced Parallel Shank Drill

A170	1.1	1.2	1.3	1.4	1.5	1.6	2.1	2.2	2.3	3.1	3.2	3.3	3.4	4.1	4.2	4.3	5.1	5.2	5.3	6.1	
	6.2	6.3	6.4	7.1	7.2	7.3	7.4	8.1	8.2	8.3	9.1										



d_1 $\varnothing h_8$ Inch	d_1 $\varnothing h_8$ mm	d_1 decimal Inch	l_2 Inch	l_1 Inch	l_2 mm	l_1 mm	A170
	13.00	0.5118					A17013.0
33/64	13.10	0.5157	3.1/8	6"			A17033/64
17/32	13.49	0.5311	3.1/8	6"			A17017/32
	13.50	0.5315			83	156	A17013.5
35/64	13.89	0.5469	3.1/8	6"			A17035/64
	14.00	0.5512			83	156	A17014.0
9/16	14.29	0.5626	3.1/8	6"			A1709/16
	14.50	0.5709			83	156	A17014.5
37/64	14.68	0.5780	3.1/8	6"			A17037/64
	15.00	0.5906			83	156	A17015.0
19/32	15.08	0.5937	3.1/8	6"			A17019/32
39/64	15.48	0.6094	3.1/8	6"			A17039/64
	15.50	0.6102			83	156	A17015.5
5/8	15.88	0.6252	3.1/8	6"			A1705/8
	16.00	0.6299			84	157	A17016.0
41/64	16.27	0.6406	3.1/8	6"			A17041/64
	16.50	0.6496			84	157	A17016.5
21/32	16.67	0.6563	3.1/8	6"			A17021/32
	17.00	0.6693			84	157	A17017.0
43/64	17.07	0.6720	3.1/8	6"			A17043/64
11/16	17.46	0.6874	3.1/8	6"			A17011/16
	17.50	0.6890			84	157	A17017.5
45/64	17.86	0.7031	3.1/8	6"			A17045/64
	18.00	0.7087			84	157	A17018.0
23/32	18.26	0.7189	3.1/8	6"			A17023/32
	18.50	0.7283			84	157	A17018.5
47/64	18.65	0.7343	3.1/8	6"			A17047/64
	19.00	0.7480			84	157	A17019.0
3/4	19.05	0.7500	3.1/8	6"			A1703/4
49/64	19.45	0.7657	3"	6"			A17049/64
	19.50	0.7677			81	158	A17019.5
25/32	19.84	0.7811	3"	6"			A17025/32
	20.00	0.7874			81	158	A17020.0
51/64	20.24	0.7969	3"	6"			A17051/64
13/16	20.64	0.8126	3"	6"			A17013/16
	21.00	0.8268			82	158	A17021.0
53/64	21.03	0.8280	3"	6"			A17053/64
27/32	21.43	0.8437	3"	6"			A17027/32

d_1 $\varnothing h_8$ Inch	d_1 $\varnothing h_8$ mm	d_1 decimal Inch	l_2 Inch	l_1 Inch	l_2 mm	l_1 mm	A170
55/64	21.83	0.8594	3"	6"			A17055/64
	22.00	0.8661			82	158	A17022.0
7/8	22.22	0.8748	3"	6"			A1707/8
57/64	22.62	0.8906	3"	6"			A17057/64
	23.00	0.9055			82	158	A17023.0
29/32	23.02	0.9063	3"	6"			A17029/32
59/64	23.42	0.9220	3"	6"			A17059/64
15/16	23.81	0.9374	3"	6"			A17015/16
	24.00	0.9449			83	159	A17024.0
61/64	24.21	0.9531	3"	6"			A17061/64
31/32	24.61	0.9689	3"	6"			A17031/32
	25.00	0.9843			83	159	A17025.0
63/64	25.00	0.9843	3"	6"			A17063/64
1"	25.40	1.0000	3"	6"			A1701
1.1/32	26.19	1.0311	3"	6"			A1701.1/32
1.1/16	26.99	1.0626	3"	6"			A1701.1/16
1.7/64	28.18	1.1094	3"	6"			A1701.7/64
1.1/8	28.58	1.1252	3"	6"			A1701.1/8
1.9/64	28.97	1.1406	3"	6"			A1701.9/64
1.5/32	29.37	1.1563	3"	6"			A1701.5/32
1.3/16	30.16	1.1874	3"	6"			A1701.3/16
1.7/32	30.96	1.2189	3"	6"			A1701.7/32
1.1/4	31.75	1.2500	3"	6"			A1701.1/4
1.5/16	33.34	1.3126	3"	6"			A1701.5/16
1.3/8	34.93	1.3752	3"	6"			A1701.3/8
1.7/16	36.51	1.4374	3"	6"			A1701.7/16
1.1/2	38.10	1.5000	3"	6"			A1701.1/2

A160



- 普通长度钻头
- Broca Série Curta
- Broca , serie corta
- Jobber Drill

A160

A160	▪	3.1	3.2	3.3	3.4																
	•	1.1	1.2	1.3	1.4	1.5	1.6	2.1	2.2	2.3	4.1	4.2	4.3	5.1	5.2	5.3	6.1	6.2	6.3	6.4	7.1
		7.2	7.3	7.4	8.2	9.1															



d_1 \varnothing_{h_8} mm	d_1 decimal Inch	l_2 mm	l_1 mm	A160
4.00	0.1575	43	75	A1604.0
4.50	0.1772	47	80	A1604.5
5.00	0.1969	52	86	A1605.0
5.50	0.2165	57	93	A1605.5
6.00	0.2362	57	93	A1606.0
6.50	0.2559	63	101	A1606.5
6.80	0.2677	69	109	A1606.8
7.00	0.2756	69	109	A1607.0
7.50	0.2953	69	109	A1607.5
8.00	0.3150	75	117	A1608.0
8.50	0.3346	75	117	A1608.5
9.00	0.3543	81	125	A1609.0
9.50	0.3740	81	125	A1609.5
10.00	0.3937	87	133	A16010.0
10.20	0.4016	87	133	A16010.2
10.50	0.4134	87	133	A16010.5
11.00	0.4331	94	142	A16011.0
11.50	0.4528	94	142	A16011.5
12.00	0.4724	101	151	A16012.0
13.00	0.5118	101	151	A16013.0
14.00	0.5512	108	160	A16014.0
15.00	0.5906	114	169	A16015.0
16.00	0.6299	120	178	A16016.0

A510

HSS

DIN
338

4XD



- ADX 普通长度钻头
- Broca ADX Série Normal
- Broca ADX , serie corta
- ADX Jobber Drill

A510

A510	▪	1.1	1.2	1.3	1.4	1.5	2.1	2.2	3.1	3.2	3.3	3.4	6.2	6.3	7.2	7.3	7.4	8.1	8.2	8.3				
	•	1.6	2.3	4.1	4.2	4.3	5.1	5.2	5.3	6.1	6.4	7.1												

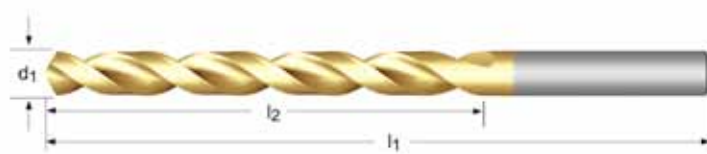

d_1 $\varnothing h_8$ Inch	d_1 $\varnothing h_8$ mm	d_1 decimal Inch	l_2 mm	l_1 mm	A510
	3.00	0.1181	33	61	A5103.0
	3.10	0.1220	36	65	A5103.1
1/8	3.18	0.1252	36	65	A5101/8
	3.20	0.1260	36	65	A5103.2
	3.30	0.1299	36	65	A5103.3
	3.40	0.1339	39	70	A5103.4
	3.50	0.1378	39	70	A5103.5
9/64	3.57	0.1406	39	70	A5109/64
	3.60	0.1417	39	70	A5103.6
	3.70	0.1457	39	70	A5103.7
	3.80	0.1496	43	75	A5103.8
	3.90	0.1535	43	75	A5103.9
5/32	3.97	0.1563	43	75	A5105/32
	4.00	0.1575	43	75	A5104.0
	4.10	0.1614	43	75	A5104.1
	4.20	0.1654	43	75	A5104.2
	4.30	0.1693	47	80	A5104.3
11/64	4.37	0.1720	47	80	A51011/64
	4.40	0.1732	47	80	A5104.4
	4.50	0.1772	47	80	A5104.5
	4.60	0.1811	47	80	A5104.6
	4.70	0.1850	47	80	A5104.7
3/16	4.76	0.1874	52	86	A5103/16
	4.80	0.1890	52	86	A5104.8
	4.90	0.1929	52	86	A5104.9
	5.00	0.1969	52	86	A5105.0
	5.10	0.2008	52	86	A5105.1
13/64	5.16	0.2031	52	86	A51013/64
	5.20	0.2047	52	86	A5105.2
	5.30	0.2087	52	86	A5105.3
	5.40	0.2126	57	93	A5105.4
	5.50	0.2165	57	93	A5105.5
7/32	5.56	0.2189	57	93	A5107/32
	5.60	0.2205	57	93	A5105.6
	5.70	0.2244	57	93	A5105.7
	5.80	0.2283	57	93	A5105.8

d_1 Øh ₈ Inch	d_1 Øh ₈ mm	d_1 decimal Inch	l_2 mm	l_1 mm	A510
15/64	5.90	0.2323	57	93	A5105.9
	5.95	0.2343	57	93	A51015/64
	6.00	0.2362	57	93	A5106.0
	6.10	0.2402	63	101	A5106.1
	6.20	0.2441	63	101	A5106.2
1/4	6.30	0.2480	63	101	A5106.3
	6.35	0.2500	63	101	A5101/4
	6.40	0.2520	63	101	A5106.4
	6.50	0.2559	63	101	A5106.5
	6.60	0.2598	63	101	A5106.6
17/64	6.70	0.2638	63	101	A5106.7
	6.75	0.2657	69	109	A51017/64
	6.80	0.2677	69	109	A5106.8
	6.90	0.2717	69	109	A5106.9
	7.00	0.2756	69	109	A5107.0
9/32	7.10	0.2795	69	109	A5107.1
	7.14	0.2811	69	109	A5109/32
	7.20	0.2835	69	109	A5107.2
	7.30	0.2874	69	109	A5107.3
	7.40	0.2913	69	109	A5107.4
19/64	7.50	0.2953	69	109	A5107.5
	7.54	0.2969	75	117	A51019/64
	7.60	0.2992	75	117	A5107.6
	7.70	0.3031	75	117	A5107.7
	7.80	0.3071	75	117	A5107.8
5/16	7.90	0.3110	75	117	A5107.9
	7.94	0.3126	75	117	A5105/16
	8.00	0.3150	75	117	A5108.0
	8.10	0.3189	75	117	A5108.1
	8.20	0.3228	75	117	A5108.2
21/64	8.30	0.3268	75	117	A5108.3
	8.33	0.3280	75	117	A51021/64
	8.40	0.3307	75	117	A5108.4
	8.50	0.3346	75	117	A5108.5
	8.60	0.3386	81	125	A5108.6
11/32	8.70	0.3425	81	125	A5108.7
	8.73	0.3437	81	125	A51011/32
	8.80	0.3465	81	125	A5108.8
	8.90	0.3504	81	125	A5108.9
	9.00	0.3543	81	125	A5109.0
23/64	9.10	0.3583	81	125	A5109.1
	9.13	0.3594	81	125	A51023/64
	9.20	0.3622	81	125	A5109.2
	9.30	0.3661	81	125	A5109.3
	9.40	0.3701	81	125	A5109.4
3/8	9.50	0.3740	81	125	A5109.5
	9.52	0.3748	87	133	A5103/8
	9.60	0.3780	87	133	A5109.6
	9.70	0.3819	87	133	A5109.7
	9.80	0.3858	87	133	A5109.8
25/64	9.90	0.3898	87	133	A5109.9
	9.92	0.3906	87	133	A51025/64
	10.00	0.3937	87	133	A51010.0
	10.10	0.3976	87	133	A51010.1
	10.20	0.4016	87	133	A51010.2
13/32	10.30	0.4055	87	133	A51010.3
	10.32	0.4063	87	133	A51013/32
	10.40	0.4094	87	133	A51010.4
	10.50	0.4134	87	133	A51010.5
	10.60	0.4173	87	133	A51010.6
27/64	10.70	0.4213	94	142	A51010.7
	10.72	0.4220	94	142	A51027/64
	10.80	0.4252	94	142	A51010.8
	10.90	0.4291	94	142	A51010.9
	11.00	0.4331	94	142	A51011.0
7/16	11.10	0.4370	94	142	A51011.1
	11.11	0.4374	94	142	A5107/16
	11.20	0.4409	94	142	A51011.2
	11.30	0.4449	94	142	A51011.3
	11.40	0.4488	94	142	A51011.4

d_1 $\varnothing h_8$ Inch	d_1 $\varnothing h_8$ mm	d_1 decimal Inch	l_2 mm	l_1 mm	A510
	11.50	0.4528	94	142	A51011.5
29/64	11.51	0.4531	94	142	A51029/64
	11.60	0.4567	94	142	A51011.6
	11.70	0.4606	94	142	A51011.7
	11.80	0.4646	94	142	A51011.8
	11.90	0.4685	101	151	A51011.9
15/32	11.91	0.4689	101	151	A51015/32
	12.00	0.4724	101	151	A51012.0
	12.10	0.4764	101	151	A51012.1
	12.20	0.4803	101	151	A51012.2
	12.30	0.4843	101	151	A51012.3
31/64	12.30	0.4843	101	151	A51031/64
	12.40	0.4882	101	151	A51012.4
	12.50	0.4921	101	151	A51012.5
	12.60	0.4961	101	151	A51012.6
	12.70	0.5000	101	151	A51012.7
1/2	12.70	0.5000	101	151	A5101/2
	12.80	0.5039	101	151	A51012.8
	12.90	0.5079	101	151	A51012.9
	13.00	0.5118	101	151	A51013.0
	14.00	0.5512	108	160	A51014.0



- A553**
- ADX 钻头 内冷
 - Broca ADX com refrigeração interna
- A554**
- Broca ADX - refrigeración interna
 - ADX Drill Oil Feed

A553; A554	1.1	1.2	1.3	1.4	1.5	1.6	2.1	2.2	3.1	3.2	3.3	3.4	4.1	6.2	6.3	7.2	7.3	7.4	8.1
	2.3	4.2	4.3	5.1	5.2	5.3	6.1	6.4	7.1										

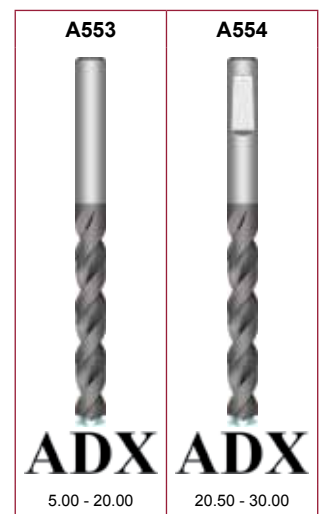

d_1 $\varnothing h_8$ mm	d_1 decimal Inch	l_2 mm	l_1 mm	l_3 mm	d_2 $\varnothing h_6$ mm	A553	A554
5.00	0.1969	36	79	36	6	A5535.0	
5.20	0.2047	38	79	36	6	A5535.2	
5.50	0.2165	40	79	36	6	A5535.5	
6.00	0.2362	43	79	36	6	A5536.0	
6.30	0.2480	46	87	36	8	A5536.3	
6.50	0.2559	47	87	36	8	A5536.5	
6.80	0.2677	48	87	36	8	A5536.8	
6.90	0.2717	48	87	36	8	A5536.9	
7.00	0.2756	48	87	36	8	A5537.0	
7.40	0.2913	54	94	36	8	A5537.4	
7.50	0.2953	54	94	36	8	A5537.5	
8.00	0.3150	58	94	36	8	A5538.0	
8.50	0.3346	75	130	40	10	A5538.5	
8.70	0.3425	75	130	40	10	A5538.7	
9.00	0.3543	75	130	40	10	A5539.0	
9.50	0.3740	75	130	40	10	A5539.5	
10.00	0.3937	75	130	40	10	A55310.0	
10.20	0.4016	87	150	45	12	A55310.2	
10.30	0.4055	87	150	45	12	A55310.3	
10.50	0.4134	87	150	45	12	A55310.5	
11.00	0.4330	94	150	45	12	A55311.0	
11.30	0.4449	94	150	45	12	A55311.3	
11.50	0.4528	94	150	45	12	A55311.5	
12.00	0.4724	94	150	45	12	A55312.0	
12.50	0.4921	101	160	45	14	A55312.5	
13.00	0.5118	101	160	45	14	A55313.0	
13.50	0.5315	101	160	45	14	A55313.5	
14.00	0.5512	101	160	45	14	A55314.0	
14.25	0.5610	108	170	48	16	A55314.25	
14.50	0.5709	108	170	48	16	A55314.5	

d_1 $\varnothing h_8$ mm	d_1 decimal Inch	l_2 mm	l_1 mm	l_3 mm	d_2 $\varnothing h_6$ mm	A553	A554
15.00	0.5906	108	170	48	16	A55315.0	
15.25	0.6004	108	170	48	16	A55315.25	
15.50	0.6102	108	170	48	16	A55315.5	
16.00	0.6299	108	170	48	16	A55316.0	
16.50	0.6496	125	190	48	18	A55316.5	
17.00	0.6693	125	190	48	18	A55317.0	
17.50	0.6890	130	190	48	18	A55317.5	
17.75	0.6988	130	190	48	18	A55317.75	
18.00	0.7087	130	190	48	18	A55318.0	
19.00	0.7480	135	200	50	20	A55319.0	
19.25	0.7579	140	200	50	20	A55319.25	
20.00	0.7874	140	200	50	20	A55320.0	
20.50	0.8071	141	219	56	25		A55420.5
21.00	0.8268	141	219	56	25		A55421.0
21.50	0.8465	148	226	56	25		A55421.5
22.00	0.8661	148	226	56	25		A55422.0
22.50	0.8858	155	233	56	25		A55422.5
23.00	0.9055	155	233	56	25		A55423.0
24.00	0.9449	162	240	56	25		A55424.0
24.50	0.9646	168	240	56	25		A55424.5
25.00	0.9843	168	246	56	25		A55425.0
26.00	1.0236	175	257	60	32		A55426.0
26.50	1.0433	182	264	60	32		A55426.5
27.00	1.0630	182	264	60	32		A55427.0
28.00	1.1024	189	271	60	32		A55428.0
29.00	1.1417	195	277	60	32		A55429.0
29.50	1.1614	202	284	60	32		A55429.5
30.00	1.1811	202	284	60	32		A55430.0



- A900**
- PFX 普通长度钻头
 - Broca PFX Série Normal
- A901**
- Broca PFX Serie Corta
 - PFX Jobber Drill

A900	▪	1.1	1.2	1.3	1.4	1.5	1.6	2.1	2.2	2.3	4.1	4.2	4.3	5.1	5.2	5.3	7.2
	•	3.1	3.2	3.3	3.4	6.1	6.2	6.3	6.4	7.1	7.3	7.4	8.1	8.2			
A901	▪	1.1	1.2	1.3	1.4	1.5	1.6	2.1	2.2	2.3	3.1	3.2	3.3	3.4	7.4		
	•	4.1	4.2	4.3	5.1	5.2	5.3	6.3	6.4								

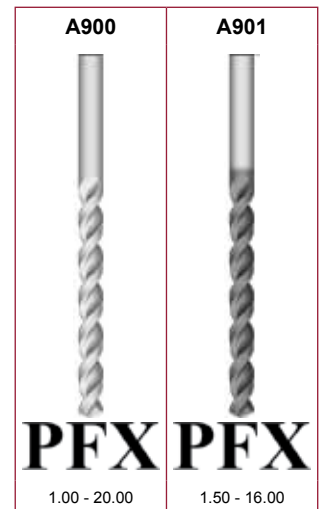
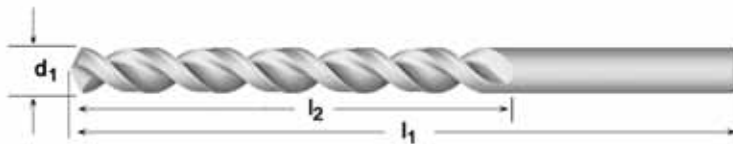

d_1 $\varnothing h_8$ Inch	d_1 $\varnothing h_8$ mm	d_1 decimal Inch	l_2 mm	l_1 mm	A900	A901
	1.00	0.0394	12	34	A9001.0	
	1.10	0.0433	14	36	A9001.1	
3/64	1.19	0.0469	19	44	A9003/64	
	1.20	0.0472	16	38	A9001.2	
	1.25	0.0492	16	36	A9001.25	
	1.30	0.0512	16	38	A9001.3	
	1.35	0.0531	18	40	A9001.35	
	1.40	0.0551	18	40	A9001.4	
	1.45	0.0571	18	40	A9001.45	
	1.50	0.0591	18	40	A9001.5	A9011.5
	1.55	0.0610	20	43	A9001.55	A9011.55
1/16	1.59	0.0626	22	48	A9001/16	A9011/16
	1.60	0.0630	20	43	A9001.6	A9011.6
	1.70	0.0669	20	43	A9001.7	
	1.75	0.0689	22	46	A9001.75	A9011.75
	1.80	0.0709	22	46	A9001.8	A9011.8
	1.90	0.0748	22	46	A9001.9	A9011.9
5/64	1.98	0.0780	25	51	A9005/64	A9015/64
	2.00	0.0787	24	49	A9002.0	A9012.0
	2.10	0.0827	24	49	A9002.1	A9012.1
	2.15	0.0846	27	53	A9002.15	A9012.15
	2.20	0.0866	27	53	A9002.2	
	2.30	0.0906	27	53	A9002.3	
	2.35	0.0925	27	53	A9002.35	A9012.35
3/32	2.38	0.0937	32	57	A9003/32	A9013/32
	2.40	0.0945	30	57	A9002.4	A9012.4
	2.50	0.0984	30	57	A9002.5	A9012.5
	2.60	0.1024	30	57	A9002.6	A9012.6

d_1 \varnothing_{h_8} Inch	d_1 \varnothing_{h_8} mm	d_1 decimal Inch	l_2 mm	l_1 mm	A900	A901
7/64	2.70	0.1063	33	61	A9002.7	A9012.7
	2.78	0.1094	38	67	A9007/64	A9017/64
	2.80	0.1102	33	61	A9002.8	
	2.90	0.1142	33	61	A9002.9	A9012.9
	3.00	0.1181	33	61	A9003.0	A9013.0
1/8	3.10	0.1220	36	65	A9003.1	A9013.1
	3.18	0.1252	41	70	A9001/8	A9011/8
	3.20	0.1260	36	65	A9003.2	A9013.2
	3.30	0.1299	36	65	A9003.3	A9013.3
	3.40	0.1339	39	70	A9003.4	A9013.4
9/64	3.50	0.1378	39	70	A9003.5	A9013.5
	3.57	0.1406	44	73	A9009/64	A9019/64
	3.60	0.1417	39	70	A9003.6	A9013.6
	3.70	0.1457	39	70	A9003.7	A9013.7
	3.80	0.1496	43	75	A9003.8	A9013.8
5/32	3.90	0.1535	43	75	A9003.9	A9013.9
	3.97	0.1563	51	79	A9005/32	A9015/32
	4.00	0.1575	43	75	A9004.0	A9014.0
	4.10	0.1614	43	75	A9004.1	A9014.1
	4.20	0.1654	43	75	A9004.2	A9014.2
11/64	4.30	0.1693	47	80	A9004.3	A9014.3
	4.37	0.1720	54	83	A9011/64	A9011/64
	4.40	0.1732	47	80	A9004.4	A9014.4
	4.50	0.1772	47	80	A9004.5	A9014.5
	4.60	0.1811	47	80	A9004.6	A9014.6
3/16	4.70	0.1850	47	80	A9004.7	A9014.7
	4.76	0.1874	59	89	A9003/16	A9013/16
	4.80	0.1890	52	86	A9004.8	A9014.8
	4.90	0.1929	52	86	A9004.9	A9014.9
	5.00	0.1969	52	86	A9005.0	A9015.0
13/64	5.10	0.2008	52	86	A9005.1	A9015.1
	5.16	0.2031	62	92	A90013/64	A90113/64
	5.20	0.2047	52	86	A9005.2	A9015.2
	5.30	0.2087	52	86	A9005.3	A9015.3
	5.40	0.2126	57	93	A9005.4	A9015.4
7/32	5.50	0.2165	57	93	A9005.5	A9015.5
	5.56	0.2189	64	95	A9007/32	A9017/32
	5.60	0.2205	57	93	A9005.6	A9015.6
	5.70	0.2244	57	93	A9005.7	A9015.7
	5.80	0.2283	57	93	A9005.8	A9015.8
15/64	5.90	0.2323	57	93	A9005.9	A9015.9
	5.95	0.2343	67	98	A90015/64	A90115/64
	6.00	0.2362	57	93	A9006.0	A9016.0
	6.10	0.2402	63	101	A9006.1	A9016.1
	6.20	0.2441	63	101	A9006.2	A9016.2
1/4	6.30	0.2480	63	101	A9006.3	A9016.3
	6.35	0.2500	70	102	A9001/4	A9011/4
	6.40	0.2520	63	101	A9006.4	A9016.4
	6.50	0.2559	63	101	A9006.5	A9016.5
	6.60	0.2598	63	101	A9006.6	A9016.6
17/64	6.70	0.2638	63	101	A9006.7	A9016.7
	6.75	0.2657	73	105	A90017/64	A90117/64
	6.80	0.2677	69	109	A9006.8	A9016.8
	6.90	0.2717	69	109	A9006.9	A9016.9
	7.00	0.2756	69	109	A9007.0	A9017.0
9/32	7.10	0.2795	69	109	A9007.1	A9017.1
	7.14	0.2811	75	108	A9009/32	A9019/32
	7.20	0.2835	69	109	A9007.2	A9017.2
	7.30	0.2874	69	109	A9007.3	A9017.3
	7.40	0.2913	69	109	A9007.4	A9017.4
19/64	7.50	0.2953	69	109	A9007.5	A9017.5
	7.54	0.2969	78	111	A90019/64	A90119/64
	7.60	0.2992	75	117	A9007.6	A9017.6
	7.70	0.3031	75	117	A9007.7	A9017.7
	7.80	0.3071	75	117	A9007.8	A9017.8
5/16	7.90	0.3110	75	117	A9007.9	A9017.9
	7.94	0.3126	81	114	A9005/16	A9015/16
	8.00	0.3150	75	117	A9008.0	A9018.0

d_1 $\varnothing h_8$ Inch	d_1 $\varnothing h_8$ mm	d_1 decimal Inch	l_2 mm	l_1 mm	A900	A901
	8.10	0.3189	75	117	A9008.1	A9018.1
	8.20	0.3228	75	117	A9008.2	A9018.2
	8.30	0.3268	75	117	A9008.3	A9018.3
21/64	8.33	0.3280	84	117	A90021/64	A90121/64
	8.40	0.3307	75	117	A9008.4	A9018.4
	8.50	0.3346	75	117	A9008.5	A9018.5
	8.60	0.3386	81	125	A9008.6	A9018.6
	8.70	0.3425	81	125	A9008.7	A9018.7
11/32	8.73	0.3437	87	121	A90011/32	A90111/32
	8.80	0.3465	81	125	A9008.8	A9018.8
	8.90	0.3504	81	125	A9008.9	A9018.9
	9.00	0.3543	81	125	A9009.0	A9019.0
	9.10	0.3583	81	125	A9009.1	A9019.1
23/64	9.13	0.3594	89	124	A90023/64	A90123/64
	9.20	0.3622	81	125	A9009.2	A9019.2
	9.30	0.3661	81	125	A9009.3	A9019.3
	9.40	0.3701	81	125	A9009.4	A9019.4
	9.50	0.3740	81	125	A9009.5	A9019.5
3/8	9.52	0.3748	92	127	A9003/8	A9013/8
	9.60	0.3780	87	133	A9009.6	A9019.6
	9.70	0.3819	87	133	A9009.7	A9019.7
	9.80	0.3858	87	133	A9009.8	A9019.8
	9.90	0.3898	87	133	A9009.9	A9019.9
25/64	9.92	0.3906	95	130	A90025/64	A90125/64
	10.00	0.3937	87	133	A90010.0	A90110.0
	10.20	0.4016	87	133	A90010.2	A90110.2
	10.30	0.4055	87	133	A90010.3	A90110.3
13/32	10.32	0.4063	98	133	A90013/32	A90113/32
	10.40	0.4094	87	133	A90010.4	A90110.4
	10.50	0.4134	87	133	A90010.5	A90110.5
27/64	10.72	0.4220	100	137	A90027/64	A90127/64
	10.75	0.4232	94	142	A90010.75	A90110.75
	10.80	0.4252	94	142	A90010.8	A90110.8
	11.00	0.4331	94	142	A90011.0	A90111.0
7/16	11.11	0.4374	103	140	A9007/16	A9017/16
	11.20	0.4409	94	142	A90011.2	A90111.2
	11.25	0.4429	94	142	A90011.25	A90111.25
	11.50	0.4528	94	142	A90011.5	A90111.5
29/64	11.51	0.4531	106	143	A90029/64	A90129/64
	11.80	0.4646	94	142	A90011.8	A90111.8
15/32	11.91	0.4689	110	146	A90015/32	A90115/32
	12.00	0.4724	101	151	A90012.0	A90112.0
	12.20	0.4803	101	151	A90012.2	A90112.2
31/64	12.30	0.4843	111	149	A90031/64	A90131/64
	12.50	0.4921	101	151	A90012.5	A90112.5
1/2	12.70	0.5000	101	151		A9011/2
1/2	12.70	0.5000	114	152	A9001/2	
	12.75	0.5020	101	151	A90012.75	A90112.75
	12.80	0.5039	101	151	A90012.8	A90112.8
	12.90	0.5079	101	151	A90012.9	
	13.00	0.5118	101	151	A90013.0	A90113.0
33/64	13.10	0.5157	122	168	A90033/64	A90133/64
	13.50	0.5315	108	160	A90013.5	A90113.5
35/64	13.89	0.5469	122	168	A90035/64	A90135/64
	14.00	0.5512	108	160	A90014.0	A90114.0
9/16	14.29	0.5626	122	168	A9009/16	A9019/16
	14.50	0.5709	114	169	A90014.5	A90114.5
37/64	14.68	0.5780	122	168	A90037/64	A90137/64
	14.75	0.5807	114	169	A90014.75	A90114.75
	15.00	0.5906	114	169	A90015.0	A90115.0
19/32	15.08	0.5937	132	181	A90019/32	A90119/32
39/64	15.48	0.6094	132	181	A90039/64	A90139/64
	15.50	0.6102	120	178	A90015.5	A90115.5
5/8	15.88	0.6252	132	181	A9005/8	A9015/8
	16.00	0.6299	120	178	A90016.0	A90116.0
41/64	16.27	0.6406	132	181	A90041/64	
	16.50	0.6496	125	184	A90016.5	
21/32	16.67	0.6563	132	181	A90021/32	

d_1 $\varnothing h_8$ Inch	d_1 $\varnothing h_8$ mm	d_1 decimal Inch	l_2 mm	l_1 mm	A900	A901
	16.75	0.6594	125	184	A90016.75	
	17.00	0.6693	125	184	A90017.0	
43/64	17.07	0.6720	143	194	A90043/64	
11/16	17.46	0.6874	143	194	A90011/16	
	17.50	0.6890	130	191	A90017.5	
45/64	17.86	0.7031	130	191	A90045/64	
	18.00	0.7087	130	191	A90018.0	
23/32	18.26	0.7189	130	191	A90023/32	
	18.50	0.7283	135	198	A90018.5	
47/64	18.65	0.7343	135	198	A90047/64	
	19.00	0.7480	135	198	A90019.0	
3/4	19.05	0.7500	135	198	A9003/4	
49/64	19.45	0.7657	135	198	A90049/64	
	19.50	0.7677	140	205	A90019.5	
25/32	19.84	0.7811	140	205	A90025/32	
	20.00	0.7874	140	205	A90020.0	



A243 • 航空用钻头 总长 150 mm
 • Broca Longa para Indústria Aeronáutica Comprimento total 150mm

A244 • Broca extralarga para la industria Aeronáutica Longitud Total 150 mm
 • Aircraft Extension Drill 6" Overall Length

A243; A244	▪	1.5	1.6	2.2	2.3	3.4	4.1	4.2	4.3	5.1	6.4	7.4
	•	1.3	1.4	2.1	3.1	3.2	3.3	5.2	5.3	6.3	9.1	



d_1 $\varnothing h_8$ Inch	d_1 decimal Inch	l_2 Inch	l_1 Inch	A243	A244
3/32	0.0938	1.1/4	6"	A2433/32X6	
40	0.0980	1.3/8	6"	A243N40X6	
1/8	0.1250	1.5/8	6"	A2431/8X6	A2441/8X6
30	0.1285	1.5/8	6"	A243N30X6	
5/32	0.1563	2"	6"	A2435/32X6	A2445/32X6
21	0.1590	2.1/8	6"	A243N21X6	
20	0.1610	2.1/8	6"	A243N20X6	
3/16	0.1875	2.5/16	6"	A2433/16X6	A2443/16X6
11	0.1910	2.5/16	6"	A243N11X6	
10	0.1935	2.7/16	6"	A243N10X6	
1/4	0.2500	2.3/4	6"	A2431/4X6	A2441/4X6

A110



A110

- 长系列钻头
- Broca Série Longa
- Broca, serie larga
- Long Series Drill

小于1.0 mm 和 1/16" 为光亮
 Brilhante abaixo de 1,0mm, 1/16"
 Brillante por debajo de 1,0mm, 1/16"
 Bright below 1.0mm, 1/16"

A110	1.1	1.2	1.3	1.4	1.5	1.6	2.1	2.2	2.3	3.1	3.2	3.3	3.4	4.1	4.2	4.3	5.1	5.2	5.3	6.1	
	6.2	6.3	6.4	7.1	7.2	7.3	7.4	8.1	8.2	8.3	9.1										



d_1 $\varnothing h_8$ Inch	d_1 $\varnothing h_8$ mm	d_1 decimal Inch	l_2 mm	l_1 mm	A110
	0.50	0.0197	12	32	A110.5
	0.60	0.0236	15	35	A110.6
	0.70	0.0276	21	42	A110.7
1/32	0.79	0.0311	25	46	A1101/32
	0.80	0.0315	25	46	A110.8
	0.90	0.0354	29	51	A110.9
	1.00	0.0394	33	56	A1101.0
	1.10	0.0433	37	60	A1101.1
	1.20	0.0472	41	65	A1101.2
	1.30	0.0512	41	65	A1101.3
	1.40	0.0551	45	70	A1101.4
	1.50	0.0591	45	70	A1101.5
1/16	1.59	0.0626	50	76	A1101/16
	1.60	0.0630	50	76	A1101.6
	1.70	0.0669	50	76	A1101.7
	1.75	0.0689	53	80	A1101.75
	1.80	0.0709	53	80	A1101.8
	1.90	0.0748	53	80	A1101.9
5/64	1.98	0.0780	56	85	A1105/64
	2.00	0.0787	56	85	A1102.0
	2.05	0.0807	56	85	A1102.05
	2.10	0.0827	56	85	A1102.1
	2.20	0.0866	59	90	A1102.2
	2.25	0.0886	59	90	A1102.25
	2.30	0.0906	59	90	A1102.3
3/32	2.38	0.0937	62	95	A1103/32
	2.40	0.0945	62	95	A1102.4
	2.50	0.0984	62	95	A1102.5
	2.60	0.1024	62	95	A1102.6
	2.70	0.1063	66	100	A1102.7
7/64	2.78	0.1094	66	100	A1107/64
	2.80	0.1102	66	100	A1102.8
	2.90	0.1142	66	100	A1102.9
	3.00	0.1181	66	100	A1103.0
	3.10	0.1220	69	106	A1103.1
1/8	3.18	0.1252	69	106	A1101/8

d_1 $\varnothing h_8$ Inch	d_1 $\varnothing h_8$ mm	d_1 decimal Inch	l_2 mm	l_1 mm	A110
	3.20	0.1260	69	106	A1103.2
	3.25	0.1280	69	106	A1103.25
	3.30	0.1299	69	106	A1103.3
	3.40	0.1339	73	112	A1103.4
	3.50	0.1378	73	112	A1103.5
9/64	3.57	0.1406	73	112	A1109/64
	3.60	0.1417	73	112	A1103.6
	3.70	0.1457	73	112	A1103.7
	3.75	0.1476	73	112	A1103.75
	3.80	0.1496	78	119	A1103.8
	3.90	0.1535	78	119	A1103.9
5/32	3.97	0.1563	78	119	A1105/32
	4.00	0.1575	78	119	A1104.0
	4.10	0.1614	78	119	A1104.1
	4.20	0.1654	78	119	A1104.2
	4.25	0.1673	78	119	A1104.25
	4.30	0.1693	82	126	A1104.3
11/64	4.37	0.1720	82	126	A11011/64
	4.40	0.1732	82	126	A1104.4
	4.50	0.1772	82	126	A1104.5
	4.60	0.1811	82	126	A1104.6
	4.70	0.1850	82	126	A1104.7
	4.75	0.1870	82	126	A1104.75
3/16	4.76	0.1874	87	132	A1103/16
	4.80	0.1890	87	132	A1104.8
	4.90	0.1929	87	132	A1104.9
	5.00	0.1969	87	132	A1105.0
	5.10	0.2008	87	132	A1105.1
13/64	5.16	0.2031	87	132	A11013/64
	5.20	0.2047	87	132	A1105.2
	5.25	0.2067	87	132	A1105.25
	5.30	0.2087	87	132	A1105.3
	5.40	0.2126	91	139	A1105.4
	5.50	0.2165	91	139	A1105.5
7/32	5.56	0.2189	91	139	A1107/32
	5.60	0.2205	91	139	A1105.6
	5.70	0.2244	91	139	A1105.7
	5.75	0.2264	91	139	A1105.75
	5.80	0.2283	91	139	A1105.8
	5.90	0.2323	91	139	A1105.9
15/64	5.95	0.2343	91	139	A11015/64
	6.00	0.2362	91	139	A1106.0
	6.10	0.2402	97	148	A1106.1
	6.20	0.2441	97	148	A1106.2
	6.25	0.2461	97	148	A1106.25
	6.30	0.2480	97	148	A1106.3
1/4	6.35	0.2500	97	148	A1101/4
	6.40	0.2520	97	148	A1106.4
	6.50	0.2559	97	148	A1106.5
	6.60	0.2598	97	148	A1106.6
	6.70	0.2638	97	148	A1106.7
17/64	6.75	0.2657	102	156	A11017/64
	6.75	0.2657	102	156	A1106.75
	6.80	0.2677	102	156	A1106.8
	6.90	0.2717	102	156	A1106.9
	7.00	0.2756	102	156	A1107.0
	7.10	0.2795	102	156	A1107.1
9/32	7.14	0.2811	102	156	A1109/32
	7.20	0.2835	102	156	A1107.2
	7.25	0.2854	102	156	A1107.25
	7.30	0.2874	102	156	A1107.3
	7.40	0.2913	102	156	A1107.4
	7.50	0.2953	102	156	A1107.5
	7.60	0.2992	109	165	A1107.6
	7.70	0.3031	109	165	A1107.7
	7.75	0.3051	109	165	A1107.75
	7.80	0.3071	109	165	A1107.8
	7.90	0.3110	109	165	A1107.9
5/16	7.94	0.3126	109	165	A1105/16
	8.00	0.3150	109	165	A1108.0

d_1 $\varnothing h_8$ Inch	d_1 $\varnothing h_8$ mm	d_1 decimal Inch	l_2 mm	l_1 mm	A110
	8.10	0.3189	109	165	A1108.1
	8.20	0.3228	109	165	A1108.2
	8.25	0.3248	109	165	A1108.25
	8.30	0.3268	109	165	A1108.3
	8.40	0.3307	109	165	A1108.4
	8.50	0.3346	109	165	A1108.5
	8.60	0.3386	115	175	A1108.6
	8.70	0.3425	115	175	A1108.7
11/32	8.73	0.3437	115	175	A11011/32
	8.75	0.3445	115	175	A1108.75
	8.80	0.3465	115	175	A1108.8
	8.90	0.3504	115	175	A1108.9
	9.00	0.3543	115	175	A1109.0
	9.10	0.3583	115	175	A1109.1
	9.20	0.3622	115	175	A1109.2
	9.25	0.3642	115	175	A1109.25
	9.30	0.3661	115	175	A1109.3
	9.40	0.3701	115	175	A1109.4
	9.50	0.3740	115	175	A1109.5
3/8	9.52	0.3748	121	184	A1103/8
	9.60	0.3780	121	184	A1109.6
	9.70	0.3819	121	184	A1109.7
	9.75	0.3839	121	184	A1109.75
	9.80	0.3858	121	184	A1109.8
	9.90	0.3898	121	184	A1109.9
	10.00	0.3937	121	184	A11010.0
	10.10	0.3976	121	184	A11010.1
	10.20	0.4016	121	184	A11010.2
	10.25	0.4035	121	184	A11010.25
	10.30	0.4055	121	184	A11010.3
13/32	10.32	0.4063	121	184	A11013/32
	10.50	0.4134	121	184	A11010.5
	10.75	0.4232	128	195	A11010.75
	10.80	0.4252	128	195	A11010.8
	11.00	0.4331	128	195	A11011.0
7/16	11.11	0.4374	128	195	A1107/16
	11.25	0.4429	128	195	A11011.25
	11.40	0.4488	128	195	A11011.4
	11.50	0.4528	128	195	A11011.5
	11.75	0.4626	128	195	A11011.75
	12.00	0.4724	134	205	A11012.0
	12.10	0.4764	134	205	A11012.1
	12.25	0.4823	134	205	A11012.25
	12.50	0.4921	134	205	A11012.5
1/2	12.70	0.5000	134	205	A1101/2
	13.00	0.5118	134	205	A11013.0
17/32	13.49	0.5311	140	214	A11017/32
	13.50	0.5315	140	214	A11013.5
	14.00	0.5512	140	214	A11014.0
9/16	14.29	0.5626	144	220	A1109/16
	14.50	0.5709	144	220	A11014.5
	15.00	0.5906	144	220	A11015.0
	15.50	0.6102	149	227	A11015.5
5/8	15.88	0.6252	149	227	A1105/8
	16.00	0.6299	149	227	A11016.0
	16.50	0.6496	154	235	A11016.5
	17.00	0.6693	154	235	A11017.0
11/16	17.46	0.6874	158	241	A11011/16
	17.50	0.6890	158	241	A11017.5
	18.00	0.7087	158	241	A11018.0
	18.50	0.7283	162	247	A11018.5
	19.00	0.7480	162	247	A11019.0
3/4	19.05	0.7500	166	254	A1103/4
	19.50	0.7677	166	254	A11019.5
	20.00	0.7874	166	254	A11020.0
	21.00	0.8268	171	261	A11021.0
	22.00	0.8661	176	268	A11022.0
7/8	22.22	0.8748	176	268	A1107/8
15/16	23.81	0.9374	185	282	A11015/16
1	25.40	1.0000	190	290	A1101



- A940**
- PFX 长系列钻头
 - Broca PFX Série Longa
- A941**
- Broca PFX, serie larga
 - PFX Long Series Drill

A940	▪	1.1	1.2	1.3	1.4	1.5	1.6	2.1	2.2	2.3	4.1	4.2	4.3	7.2	
	•	3.2	3.3	3.4	6.1	6.2	6.3	6.4	7.1	7.3	7.4	8.1	8.2		
A941	▪	1.1	1.2	1.3	1.4	1.5	1.6	2.1	2.2	2.3	3.1	3.2	3.3	3.4	7.4
	•	4.1	4.2	4.3	6.3	6.4									

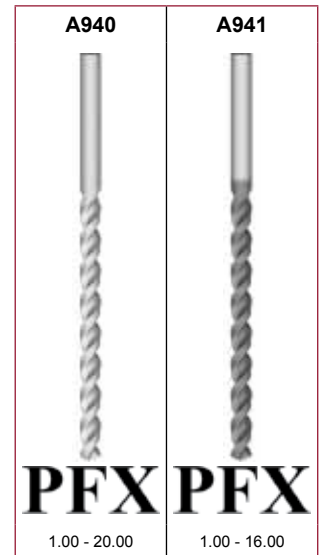

d_1 $\varnothing h_8$ Inch	d_1 $\varnothing h_8$ mm	d_1 decimal Inch	l_2 mm	l_1 mm	A940	A941
	1.00	0.0394	33	56	A9401.0	A9411.0
	1.10	0.0433	37	60	A9401.1	
3/64	1.19	0.0469	29	57	A9403/64	A9413/64
	1.20	0.0472	41	65	A9401.2	
	1.30	0.0512	41	65	A9401.3	
	1.40	0.0551	45	70	A9401.4	
	1.50	0.0591	45	70	A9401.5	A9411.5
1/16	1.59	0.0626	44	76	A9401/16	A9411/16
	1.60	0.0630	50	76	A9401.6	
	1.70	0.0669	50	76	A9401.7	
	1.80	0.0709	53	80	A9401.8	
	1.90	0.0748	53	80	A9401.9	
5/64	1.98	0.0780	51	95	A9405/64	A9415/64
	2.00	0.0787	56	85	A9402.0	A9412.0
	2.10	0.0827	56	85	A9402.1	
	2.20	0.0866	59	90	A9402.2	
	2.30	0.0906	59	90	A9402.3	
3/32	2.38	0.0937	57	108	A9403/32	A9413/32
	2.40	0.0945	62	95	A9402.4	
	2.50	0.0984	62	95	A9402.5	A9412.5
	2.60	0.1024	62	95	A9402.6	
	2.70	0.1063	66	100	A9402.7	
7/64	2.78	0.1094	64	117	A9407/64	A9417/64
	2.80	0.1102	66	100	A9402.8	
	2.90	0.1142	66	100	A9402.9	
	3.00	0.1181	66	100	A9403.0	A9413.0

d_1 $\varnothing h_8$ Inch	d_1 $\varnothing h_8$ mm	d_1 decimal Inch	l_2 mm	l_1 mm	A940	A941
1/8	3.10	0.1220	69	106	A9403.1	A9413.1
	3.18	0.1252	70	130	A9401/8	A9411/8
	3.20	0.1260	69	106	A9403.2	A9413.2
	3.30	0.1299	69	106	A9403.3	A9413.3
9/64	3.40	0.1339	73	112	A9403.4	A9413.4
	3.50	0.1378	73	112	A9403.5	A9413.5
	3.57	0.1406	76	137	A9409/64	A9419/64
	3.60	0.1417	73	112	A9403.6	A9413.6
	3.70	0.1457	73	112	A9403.7	A9413.7
	3.80	0.1496	78	119	A9403.8	A9413.8
5/32	3.90	0.1535	78	119	A9403.9	A9413.9
	3.97	0.1563	76	137	A9405/32	A9415/32
	4.00	0.1575	78	119	A9404.0	A9414.0
	4.10	0.1614	78	119	A9404.1	A9414.1
	4.20	0.1654	78	119	A9404.2	A9414.2
11/64	4.30	0.1693	82	126	A9404.3	A9414.3
	4.37	0.1720	86	146	A94011/64	A94111/64
	4.40	0.1732	82	126	A9404.4	A9414.4
	4.50	0.1772	82	126	A9404.5	A9414.5
	4.60	0.1811	82	126	A9404.6	A9414.6
	4.70	0.1850	82	126	A9404.7	A9414.7
3/16	4.76	0.1874	86	146	A9403/16	A9413/16
	4.80	0.1890	87	132	A9404.8	A9414.8
	4.90	0.1929	87	132	A9404.9	A9414.9
	5.00	0.1969	87	132	A9405.0	A9415.0
13/64	5.10	0.2008	87	132	A9405.1	A9415.1
	5.16	0.2031	92	152	A94013/64	A94113/64
	5.20	0.2047	87	132	A9405.2	A9415.2
	5.30	0.2087	87	132	A9405.3	A9415.3
	5.40	0.2126	91	139	A9405.4	A9415.4
7/32	5.50	0.2165	91	139	A9405.5	A9415.5
	5.56	0.2189	92	152	A9407/32	A9417/32
	5.60	0.2205	91	139	A9405.6	A9415.6
	5.70	0.2244	91	139	A9405.7	A9415.7
	5.80	0.2283	91	139	A9405.8	A9415.8
15/64	5.90	0.2323	91	139	A9405.9	A9415.9
	5.95	0.2343	95	156	A94015/64	A94115/64
	6.00	0.2362	91	139	A9406.0	A9416.0
	6.10	0.2402	97	148	A9406.1	A9416.1
1/4	6.20	0.2441	97	148	A9406.2	A9416.2
	6.30	0.2480	97	148	A9406.3	A9416.3
	6.35	0.2500	95	156	A9401/4	A9411/4
	6.40	0.2520	97	148	A9406.4	A9416.4
	6.50	0.2559	97	148	A9406.5	A9416.5
	6.60	0.2598	97	148	A9406.6	A9416.6
17/64	6.70	0.2638	97	148	A9406.7	A9416.7
	6.75	0.2657	98	159	A94017/64	A94117/64
	6.80	0.2677	102	156	A9406.8	A9416.8
	6.90	0.2717	102	156	A9406.9	A9416.9
	7.00	0.2756	102	156	A9407.0	A9417.0
9/32	7.10	0.2795	102	156	A9407.1	A9417.1
	7.14	0.2811	98	159	A9409/32	A9419/32
	7.20	0.2835	102	156	A9407.2	A9417.2
	7.30	0.2874	102	156	A9407.3	A9417.3
	7.40	0.2913	102	156	A9407.4	A9417.4
19/64	7.50	0.2953	102	156	A9407.5	A9417.5
	7.54	0.2969	102	162	A94019/64	A94119/64
	7.60	0.2992	109	165	A9407.6	A9417.6
	7.70	0.3031	109	165	A9407.7	A9417.7
	7.80	0.3071	109	165	A9407.8	A9417.8
	7.90	0.3110	109	165	A9407.9	A9417.9
5/16	7.94	0.3126	102	162	A9405/16	A9415/16
	8.00	0.3150	109	165	A9408.0	A9418.0
	8.10	0.3189	109	165	A9408.1	A9418.1
	8.20	0.3228	109	165	A9408.2	A9418.2
21/64	8.30	0.3268	109	165	A9408.3	A9418.3
	8.33	0.3280	105	165	A94021/64	A94121/64
	8.40	0.3307	109	165	A9408.4	A9418.4
	8.50	0.3346	109	165	A9408.5	A9418.5
	8.60	0.3386	115	175	A9408.6	A9418.6

d_1 $\varnothing h_8$ Inch	d_1 $\varnothing h_8$ mm	d_1 decimal Inch	l_2 mm	l_1 mm	A940	A941
	8.70	0.3425	115	175	A9408.7	A9418.7
11/32	8.73	0.3437	105	165	A94011/32	A94111/32
	8.80	0.3465	115	175	A9408.8	A9418.8
	8.90	0.3504	115	175	A9408.9	A9418.9
	9.00	0.3543	115	175	A9409.0	A9419.0
	9.10	0.3583	115	175	A9409.1	A9419.1
23/64	9.13	0.3594	108	171	A94023/64	A94123/64
	9.20	0.3622	115	175	A9409.2	A9419.2
	9.30	0.3661	115	175	A9409.3	A9419.3
	9.40	0.3701	115	175	A9409.4	A9419.4
	9.50	0.3740	115	175	A9409.5	A9419.5
3/8	9.52	0.3748	108	171	A9403/8	A9413/8
	9.60	0.3780	121	184	A9409.6	¹⁾ A9419.6
	9.70	0.3819	121	184	A9409.7	¹⁾ A9419.7
	9.80	0.3858	121	184	A9409.8	¹⁾ A9419.8
	9.90	0.3898	121	184	A9409.9	¹⁾ A9419.9
25/64	9.92	0.3906	111	178	A94025/64	¹⁾ A94125/64
	10.00	0.3937	121	184	A94010.0	¹⁾ A94110.0
	10.20	0.4016	121	184	A94010.2	¹⁾ A94110.2
	10.30	0.4055	121	184	A94010.3	¹⁾ A94110.3
13/32	10.32	0.4063	111	178	A94013/32	¹⁾ A94113/32
	10.40	0.4094	121	184	A94010.4	¹⁾ A94110.4
	10.50	0.4134	121	184	A94010.5	¹⁾ A94110.5
27/64	10.72	0.4220	117	184	A94027/64	¹⁾ A94127/64
	10.80	0.4252	128	195	A94010.8	¹⁾ A94110.8
	11.00	0.4331	128	195	A94011.0	¹⁾ A94111.0
7/16	11.11	0.4374	117	184	A9407/16	¹⁾ A9417/16
	11.20	0.4409	128	195	A94011.2	¹⁾ A94111.2
	11.50	0.4528	128	195	A94011.5	¹⁾ A94111.5
29/64	11.51	0.4531	121	190	A94029/64	¹⁾ A94129/64
	11.80	0.4646	128	195	A94011.8	¹⁾ A94111.8
15/32	11.91	0.4689	121	190	A94015/32	¹⁾ A94115/32
	12.00	0.4724	134	205	A94012.0	¹⁾ A94112.0
	12.20	0.4803	134	205	A94012.2	¹⁾ A94112.2
31/64	12.30	0.4843	121	197	A94031/64	¹⁾ A94131/64
	12.50	0.4921	134	205	A94012.5	¹⁾ A94112.5
1/2	12.70	0.5000	121	197	A9401/2	¹⁾ A9411/2
	12.80	0.5039	134	205	A94012.8	¹⁾ A94112.8
	13.00	0.5118	134	205	A94013.0	¹⁾ A94113.0
33/64	13.10	0.5157	121	203	A94033/64	¹⁾ A94133/64
17/32	13.49	0.5311	121	203	A94017/32	¹⁾
	13.50	0.5315	140	214	A94013.5	¹⁾ A94113.5
35/64	13.89	0.5469	124	210	A94035/64	¹⁾ A94135/64
	14.00	0.5512	140	214	A94014.0	¹⁾ A94114.0
9/16	14.29	0.5626	124	210	A9409/16	¹⁾ A9419/16
	14.50	0.5709	144	220	A94014.5	¹⁾ A94114.5
37/64	14.68	0.5780	124	222	A94037/64	¹⁾ A94137/64
	15.00	0.5906	144	220	A94015.0	¹⁾ A94115.0
19/32	15.08	0.5937	124	222	A94019/32	¹⁾ A94119/32
39/64	15.48	0.6094	124	222	A94039/64	¹⁾ A94139/64
	15.50	0.6102	149	227	A94015.5	¹⁾ A94115.5
5/8	15.88	0.6252	124	222	A9405/8	¹⁾ A9415/8
	16.00	0.6299	149	227	A94016.0	¹⁾ A94116.0
41/64	16.27	0.6406	130	229	A94041/64	¹⁾
	16.50	0.6496	154	235	A94016.5	¹⁾
21/32	16.67	0.6563	130	229	A94021/32	¹⁾
	17.00	0.6693	154	235	A94017.0	¹⁾
43/64	17.07	0.6720	137	235	A94043/64	¹⁾
11/16	17.46	0.6874	137	235	A94011/16	¹⁾
	17.50	0.6890	158	241	A94017.5	¹⁾
45/64	17.86	0.7031	143	241	A94045/64	¹⁾
	18.00	0.7087	158	241	A94018.0	¹⁾
23/32	18.26	0.7189	143	241	A94023/32	¹⁾
47/64	18.65	0.7343	149	248	A94047/64	¹⁾
	19.00	0.7480	162	247	A94019.0	¹⁾
3/4	19.05	0.7500	149	248	A9403/4	¹⁾
49/64	19.45	0.7657	152	251	A94049/64	¹⁾
25/32	19.84	0.7811	152	251	A94025/32	¹⁾
	20.00	0.7874	166	254	A94020.0	¹⁾

¹⁾ < 10xD

A125

HSS

BS
328

10XD



A125

- 超长钻头 小于2.2 mm 和 5/64" 为光亮
- Broca Série Extra Longa Brilhante abaixo de 2.2mm, 5/64
- Broca serie extra larga Brillante por debajo de 2,2 mm, 5/64"
- Extra Length Drill Bright below 2.2mm, 5/64"

A125	1.1	1.2																		
	1.3	1.4	1.5	1.6	2.1	2.2	2.3	3.1	3.2	3.3	3.4	4.1	4.2	4.3	5.1	5.2	5.3	6.1	6.2	6.3
	6.4	7.1	7.2	7.3	7.4	8.1	8.2	8.3	9.1											

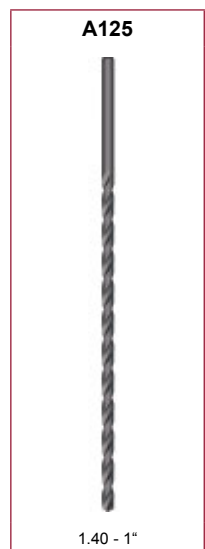

d_1 $\varnothing h_8$ Inch	d_1 $\varnothing h_8$ mm	d_1 decimal Inch	l_2 mm	l_1 mm	A125
	1.40	0.0551	100	160	A1251.4X160
	1.50	0.0591	80	125	A1251.5X125
	1.50	0.0591	100	160	A1251.5X160
1/16	1.59	0.0626	80	125	A1251/16X125
1/16	1.59	0.0626	100	160	A1251/16X160
	1.80	0.0709	100	160	A1251.8X160
5/64	1.98	0.0780	80	125	A1255/64X125
5/64	1.98	0.0780	100	160	A1255/64X160
	2.00	0.0787	80	125	A1252.0X125
	2.00	0.0787	100	160	A1252.0X160
	2.20	0.0866	100	160	A1252.2X160
3/32	2.38	0.0937	80	125	A1253/32X125
3/32	2.38	0.0937	100	160	A1253/32X160
	2.50	0.0984	80	125	A1252.5X125
	2.50	0.0984	100	160	A1252.5X160
7/64	2.78	0.1094	80	125	A1257/64X125
7/64	2.78	0.1094	100	160	A1257/64X160
	3.00	0.1181	100	160	A1253.0X160
	3.00	0.1181	150	200	A1253.0X200
	3.00	0.1181	200	250	A1253.0X250
1/8	3.18	0.1252	100	160	A1251/8X160
1/8	3.18	0.1252	150	200	A1251/8X200
1/8	3.18	0.1252	200	250	A1251/8X250
1/8	3.18	0.1252	250	310	A1251/8X315
	3.30	0.1299	100	160	A1253.3X160
	3.50	0.1378	100	160	A1253.5X160
	3.50	0.1378	150	200	A1253.5X200
	3.50	0.1378	200	250	A1253.5X250
9/64	3.57	0.1406	100	160	A1259/64X160
9/64	3.57	0.1406	150	200	A1259/64X200
9/64	3.57	0.1406	250	310	A1259/64X315
5/32	3.97	0.1563	100	160	A1255/32X160

d_1 Øh ₈ Inch	d_1 Øh ₈ mm	d_1 decimal Inch	l_2 mm	l_1 mm	A125
5/32	3.97	0.1563	150	200	A1255/32X200
5/32	3.97	0.1563	200	250	A1255/32X250
5/32	3.97	0.1563	250	310	A1255/32X315
	4.00	0.1575	100	160	A1254.0X160
	4.00	0.1575	150	200	A1254.0X200
	4.00	0.1575	200	250	A1254.0X250
	4.00	0.1575	250	310	A1254.0X315
11/64	4.37	0.1720	100	160	A12511/64X160
11/64	4.37	0.1720	150	200	A12511/64X200
11/64	4.37	0.1720	250	310	A12511/64X315
	4.50	0.1772	100	160	A1254.5X160
	4.50	0.1772	150	200	A1254.5X200
	4.50	0.1772	200	250	A1254.5X250
	4.50	0.1772	250	310	A1254.5X315
3/16	4.76	0.1874	100	160	A1253/16X160
3/16	4.76	0.1874	150	200	A1253/16X200
3/16	4.76	0.1874	200	250	A1253/16X250
3/16	4.76	0.1874	250	310	A1253/16X315
3/16	4.76	0.1874	300	400	A1253/16X400
	5.00	0.1969	100	160	A1255.0X160
	5.00	0.1969	150	200	A1255.0X200
	5.00	0.1969	200	250	A1255.0X250
	5.00	0.1969	250	310	A1255.0X315
	5.00	0.1969	300	400	A1255.0X400
13/64	5.16	0.2031	150	200	A12513/64X200
13/64	5.16	0.2031	200	250	A12513/64X250
13/64	5.16	0.2031	250	310	A12513/64X315
	5.50	0.2165	150	200	A1255.5X200
	5.50	0.2165	200	250	A1255.5X250
	5.50	0.2165	250	310	A1255.5X315
7/32	5.56	0.2189	150	200	A1257/32X200
7/32	5.56	0.2189	200	250	A1257/32X250
7/32	5.56	0.2189	250	310	A1257/32X315
15/64	5.95	0.2343	150	200	A12515/64X200
15/64	5.95	0.2343	200	250	A12515/64X250
15/64	5.95	0.2343	250	310	A12515/64X315
	6.00	0.2362	150	200	A1256.0X200
	6.00	0.2362	200	250	A1256.0X250
	6.00	0.2362	250	310	A1256.0X315
	6.00	0.2362	300	400	A1256.0X400
1/4	6.35	0.2500	150	200	A1251/4X200
1/4	6.35	0.2500	200	250	A1251/4X250
1/4	6.35	0.2500	250	310	A1251/4X315
1/4	6.35	0.2500	300	400	A1251/4X400
1/4	6.35	0.2500	400	460	A1251/4X500
	6.50	0.2559	150	200	A1256.5X200
	6.50	0.2559	200	250	A1256.5X250
	6.50	0.2559	250	310	A1256.5X315
17/64	6.75	0.2657	150	200	A12517/64X200
17/64	6.75	0.2657	200	250	A12517/64X250
17/64	6.75	0.2657	400	460	A12517/64X500
	7.00	0.2756	150	200	A1257.0X200
	7.00	0.2756	200	250	A1257.0X250
	7.00	0.2756	250	310	A1257.0X315
9/32	7.14	0.2811	150	200	A1259/32X200
9/32	7.14	0.2811	200	250	A1259/32X250
9/32	7.14	0.2811	250	310	A1259/32X315
9/32	7.14	0.2811	400	460	A1259/32X500
	7.50	0.2953	150	200	A1257.5X200
	7.50	0.2953	200	250	A1257.5X250
	7.50	0.2953	250	310	A1257.5X315
19/64	7.54	0.2969	250	310	A12519/64X315
19/64	7.54	0.2969	400	460	A12519/64X500
5/16	7.94	0.3126	150	200	A1255/16X200
5/16	7.94	0.3126	200	250	A1255/16X250
5/16	7.94	0.3126	250	310	A1255/16X315
5/16	7.94	0.3126	300	400	A1255/16X400
5/16	7.94	0.3126	400	460	A1255/16X500
	8.00	0.3150	200	250	A1258.0X250
	8.00	0.3150	250	310	A1258.0X315

d_1 \varnothing_{h_8} Inch	d_1 \varnothing_{h_8} mm	d_1 decimal Inch	l_2 mm	l_1 mm	A125
	8.00	0.3150	300	400	A1258.0X400
21/64	8.33	0.3280	250	310	A12521/64X315
21/64	8.33	0.3280	400	460	A12521/64X500
	8.50	0.3346	200	250	A1258.5X250
	8.50	0.3346	250	310	A1258.5X315
11/32	8.73	0.3437	200	250	A12511/32X250
11/32	8.73	0.3437	250	310	A12511/32X315
11/32	8.73	0.3437	300	400	A12511/32X400
11/32	8.73	0.3437	400	460	A12511/32X500
	9.00	0.3543	200	250	A1259.0X250
	9.00	0.3543	250	310	A1259.0X315
	9.00	0.3543	300	400	A1259.0X400
23/64	9.13	0.3594	250	310	A12523/64X315
23/64	9.13	0.3594	400	460	A12523/64X500
	9.50	0.3740	200	250	A1259.5X250
	9.50	0.3740	250	310	A1259.5X315
3/8	9.52	0.3748	200	250	A1253/8X250
3/8	9.52	0.3748	250	310	A1253/8X315
3/8	9.52	0.3748	300	400	A1253/8X400
3/8	9.52	0.3748	400	460	A1253/8X500
25/64	9.92	0.3906	250	310	A12525/64X315
25/64	9.92	0.3906	400	460	A12525/64X500
	10.00	0.3937	200	250	A12510.0X250
	10.00	0.3937	250	310	A12510.0X315
	10.00	0.3937	300	400	A12510.0X400
13/32	10.32	0.4063	200	250	A12513/32X250
13/32	10.32	0.4063	250	310	A12513/32X315
13/32	10.32	0.4063	400	460	A12513/32X500
	10.50	0.4134	200	250	A12510.5X250
	10.50	0.4134	250	310	A12510.5X315
	10.50	0.4134	300	400	A12510.5X400
27/64	10.72	0.4220	250	310	A12527/64X315
	11.00	0.4331	200	250	A12511.0X250
	11.00	0.4331	250	310	A12511.0X315
	11.00	0.4331	300	400	A12511.0X400
7/16	11.11	0.4374	200	250	A1257/16X250
7/16	11.11	0.4374	250	310	A1257/16X315
7/16	11.11	0.4374	300	400	A1257/16X400
7/16	11.11	0.4374	400	460	A1257/16X500
29/64	11.51	0.4531	250	310	A12529/64X315
29/64	11.51	0.4531	400	460	A12529/64X500
15/32	11.91	0.4689	200	250	A12515/32X250
15/32	11.91	0.4689	250	310	A12515/32X315
15/32	11.91	0.4689	400	460	A12515/32X500
	12.00	0.4724	200	250	A12512.0X250
	12.00	0.4724	250	310	A12512.0X315
	12.00	0.4724	300	400	A12512.0X400
31/64	12.30	0.4843	250	310	A12531/64X315
31/64	12.30	0.4843	400	460	A12531/64X500
1/2	12.70	0.5000	200	250	A1251/2X250
1/2	12.70	0.5000	250	310	A1251/2X315
1/2	12.70	0.5000	300	400	A1251/2X400
1/2	12.70	0.5000	400	460	A1251/2X500
	13.00	0.5118	250	310	A12513.0X315
	13.00	0.5118	300	400	A12513.0X400
33/64	13.10	0.5157	250	310	A12533/64X315
33/64	13.10	0.5157	400	460	A12533/64X500
17/32	13.49	0.5311	250	310	A12517/32X315
17/32	13.49	0.5311	400	460	A12517/32X500
35/64	13.89	0.5469	250	310	A12535/64X315
35/64	13.89	0.5469	400	460	A12535/64X500
	14.00	0.5512	250	310	A12514.0X315
	14.00	0.5512	300	400	A12514.0X400
9/16	14.29	0.5626	250	310	A1259/16X315
9/16	14.29	0.5626	400	460	A1259/16X500
37/64	14.68	0.5780	250	310	A12537/64X315
19/32	15.08	0.5937	250	310	A12519/32X315
19/32	15.08	0.5937	400	460	A12519/32X500

d_1 $\varnothing h_8$ Inch	d_1 $\varnothing h_8$ mm	d_1 decimal Inch	l_2 mm	l_1 mm	A125
39/64	15.48	0.6094	250	310	A12539/64X315
39/64	15.48	0.6094	400	460	A12539/64X500
5/8	15.88	0.6252	250	310	A1255/8X315
5/8	15.88	0.6252	400	460	A1255/8X500
21/32	16.67	0.6563	250	310	A12521/32X315
21/32	16.67	0.6563	400	460	A12521/32X500
11/16	17.46	0.6874	250	310	A12511/16X315
11/16	17.46	0.6874	400	460	A12511/16X500
23/32	18.26	0.7189	250	310	A12523/32X315
23/32	18.26	0.7189	400	460	A12523/32X500
3/4	19.05	0.7500	250	310	A1253/4X315
3/4	19.05	0.7500	400	460	A1253/4X500
25/32	19.84	0.7811	400	460	A12525/32X500
13/16	20.64	0.8126	400	460	A12513/16X500
7/8	22.22	0.8748	400	460	A1257/8X500
15/16	23.81	0.9374	400	460	A12515/16X500
1"	25.40	1.0000	400	460	A1251X500



- A976** • PFX 超长钻头
- A977** • Broca PFX Série Extra Longa
- A978** • Broca PFX Extra Larga
- PFX Extra Length Drill

A976; A977; A978	■	1.3	1.4	1.5	1.6										
	•	1.1	1.2	2.1	2.2	2.3	3.2	3.3	3.4	4.1	4.2	4.3	6.3	6.4	7.4

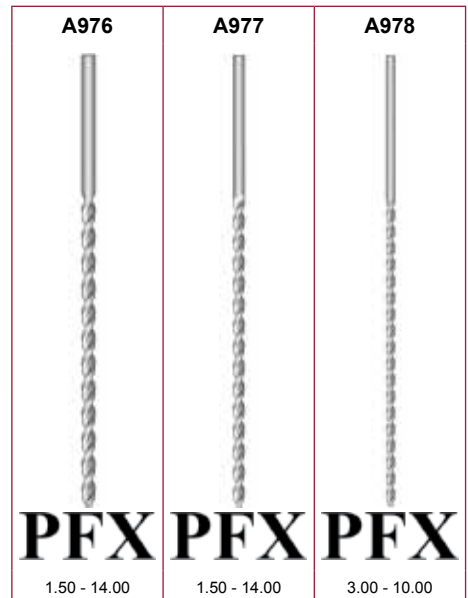

d_1 Øh ₈ Inch	d_1 Øh ₈ mm	d_1 decimal Inch	l_2 mm	l_1 mm	A976	A977	A978
	1.50	0.0591	100	150		A9771.5	²⁾
	1.50	0.0591	75	115	A9761.5		
1/16	1.59	0.0626	100	150		A9771/16	²⁾
	2.00	0.0787	110	160		A9772.0	²⁾
	2.00	0.0787	85	125	A9762.0X125		
	2.10	0.0827	85	125	A9762.1X125		
	2.20	0.0866	90	135	A9762.2X135		
	2.30	0.0906	90	135	A9762.3X135		
3/32	2.38	0.0937	115	170		A9773/32	²⁾
	2.40	0.0945	95	140	A9762.4X140		
	2.50	0.0984	95	140	A9762.5X140		
	2.60	0.1024	95	140	A9762.6X140		
	2.70	0.1063	100	150	A9762.7X150		
	2.80	0.1102	100	150	A9762.8X150		
	2.90	0.1142	100	150	A9762.9X150		
	3.00	0.1181	100	150	A9763.0X150		
	3.00	0.1181	130	190		A9773.0X190	
	3.00	0.1181	160	240			A9783.0 ²⁾
	3.10	0.1220	105	155	A9763.1X155		
1/8	3.18	0.1252	105	155	A9761/8		

²⁾ 多马公司标准 / Padrão Dormer / Norma Dormer / Dormer Standard

d_1 \varnothing_{h_8} Inch	d_1 \varnothing_{h_8} mm	d_1 decimal Inch	l_2 mm	l_1 mm	A976	A977	A978	
1/8	3.18	0.1252	135	200		A9771/8		
	3.20	0.1260	105	155	A9763.2X155			
	3.30	0.1299	105	155	A9763.3X155			
	3.40	0.1339	115	165	A9763.4X165			
	3.50	0.1378	115	165	A9763.5X165			
	3.50	0.1378	145	210		A9773.5X210		
	3.50	0.1378	180	265			A9783.5X265	
	3.60	0.1417	115	165	A9763.6X165			
	3.70	0.1457	115	165	A9763.7X165			
	3.80	0.1496	120	175	A9763.8X175			
	3.90	0.1535	120	175	A9763.9X175			
	5/32	3.97	0.1563	120	175	A9765/32		
		4.00	0.1575	120	175	A9764.0X175		
		4.00	0.1575	150	220		A9774.0X220	
4.00		0.1575	190	280			A9784.0X280	
4.10		0.1614	120	175	A9764.1X175			
4.20		0.1654	120	175	A9764.2X175			
4.30		0.1693	125	185	A9764.3X185			
4.40		0.1732	125	185	A9764.4X185			
4.50		0.1772	125	185	A9764.5X185			
4.50		0.1772	160	235		A9774.5X235		
4.50		0.1772	200	295			A9784.5X295	
4.60		0.1811	125	185	A9764.6X185			
4.70		0.1850	125	185	A9764.7X185			
3/16		4.76	0.1874	135	195	A9763/16		
3/16	4.76	0.1874	170	245		A9773/16		
	4.80	0.1890	135	195	A9764.8X195			
	4.90	0.1929	135	195	A9764.9X195			
	5.00	0.1969	135	195	A9765.0X195			
	5.00	0.1969	170	245		A9775.0X245		
	5.00	0.1969	210	315			A9785.0X315	
	5.10	0.2008	135	195	A9765.1X195			
	5.20	0.2047	135	195	A9765.2X195			
	5.30	0.2087	135	195	A9765.3X195			
	5.40	0.2126	140	205	A9765.4X205			
	5.50	0.2165	140	205	A9765.5X205			
	5.50	0.2165	180	260		A9775.5X260		
	5.50	0.2165	225	330			A9785.5X330	
	5.60	0.2205	140	205	A9765.6X205			
5.70	0.2244	140	205	A9765.7X205				
5.80	0.2283	140	205	A9765.8X205				
5.90	0.2323	140	205	A9765.9X205				
6.00	0.2362	140	205	A9766.0X205				
6.00	0.2362	180	260		A9776.0X260			
6.00	0.2362	225	330			A9786.0X330		
6.10	0.2402	150	215	A9766.1X215				
6.20	0.2441	150	215	A9766.2X215				
6.30	0.2480	150	215	A9766.3X215				
1/4	6.35	0.2500	150	215	A9761/4			
1/4	6.35	0.2500	190	275		A9771/4		
	6.35	0.2500	235	350			A9781/4	
	6.40	0.2520	150	215	A9766.4X215			
	6.50	0.2559	150	215	A9766.5X215			
	6.50	0.2559	190	275		A9776.5X275		
	6.50	0.2559	235	350			A9786.5X350	
	6.60	0.2598	150	215	A9766.6X215			
	6.70	0.2638	150	215	A9766.7X215			
	6.80	0.2677	155	225	A9766.8X225			
	6.90	0.2717	155	225	A9766.9X225			
	7.00	0.2756	155	225	A9767.0X225			
	7.00	0.2756	200	290		A9777.0X290		
	7.00	0.2756	250	370			A9787.0X370	
	7.50	0.2953	155	225	A9767.5X225			
7.50	0.2953	200	290		A9777.5X290			
7.50	0.2953	250	370			A9787.5X370		
5/16	7.94	0.3126	165	240	A9765/16			
	8.00	0.3150	165	240	A9768.0X240			
	8.00	0.3150	210	305		A9778.0X305		

d_1 $\varnothing h_8$ Inch	d_1 $\varnothing h_8$ mm	d_1 decimal Inch	l_2 mm	l_1 mm	A976	A977	A978
	8.00	0.3150	265	390			A9788.0X390
	8.50	0.3346	165	240	A9768.5X240		
	8.50	0.3346	210	305		A9778.5X305	
	8.50	0.3346	265	390			A9788.5X390
11/32	8.73	0.3437	175	250	A97611/32		
11/32	8.73	0.3437	220	320		A97711/32	
	9.00	0.3543	175	250	A9769.0X250		
	9.00	0.3543	220	320		A9779.0X320	
	9.00	0.3543	280	410			A9789.0X410
	9.50	0.3740	175	250	A9769.5X250		
	9.50	0.3740	220	320		A9779.5X320	
	9.50	0.3740	280	410			A9789.5X410
3/8	9.52	0.3748	185	265	A9763/8		
	10.00	0.3937	185	265	A97610.0X265		
	10.00	0.3937	235	340		A97710.0X340	
	10.00	0.3937	295	430			A97810.0X430
	10.50	0.4134	185	265	A97610.5		
	10.50	0.4134	235	340		A97710.5	
	11.00	0.4331	195	280	A97611.0		
	11.00	0.4331	250	365		A97711.0	
7/16	11.11	0.4374	195	280	A9767/16		
	11.50	0.4528	195	280	A97611.5		
	11.50	0.4528	250	365		A97711.5	
	12.00	0.4724	205	295	A97612.0		
	12.00	0.4724	260	375		A97712.0	
	12.50	0.4921	205	295	A97612.5		
	12.50	0.4921	260	375		A97712.5	
1/2	12.70	0.5000	205	295	A9761/2		
	13.00	0.5118	205	295	A97613.0		
	13.00	0.5118	260	375		A97713.0	
	14.00	0.5512	215	310	A97614.0	²⁾	
	14.00	0.5512	270	390		A97714.0	²⁾



A130

- 锥柄钻头
- Broca de Haste Cônica
- Broca de mango cónico
- Taper Shank Drill

大于 14.0 mm 作心厚减薄
 Acima de 14.0 mm - Ponta adelgada
 Por encima de 14,0mm-Punta adelgazada
 Above 14.0mm - Point Thinned

A530

- 锥柄钻头
- Broca de Haste Cônica
- Broca de mango cónico
- Taper Shank Drill

A730

A130	■	1.1	1.2	1.3	1.4	3.1	3.2														
	•	1.5	1.6	2.1	2.2	2.3	3.3	3.4	4.1	4.2	4.3	5.1	5.2	5.3	6.1	6.2	6.3	6.4	7.1	7.2	7.3
		7.4	8.1	8.2	8.3	9.1															
A530	■	1.1	1.2	1.3	1.4	3.2	3.3	6.3													
	•	1.5	1.6	2.1	2.2	2.3	3.1	3.4	4.1	4.2	4.3	5.1	5.2	5.3	6.1	6.2	6.4	7.1	7.2	7.3	7.4
		8.1	8.2	8.3	9.1																
A730	■	1.5	1.6	2.2	2.3	3.4															
	•	1.1	1.2	1.3	1.4	2.1	3.1	3.2	3.3	4.1	4.2	4.3	5.1	5.2	5.3	6.1	6.2	6.3	6.4	7.1	7.2
		7.3	7.4	8.1	8.2	8.3	9.1														



d_1 $\varnothing h_8$ Inch	d_1 $\varnothing h_8$ mm	d_1 decimal Inch	l_2 mm	l_1 mm	MK	A130	A530	A730
	2.00	0.0787	24	105	1	A1302.0		
	2.50	0.0984	30	111	1	A1302.5		
	3.00	0.1181	33	114	1	A1303.0		
1/8	3.18	0.1252	36	117	1	A1301/8		
	3.20	0.1260	36	117	1	A1303.2		
	3.25	0.1280	36	117	1	A1303.25		
	3.30	0.1299	36	117	1	A1303.3		
	3.50	0.1378	39	120	1	A1303.5		
9/64	3.57	0.1406	39	120	1	A1309/64		
	3.75	0.1476	39	120	1	A1303.75		
5/32	3.97	0.1563	43	124	1	A1305/32		
	4.00	0.1575	43	124	1	A1304.0		

d_1 $\varnothing h_8$ Inch	d_1 $\varnothing h_8$ mm	d_1 decimal Inch	l_2 mm	l_1 mm	MK	A130	A530	A730
	4.10	0.1614	43	124	1	A1304.1		
	4.20	0.1654	43	124	1	A1304.2		
	4.25	0.1673	43	124	1	A1304.25		
11/64	4.37	0.1720	47	128	1	A13011/64		
	4.50	0.1772	47	128	1	A1304.5		
	4.75	0.1870	52	128	1	A1304.75		
3/16	4.76	0.1874	52	133	1	A1303/16		
	4.80	0.1890	52	133	1	A1304.8		
	4.90	0.1929	52	133	1	A1304.9		
	5.00	0.1969	52	133	1	A1305.0		
	5.10	0.2008	52	133	1	A1305.1		
13/64	5.16	0.2031	52	133	1	A13013/64		
	5.20	0.2047	52	133	1	A1305.2		
	5.25	0.2067	52	133	1	A1305.25		
	5.40	0.2126	57	138	1	A1305.4		
	5.50	0.2165	57	138	1	A1305.5		
7/32	5.56	0.2189	57	138	1	A1307/32		
	5.70	0.2244	57	138	1	A1305.7		
	5.75	0.2264	57	138	1	A1305.75		
	5.80	0.2283	57	138	1	A1305.8		
	5.90	0.2323	57	138	1	A1305.9		
15/64	5.95	0.2343	57	138	1	A13015/64		
	6.00	0.2362	57	138	1	A1306.0		
	6.10	0.2402	63	144	1	A1306.1		
	6.20	0.2441	63	144	1	A1306.2		
	6.25	0.2461	63	144	1	A1306.25		
	6.30	0.2480	63	144	1	A1306.3		
1/4	6.35	0.2500	63	144	1	A1301/4		
	6.40	0.2520	63	144	1	A1306.4		
	6.50	0.2559	63	144	1	A1306.5		
	6.60	0.2598	63	144	1	A1306.6		
	6.70	0.2638	63	144	1	A1306.7		
17/64	6.75	0.2657	69	150	1	A13017/64		
	6.75	0.2657	69	150	1	A1306.75		
	6.80	0.2677	69	150	1	A1306.8		
	6.90	0.2717	69	150	1	A1306.9		
	7.00	0.2756	69	150	1	A1307.0		
9/32	7.14	0.2811	69	150	1	A1309/32		
	7.20	0.2835	69	150	1	A1307.2		
	7.25	0.2854	69	150	1	A1307.25		
	7.30	0.2874	69	150	1	A1307.3		
	7.40	0.2913	69	150	1	A1307.4		
	7.50	0.2953	69	150	1	A1307.5		
19/64	7.54	0.2969	75	156	1	A13019/64		
	7.70	0.3031	75	156	1	A1307.7		
	7.75	0.3051	75	156	1	A1307.75		
	7.80	0.3071	75	156	1	A1307.8		
	7.90	0.3110	75	156	1	A1307.9		
5/16	7.94	0.3126	75	156	1	A1305/16		
	8.00	0.3150	75	156	1	A1308.0		
	8.10	0.3189	75	156	1	A1308.1		
	8.20	0.3228	75	156	1	A1308.2		
	8.25	0.3248	75	156	1	A1308.25		
	8.30	0.3268	75	156	1	A1308.3		
21/64	8.33	0.3280	75	156	1	A13021/64		
	8.40	0.3307	75	156	1	A1308.4		
	8.50	0.3346	75	156	1	A1308.5	A5308.5	
	8.60	0.3386	81	162	1	A1308.6		
	8.70	0.3425	81	162	1	A1308.7		
11/32	8.73	0.3437	81	162	1	A13011/32		
	8.75	0.3445	81	162	1	A1308.75		
	8.80	0.3465	81	162	1	A1308.8		
	8.90	0.3504	81	162	1	A1308.9		
	9.00	0.3543	81	162	1	A1309.0	A5309.0	
	9.10	0.3583	81	162	1	A1309.1		
23/64	9.13	0.3594	81	162	1	A13023/64		
	9.20	0.3622	81	162	1	A1309.2		
	9.25	0.3642	81	162	1	A1309.25		
	9.30	0.3661	81	162	1	A1309.3		
	9.50	0.3740	81	162	1	A1309.5		

d_1 $\varnothing h_8$ Inch	d_1 $\varnothing h_8$ mm	d_1 decimal Inch	l_2 mm	l_1 mm	MK	A130	A530	A730
3/8	9.52	0.3748	87	168	1	A1303/8		
	9.60	0.3780	87	168	1	A1309.6		
	9.70	0.3819	87	168	1	A1309.7		
	9.75	0.3839	87	168	1	A1309.75		
	9.80	0.3858	87	168	1	A1309.8		
25/64	9.90	0.3898	87	168	1	A1309.9		
	9.92	0.3906	87	168	1	A13025/64		
	10.00	0.3937	87	168	1	A13010.0	A53010.0	A73010.0
	10.10	0.3976	87	168	1	A13010.1		
	10.20	0.4016	87	168	1	A13010.2	A53010.2	A73010.2
13/32	10.25	0.4035	87	168	1	A13010.25		
	10.30	0.4055	87	168	1	A13010.3		
	10.32	0.4063	87	168	1	A13013/32		
	10.50	0.4134	87	168	1	A13010.5	A53010.5	A73010.5
	27/64	10.72	0.4220	94	175	1	A13027/64	
10.75		0.4232	94	175	1	A13010.75		
10.80		0.4252	94	175	1	A13010.8		A73010.8
10.90		0.4291	94	175	1	A13010.9		
11.00		0.4331	94	175	1	A13011.0	A53011.0	A73011.0
7/16	11.10	0.4370	94	175	1	A13011.1		
	11.11	0.4374	94	175	1	A1307/16		
	11.20	0.4409	94	175	1	A13011.2		
	11.25	0.4429	94	175	1	A13011.25		
	11.30	0.4449	94	175	1	A13011.3		
29/64	11.40	0.4488	94	175	1	A13011.4		
	11.50	0.4528	94	175	1	A13011.5	A53011.5	A73011.5
	11.51	0.4531	94	175	1	A13029/64		
	11.60	0.4567	94	175	1	A13011.6		
	11.70	0.4606	94	175	1	A13011.7		
15/32	11.75	0.4626	94	175	1	A13011.75	A53011.75	
	11.80	0.4646	94	175	1	A13011.8		A73011.8
	11.90	0.4685	101	182	1	A13011.9		
	11.91	0.4689	101	182	1	A13015/32		
	12.00	0.4724	101	182	1	A13012.0	A53012.0	A73012.0
31/64	12.10	0.4764	101	182	1	A13012.1		
	12.20	0.4803	101	182	1	A13012.2		A73012.2
	12.25	0.4823	101	182	1	A13012.25		
	12.30	0.4843	101	182	1	A13012.3		
	12.30	0.4843	101	182	1	A13031/64		
1/2	12.40	0.4882	101	182	1	A13012.4		
	12.50	0.4921	101	182	1	A13012.5	A53012.5	A73012.5
	12.60	0.4961	101	182	1	A13012.6		
	12.70	0.5000	101	182	1	A13012.7		
	12.70	0.5000	101	182	1	A1301/2		
33/64	12.75	0.5020	101	182	1	A13012.75		
	12.80	0.5039	101	182	1	A13012.8		A73012.8
	12.90	0.5079	101	182	1	A13012.9		
	13.00	0.5118	101	182	1	A13013.0	A53013.0	A73013.0
	13.10	0.5157	101	182	1	A13033/64		
17/32	13.20	0.5197	101	182	1	A13013.2		
	13.25	0.5217	108	189	1	A13013.25		
	13.49	0.5311	108	189	1	A13017/32		
	13.50	0.5315	108	189	1	A13013.5	A53013.5	A73013.5
	13.60	0.5354	108	189	1	A13013.6		
35/64	13.70	0.5394	108	189	1	A13013.7		
	13.75	0.5413	108	189	1	A13013.75		
	13.80	0.5433	108	189	1	A13013.8		A73013.8
	13.89	0.5469	108	189	1	A13035/64		
	13.90	0.5472	108	189	1	A13013.9		
9/16	14.00	0.5512	108	189	1	A13014.0	A53014.0	A73014.0
	14.10	0.5551	114	212	2	A13014.1		
	14.20	0.5591	114	212	2	A13014.2		
	14.25	0.5610	114	212	2	A13014.25		A73014.25
	14.29	0.5626	114	212	2	A1309/16		
37/64	14.30	0.5630	114	212	2	A13014.3		
	14.40	0.5669	114	212	2	A13014.4		
	14.50	0.5709	114	212	2	A13014.5	A53014.5	A73014.5
	14.60	0.5748	114	212	2	A13014.6		
	14.68	0.5780	114	212	2	A13037/64		
	14.70	0.5787	114	212	2	A13014.7		

d_1 $\varnothing h_8$ Inch	d_1 $\varnothing h_8$ mm	d_1 decimal Inch	l_2 mm	l_1 mm	MK	A130	A530	A730
	14.75	0.5807	114	212	2	A13014.75		A73014.75
	14.80	0.5827	114	212	2	A13014.8		
	14.90	0.5866	114	212	2	A13014.9		
19/32	15.00	0.5906	114	212	2	A13015.0	A53015.0	A73015.0
	15.08	0.5937	120	218	2	A13019/32		
	15.10	0.5945	120	218	2	A13015.1		
	15.20	0.5984	120	218	2	A13015.2		
39/64	15.25	0.6004	120	218	2	A13015.25	A53015.25	A73015.25
	15.48	0.6094	120	218	2	A13039/64		
	15.50	0.6102	120	218	2	A13015.5	A53015.5	A73015.5
	15.70	0.6181	120	218	2	A13015.7		
	15.75	0.6201	120	218	2	A13015.75		A73015.75
5/8	15.80	0.6220	120	218	2	A13015.8		
	15.88	0.6252	120	218	2	A1305/8		
	15.90	0.6260	120	218	2	A13015.9		
	16.00	0.6299	120	218	2	A13016.0	A53016.0	A73016.0
	16.10	0.6339	125	223	2	A13016.1		
	16.20	0.6378	125	223	2	A13016.2		
	16.25	0.6398	120	218	2			A73016.25
	16.25	0.6398	125	223	2	A13016.25		
41/64	16.27	0.6406	125	223	2	A13041/64		
	16.50	0.6496	125	223	2	A13016.5	A53016.5	A73016.5
21/32	16.67	0.6563	125	223	2	A13021/32		
	16.75	0.6594	125	223	2	A13016.75		
	17.00	0.6693	125	223	2	A13017.0	A53017.0	A73017.0
43/64	17.07	0.6720	130	228	2	A13043/64		
	17.25	0.6791	130	228	2	A13017.25		A73017.25
11/16	17.46	0.6874	130	228	2	A13011/16		
	17.50	0.6890	130	228	2	A13017.5	A53017.5	A73017.5
	17.75	0.6988	130	228	2	A13017.75		A73017.75
45/64	17.86	0.7031	130	228	2	A13045/64		
	18.00	0.7087	130	228	2	A13018.0	A53018.0	A73018.0
	18.25	0.7185	135	233	2	A13018.25		A73018.25
23/32	18.26	0.7189	135	233	2	A13023/32		
	18.50	0.7283	135	233	2	A13018.5	A53018.5	A73018.5
47/64	18.65	0.7343	135	233	2	A13047/64		
	18.75	0.7382	135	233	2	A13018.75		A73018.75
	19.00	0.7480	135	233	2	A13019.0	A53019.0	A73019.0
3/4	19.05	0.7500	140	238	2	A1303/4		
	19.25	0.7579	140	238	2	A13019.25		A73019.25
49/64	19.45	0.7657	140	238	2	A13049/64		
	19.50	0.7677	140	238	2	A13019.5	A53019.5	A73019.5
	19.75	0.7776	140	238	2	A13019.75		A73019.75
25/32	19.84	0.7811	140	238	2	A13025/32		
	20.00	0.7874	140	238	2	A13020.0	A53020.0	A73020.0
51/64	20.24	0.7969	145	243	2	A13051/64		
	20.25	0.7972	145	243	2	A13020.25		A73020.25
	20.40	0.8031	145	243	2	A13020.4		
	20.50	0.8071	145	243	2	A13020.5	A53020.5	A73020.5
13/16	20.64	0.8126	145	243	2	A13013/16		
	20.75	0.8169	145	243	2	A13020.75		A73020.75
	21.00	0.8268	145	243	2	A13021.0	A53021.0	A73021.0
53/64	21.03	0.8280	145	243	2	A13053/64		
	21.25	0.8366	150	248	2	A13021.25		
27/32	21.43	0.8437	150	248	2	A13027/32		
	21.50	0.8465	150	248	2	A13021.5	A53021.5	A73021.5
	21.75	0.8563	150	248	2	A13021.75		
55/64	21.83	0.8594	150	248	2	A13055/64		
	22.00	0.8661	150	248	2	A13022.0	A53022.0	A73022.0
7/8	22.22	0.8748	150	248	2	A1307/8		
	22.25	0.8760	150	248	2	A13022.25		
	22.50	0.8858	155	253	2	A13022.5	A53022.5	A73022.5
57/64	22.62	0.8906	155	253	2	A13057/64		
	22.75	0.8957	155	253	2	A13022.75		
	23.00	0.9055	155	253	2	A13023.0	A53023.0	A73023.0
29/32	23.02	0.9063	155	253	2	A13029/32		
	23.25	0.9154	155	276	3	A13023.25		
59/64	23.42	0.9220	155	276	3	A13059/64		
	23.50	0.9252	155	276	3	A13023.5	A53023.5	A73023.5
	23.75	0.9350	160	281	3	A13023.75		

d_1 $\varnothing h_8$ Inch	d_1 $\varnothing h_8$ mm	d_1 decimal Inch	l_2 mm	l_1 mm	MK	A130	A530	A730
15/16	23.81	0.9374	160	281	3	A13015/16		
	24.00	0.9449	160	281	3	A13024.0	A53024.0	A73024.0
61/64	24.21	0.9531	160	281	3	A13061/64		
	24.25	0.9547	160	281	3	A13024.25		
	24.50	0.9646	160	281	3	A13024.5	A53024.5	A73024.5
31/32	24.61	0.9689	160	281	3	A13031/32		
	24.75	0.9744	160	281	3	A13024.75		
	25.00	0.9843	160	281	3	A13025.0	A53025.0	A73025.0
63/64	25.00	0.9843	160	286	3	A13063/64		
	25.25	0.9941	165	286	3	A13025.25		
1"	25.40	1.0000	165	286	3	A1301		
	25.50	1.0039	165	286	3	A13025.5	A53025.5	A73025.5
	25.75	1.0138	165	286	3	A13025.75		
	26.00	1.0236	165	286	3	A13026.0	A53026.0	A73026.0
	26.25	1.0335	165	286	3	A13026.25		
	26.50	1.0433	165	286	3	A13026.5	A53026.5	A73026.5
	26.75	1.0531	170	291	3	A13026.75		
1.1/16	26.99	1.0626	170	291	3	A1301.1/16		
	27.00	1.0630	170	291	3	A13027.0	A53027.0	A73027.0
	27.25	1.0728	170	291	3	A13027.25		
	27.50	1.0827	170	291	3	A13027.5	A53027.5	A73027.5
	27.75	1.0925	170	291	3	A13027.75		
	28.00	1.1024	170	291	3	A13028.0	A53028.0	A73028.0
	28.25	1.1122	175	296	3	A13028.25		
	28.50	1.1220	175	296	3	A13028.5	A53028.5	A73028.5
1.1/8	28.58	1.1252	175	296	3	A1301.1/8		
	28.75	1.1319	175	296	3	A13028.75		
	29.00	1.1417	175	296	3	A13029.0	A53029.0	A73029.0
	29.25	1.1516	175	296	3	A13029.25		
1.5/32	29.37	1.1563	175	296	3	A1301.5/32		
	29.50	1.1614	175	296	3	A13029.5	A53029.5	
	29.75	1.1713	175	296	3	A13029.75		
	30.00	1.1811	175	296	3	A13030.0	A53030.0	A73030.0
1.3/16	30.16	1.1874	180	301	3	A1301.3/16		
	30.25	1.1909	180	301	3	A13030.25		
	30.50	1.2008	180	301	3	A13030.5		
	30.75	1.2106	180	301	3	A13030.75		
1.7/32	30.96	1.2189	180	301	3	A1301.7/32		
	31.00	1.2205	180	301	3	A13031.0	A53031.0	A73031.0
	31.25	1.2303	180	301	3	A13031.25		
	31.50	1.2402	180	301	3	A13031.5		
	31.75	1.2500	185	306	3	A13031.75		
1.1/4	31.75	1.2500	185	306	3	A1301.1/4		
	32.00	1.2598	185	334	4	A13032.0	A53032.0	A73032.0
	32.50	1.2795	185	334	4	A13032.5		
1.9/32	32.54	1.2811	185	334	4	A1301.9/32		
	33.00	1.2992	185	334	4	A13033.0	A53033.0	
1.5/16	33.34	1.3126	185	334	4	A1301.5/16		
	33.50	1.3189	185	334	4	A13033.5		
	34.00	1.3386	190	339	4	A13034.0		
1.11/32	34.13	1.3437	190	339	4	A1301.11/32		
	34.50	1.3583	190	339	4	A13034.5		
1.3/8	34.93	1.3752	190	339	4	A1301.3/8		
	35.00	1.3780	190	339	4	A13035.0	A53035.0	
	35.50	1.3976	190	339	4	A13035.5		
1.13/32	35.72	1.4063	195	344	4	A1301.13/32		
	36.00	1.4173	195	344	4	A13036.0		
	36.50	1.4370	195	344	4	A13036.5		
1.7/16	36.51	1.4374	195	344	4	A1301.7/16		
	37.00	1.4567	195	344	4	A13037.0		
	37.50	1.4764	195	344	4	A13037.5		
	38.00	1.4961	200	349	4	A13038.0		
1.1/2	38.10	1.5000	200	349	4	A1301.1/2		
	38.50	1.5157	200	349	4	A13038.5		
	39.00	1.5354	200	349	4	A13039.0		
	39.50	1.5551	200	349	4	A13039.5		
1.9/16	39.69	1.5626	200	349	4	A1301.9/16		
	40.00	1.5748	200	349	4	A13040.0	A53040.0	
	40.50	1.5945	205	354	4	A13040.5		
	41.00	1.6142	205	354	4	A13041.0		

d_1 $\varnothing h_8$ Inch	d_1 $\varnothing h_8$ mm	d_1 decimal Inch	l_2 mm	l_1 mm	MK	A130	A530	A730	
1.5/8	41.28	1.6252	205	354	4	A1301.5/8			
	41.50	1.6339	205	354	4	A13041.5			
	42.00	1.6535	205	354	4	A13042.0			
	42.50	1.6732	205	354	4	A13042.5			
1.11/16	42.86	1.6874	210	359	4	A1301.11/16			
	43.00	1.6929	210	359	4	A13043.0			
	43.50	1.7126	210	359	4	A13043.5			
	44.00	1.7323	210	359	4	A13044.0			
1.3/4	44.45	1.7500	210	359	4	A1301.3/4			
	44.50	1.7520	210	359	4	A13044.5			
	45.00	1.7717	210	359	4	A13045.0			
	45.50	1.7913	215	364	4	A13045.5			
	46.00	1.8110	215	364	4	A13046.0			
	46.50	1.8307	215	364	4	A13046.5			
	47.00	1.8504	215	364	4	A13047.0			
	47.50	1.8701	215	364	4	A13047.5			
	48.00	1.8898	220	369	4	A13048.0			
	48.50	1.9094	220	369	4	A13048.5			
	49.00	1.9291	220	369	4	A13049.0			
	49.50	1.9488	220	369	4	A13049.5			
	50.00	1.9685	220	369	4	A13050.0			
	2"	50.80	2.0000	225	374	4	A1302		
		51.00	2.0079	225	412	5	A13051.0		
		52.00	2.0472	225	412	5	A13052.0		
53.00		2.0866	225	412	5	A13053.0			
54.00		2.1260	230	417	5	A13054.0			
55.00		2.1654	230	417	5	A13055.0			
56.00		2.2047	230	417	5	A13056.0			
57.00		2.2441	235	422	5	A13057.0			
58.00		2.2835	235	422	5	A13058.0			
59.00		2.3228	235	422	5	A13059.0			
60.00		2.3622	235	422	5	A13060.0			
61.00		2.4016	240	427	5	A13061.0			
62.00		2.4409	240	427	5	A13062.0			
63.00		2.4803	240	427	5	A13063.0			
2.1/2	63.50	2.5000	245	432	5	A1302.1/2			
	64.00	2.5197	245	432	5	A13064.0			
	65.00	2.5591	245	432	5	A13065.0			
	66.00	2.5984	245	432	5	A13066.0			
2.5/8	66.68	2.6252	245	432	5	A1302.5/8			
	67.00	2.6378	245	432	5	A13067.0			
	68.00	2.6772	250	437	5	A13068.0			
	69.00	2.7165	250	437	5	A13069.0			
2.3/4	69.85	2.7500	250	437	5	A1302.3/4			
	70.00	2.7559	250	437	5	A13070.0			
	71.00	2.7953	250	437	5	A13071.0			
	72.00	2.8346	255	442	5	A13072.0			
2.7/8	73.00	2.8740	255	442	5	A13073.0			
	73.03	2.8752	255	442	5	A1302.7/8			
	74.00	2.9134	255	442	5	A13074.0			
	75.00	2.9528	255	442	5	A13075.0			
	76.00	2.9921	260	447	5	A13076.0			
3"	76.20	3.0000	260	447	5	A1303			
	77.00	3.0315	260	514	6	A13077.0			
	78.00	3.0709	260	514	6	A13078.0			
	79.00	3.1102	260	514	6	A13079.0			
	80.00	3.1496	260	514	6	A13080.0			
	81.00	3.1890	265	519	6	A13081.0			
	84.00	3.3071	265	519	6	A13084.0			
	85.00	3.3465	265	519	6	A13085.0			
	90.00	3.5433	270	524	6	A13090.0			
	95.00	3.7402	275	529	6	A13095.0			
	100.00	3.9370	280	534	6	A130100.0			

A166



A166

- 锥柄钻头
- Broca de Haste Cônica
- Broca de mango cónico
- Taper Shank Drill

A166	▪	3.1	3.2	3.3	3.4																
	•	1.1	1.2	1.3	1.4	1.5	1.6	2.1	2.2	2.3	4.1	4.2	4.3	5.1	5.2	5.3	6.1	6.2	6.3	6.4	7.1
		7.2	7.3	7.4	8.2	9.1															



d_1 $\varnothing h_8$ mm	d_1 decimal Inch	l_2 mm	l_1 mm	MK	A166
10.00	0.3937	87	168	1	A16610.0
10.50	0.4134	87	168	1	A16610.5
11.00	0.4331	94	175	1	A16611.0
11.50	0.4528	94	175	1	A16611.5
12.00	0.4724	101	182	1	A16612.0
13.00	0.5118	101	182	1	A16613.0
13.50	0.5315	108	189	1	A16613.5
14.00	0.5512	108	189	1	A16614.0
15.00	0.5906	114	212	2	A16615.0
16.00	0.6299	120	218	2	A16616.0
17.00	0.6693	125	223	2	A16617.0
17.50	0.6890	130	228	2	A16617.5
18.00	0.7087	130	228	2	A16618.0
19.00	0.7480	135	233	2	A16619.0
20.00	0.7874	140	238	2	A16620.0
21.00	0.8268	145	243	2	A16621.0
22.00	0.8661	150	248	2	A16622.0
22.50	0.8858	155	253	2	A16622.5
23.00	0.9055	155	253	2	A16623.0
24.00	0.9449	160	281	3	A16624.0
25.00	0.9843	160	281	3	A16625.0
26.00	1.0236	165	286	3	A16626.0
27.00	1.0630	170	291	3	A16627.0
28.00	1.1024	170	291	3	A16628.0
29.00	1.1417	175	296	3	A16629.0
30.00	1.1811	175	296	3	A16630.0
32.00	1.2598	185	334	4	A16632.0
33.00	1.2992	185	334	4	A16633.0

A350

HSS

DIN
341

6XD



- 长系列锥柄钻
- Broca de Haste Cônica Série Longa
- Broca de mango cónico, serie larga
- Long Series Taper Shank Drill

A350

A350	▪	1.1	1.2																		
	•	1.3	1.4	1.5	1.6	2.1	2.2	2.3	3.1	3.2	3.3	3.4	4.1	4.2	4.3	5.1	5.2	5.3	6.1	6.2	6.3
		6.4	7.1	7.2	7.3	7.4	8.1	8.2	8.3	9.1											



A350



5.00 - 50.00

d ₁ Øh ₈ mm	d ₁ decimal Inch	l ₂ mm	l ₁ mm	MK	A350
5.00	0.1969	74	155	1	A3505.0
5.50	0.2165	80	161	1	A3505.5
6.00	0.2362	80	161	1	A3506.0
6.70	0.2638	86	167	1	A3506.7
6.80	0.2677	93	174	1	A3506.8
7.00	0.2756	93	174	1	A3507.0
7.50	0.2953	93	174	1	A3507.5
8.00	0.3150	100	181	1	A3508.0
8.40	0.3307	100	181	1	A3508.4
8.50	0.3346	100	181	1	A3508.5
8.75	0.3445	107	188	1	A3508.75
9.00	0.3543	107	188	1	A3509.0
9.50	0.3740	107	188	1	A3509.5
9.80	0.3858	116	197	1	A3509.8
10.00	0.3937	116	197	1	A35010.0
10.20	0.4016	116	197	1	A35010.2
10.50	0.4134	116	197	1	A35010.5
10.70	0.4213	125	206	1	A35010.7
11.00	0.4331	125	206	1	A35011.0
11.50	0.4528	125	206	1	A35011.5
11.75	0.4626	125	206	1	A35011.75
11.80	0.4646	125	206	1	A35011.8
12.00	0.4724	134	215	1	A35012.0
12.50	0.4921	134	215	1	A35012.5
13.00	0.5118	134	215	1	A35013.0
13.50	0.5315	142	223	1	A35013.5
14.00	0.5512	142	223	1	A35014.0
14.25	0.5610	147	245	2	A35014.25
14.50	0.5709	147	245	2	A35014.5
14.75	0.5807	147	245	2	A35014.75
15.00	0.5906	147	245	2	A35015.0
15.25	0.6004	153	251	2	A35015.25
15.50	0.6102	153	251	2	A35015.5
15.75	0.6201	153	251	2	A35015.75

d_1 $\varnothing h_8$ mm	d_1 decimal Inch	l_2 mm	l_1 mm	MK	A350
16.00	0.6299	153	251	2	A35016.0
16.25	0.6398	159	257	2	A35016.25
16.50	0.6496	159	257	2	A35016.5
16.75	0.6594	159	257	2	A35016.75
17.00	0.6693	159	257	2	A35017.0
17.25	0.6791	165	263	2	A35017.25
17.50	0.6890	165	263	2	A35017.5
18.00	0.7087	165	263	2	A35018.0
18.50	0.7283	171	269	2	A35018.5
19.00	0.7480	171	269	2	A35019.0
19.50	0.7677	177	275	2	A35019.5
19.75	0.7776	177	275	2	A35019.75
20.00	0.7874	177	275	2	A35020.0
20.25	0.7972	184	282	2	A35020.25
20.50	0.8071	184	282	2	A35020.5
21.00	0.8268	184	282	2	A35021.0
21.50	0.8465	191	289	2	A35021.5
22.00	0.8661	191	289	2	A35022.0
22.50	0.8858	198	296	2	A35022.5
23.00	0.9055	198	296	2	A35023.0
23.50	0.9252	198	319	3	A35023.5
24.00	0.9449	206	327	3	A35024.0
24.50	0.9646	206	327	3	A35024.5
25.00	0.9843	206	327	3	A35025.0
25.50	1.0039	214	335	3	A35025.5
26.00	1.0236	214	335	3	A35026.0
26.50	1.0433	214	335	3	A35026.5
27.00	1.0630	222	343	3	A35027.0
27.50	1.0827	222	343	3	A35027.5
28.00	1.1024	222	343	3	A35028.0
29.00	1.1417	230	351	3	A35029.0
30.00	1.1811	230	351	3	A35030.0
30.50	1.2008	239	360	3	A35030.5
31.00	1.2205	239	360	3	A35031.0
31.50	1.2402	239	360	3	A35031.5
32.00	1.2598	248	397	4	A35032.0
33.00	1.2992	248	397	4	A35033.0
34.00	1.3386	257	406	4	A35034.0
35.00	1.3780	257	406	4	A35035.0
36.00	1.4173	267	416	4	A35036.0
37.00	1.4567	267	416	4	A35037.0
38.00	1.4961	277	426	4	A35038.0
39.00	1.5354	277	426	4	A35039.0
40.00	1.5748	277	426	4	A35040.0
41.00	1.6142	287	436	4	A35041.0
42.00	1.6535	287	436	4	A35042.0
43.00	1.6929	298	447	4	A35043.0
44.00	1.7323	298	447	4	A35044.0
45.00	1.7717	298	447	4	A35045.0
46.00	1.8110	310	459	4	A35046.0
47.00	1.8504	310	459	4	A35047.0
48.00	1.8898	321	470	4	A35048.0
50.00	1.9685	321	470	4	A35050.0

A345



A345

- 莫氏锥柄 超长钻头
- Broca de Haste Cônica Série Extra Longa
- Broca serie extra larga
- Morse Taper Shank Extra Length Drill

A345	▪	1.1	1.2																		
	•	1.3	1.4	1.5	1.6	2.1	2.2	2.3	3.1	3.2	3.3	3.4	4.1	4.2	4.3	5.1	5.2	5.3	6.1	6.2	6.3
		6.4	7.1	7.2	7.3	7.4	8.1	8.2	8.3	9.1											



8.00 - 50.00

d_1 $\varnothing h_8$ Inch	d_1 $\varnothing h_8$ mm	d_1 decimal Inch	l_2 mm	l_1 mm	MK	A345
	8.00	0.3150	165	265	1	A3458.0
	8.50	0.3346	165	265	1	A3458.5
	9.00	0.3543	175	275	1	A3459.0
	9.50	0.3740	175	275	1	A3459.5
3/8	9.52	0.3748	185	285	1	A3453/8
	10.00	0.3937	185	285	1	A34510.0
13/32	10.32	0.4063	185	285	1	A34513/32
	10.50	0.4134	185	285	1	A34510.5
	11.00	0.4331	195	300	1	A34511.0
7/16	11.11	0.4374	195	300	1	A3457/16
	11.50	0.4528	195	300	1	A34511.5
29/64	11.51	0.4531	205	310	1	A34529/64
	12.00	0.4724	205	310	1	A34512.0
	12.50	0.4921	205	310	1	A34512.5
1/2	12.70	0.5000	205	310	1	A3451/2
	13.00	0.5118	205	310	1	A34513.0
17/32	13.49	0.5311	220	325	1	A34517/32
	13.50	0.5315	220	325	1	A34513.5
	14.00	0.5512	220	325	1	A34514.0
9/16	14.29	0.5626	220	340	2	A3459/16
37/64	14.68	0.5780	220	340	2	A34537/64
	15.00	0.5906	220	340	2	A34515.0
39/64	15.48	0.6094	230	355	2	A34539/64
	15.50	0.6102	230	355	2	A34515.5
5/8	15.88	0.6252	230	355	2	A3455/8
	16.00	0.6299	230	355	2	A34516.0
41/64	16.27	0.6406	230	355	2	A34541/64
	16.50	0.6496	230	355	2	A34516.5
21/32	16.67	0.6563	230	355	2	A34521/32
	17.00	0.6693	230	355	2	A34517.0
11/16	17.46	0.6874	245	370	2	A34511/16
	17.50	0.6890	245	370	2	A34517.5

d_1 \varnothing_{h_8} Inch	d_1 \varnothing_{h_8} mm	d_1 decimal Inch	l_2 mm	l_1 mm	MK	A345
	18.00	0.7087	245	370	2	A34518.0
	18.50	0.7283	245	370	2	A34518.5
	19.00	0.7480	245	370	2	A34519.0
3/4	19.05	0.7500	260	385	2	A3453/4
	19.50	0.7677	260	385	2	A34519.5
	20.00	0.7874	260	385	2	A34520.0
	20.50	0.8071	260	385	2	A34520.5
	21.00	0.8268	260	385	2	A34521.0
	21.50	0.8465	270	405	2	A34521.5
	22.00	0.8661	270	405	2	A34522.0
7/8	22.22	0.8748	270	405	2	A3457/8
	22.50	0.8858	270	405	3	A34522.5
	23.00	0.9055	270	405	3	A34523.0
	23.50	0.9252	270	425	3	A34523.5
	24.00	0.9449	290	440	3	A34524.0
	24.50	0.9646	290	440	3	A34524.5
	25.00	0.9843	290	440	3	A34525.0
1"	25.40	1.0000	290	440	3	A3451 ¹⁾
	25.50	1.0039	290	440	3	A34525.5 ¹⁾
	26.00	1.0236	290	440	3	A34526.0 ¹⁾
	26.50	1.0433	290	440	3	A34526.5 ¹⁾
	27.00	1.0630	305	460	3	A34527.0 ¹⁾
	28.00	1.1024	305	460	3	A34528.0 ¹⁾
	29.00	1.1417	305	460	3	A34529.0 ¹⁾
	30.00	1.1811	305	460	3	A34530.0 ¹⁾
1.1/4	31.75	1.2500	320	480	3	A3451.1/4 ¹⁾
	31.00	1.2205	320	480	3	A34531.0 ¹⁾
	32.00	1.2598	320	505	4	A34532.0 ¹⁾
	33.00	1.2992	320	505	4	A34533.0 ¹⁾
	34.00	1.3386	340	530	4	A34534.0 ¹⁾
	35.00	1.3780	340	530	4	A34535.0 ¹⁾
	36.00	1.4173	340	530	4	A34536.0 ¹⁾
	37.00	1.4567	340	530	4	A34537.0 ¹⁾
	38.00	1.4961	360	555	4	A34538.0 ¹⁾
1.1/2	38.10	1.5000	360	555	4	A3451.1/2 ¹⁾
	39.00	1.5354	360	555	4	A34539.0 ¹⁾
	40.00	1.5748	360	555	4	A34540.0 ¹⁾
	41.00	1.6142	360	555	4	A34541.0 ¹⁾
	42.00	1.6535	360	555	4	A34542.0 ¹⁾
1.3/4	44.45	1.7500	385	585	4	A3451.3/4 ¹⁾
	45.00	1.7717	385	585	4	A34545.0 ¹⁾
	48.00	1.8898	405	605	4	A34548.0 ¹⁾
	50.00	1.9685	405	605	4	A34550.0 ¹⁾

¹⁾ < 10xD



- A951**
- 莫氏锥柄 超长钻头
 - Broca de Haste Cônica Série Extra Longa
- A952**
- Broca serie extra larga
 - Morse Taper Shank Extra Length Drill

A951; A952	■	1.1	1.2	1.3																
	•	1.4	1.5	1.6	2.1	2.2	2.3	3.1	3.2	3.3	3.4	4.1	4.2	4.3	5.1	5.2	5.3	6.1	6.2	
		6.3	6.4	7.1	7.2	7.3	7.4	8.1	8.2	8.3	9.1									

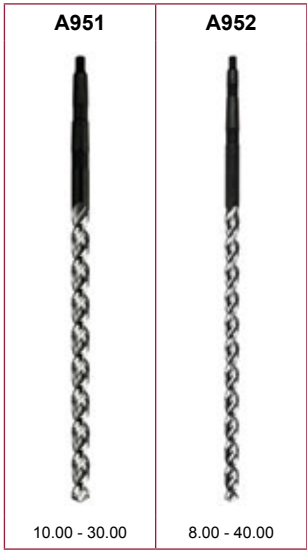

d_1 $\varnothing h_8$ mm	d_1 decimal Inch	l_2 mm	l_1 mm	MK	A951	A952
8.00	0.3150	210	330	1		A9528.0
8.50	0.3346	210	330	1		A9528.5
9.00	0.3543	220	345	1		A9529.0
10.00	0.3937	185	285	1	A95110.0	
10.00	0.3937	235	360	1		A95210.0
10.50	0.4134	235	360	1		A95210.5
11.00	0.4331	195	300	1	A95111.0	
11.00	0.4331	250	375	1		A95211.0
11.50	0.4528	250	375	1		A95211.5
12.00	0.4724	205	310	1	A95112.0	
12.00	0.4724	260	395	1		A95212.0
12.50	0.4921	205	310	1	A95112.5	
12.50	0.4921	260	395	1		A95212.5
13.00	0.5118	205	310	1	A95113.0	
13.00	0.5118	260	395	1		A95213.0
13.50	0.5315	220	325	1	A95113.5	
13.50	0.5315	275	410	1		A95213.5
14.00	0.5512	220	325	1	A95114.0	
14.00	0.5512	275	410	1		A95214.0
14.50	0.5709	220	340	2	A95114.5	³⁾
14.50	0.5709	275	425	2		A95214.5 ⁴⁾
15.00	0.5906	220	340	2	A95115.0	³⁾
15.00	0.5906	275	425	2		A95215.0 ⁴⁾
15.50	0.6102	230	355	2	A95115.5	³⁾
15.50	0.6102	295	445	2		A95215.5 ⁴⁾
16.00	0.6299	230	355	2	A95116.0	³⁾

³⁾ < 15xD
⁴⁾ < 20xD

d_1 $\varnothing h_8$ mm	d_1 decimal Inch	l_2 mm	l_1 mm	MK	A951	A952
16.00	0.6299	295	445	2		A95216.0 ⁴⁾
16.50	0.6496	230	355	2	A95116.5 ³⁾	
16.50	0.6496	295	445	2		A95216.5 ⁴⁾
17.00	0.6693	230	355	2	A95117.0 ³⁾	
17.00	0.6693	295	445	2		A95217.0 ⁴⁾
17.50	0.6890	245	370	2	A95117.5 ³⁾	
17.50	0.6890	310	465	2		A95217.5 ⁴⁾
18.00	0.7087	245	370	2	A95118.0 ³⁾	
18.00	0.7087	310	465	2		A95218.0 ⁴⁾
18.50	0.7283	245	370	2	A95118.5 ³⁾	
18.50	0.7283	310	465	2		A95218.5 ⁴⁾
19.00	0.7480	245	370	2	A95119.0 ³⁾	
19.00	0.7480	310	465	2		A95219.0 ⁴⁾
19.50	0.7677	260	385	2	A95119.5 ³⁾	
19.50	0.7677	325	490	2		A95219.5 ⁴⁾
20.00	0.7874	260	385	2	A95120.0 ³⁾	
20.00	0.7874	325	490	2		A95220.0 ⁴⁾
21.00	0.8268	260	385	2	A95121.0 ³⁾	
21.00	0.8268	325	490	2		A95221.0 ⁴⁾
22.00	0.8661	270	405	2	A95122.0 ³⁾	
22.00	0.8661	345	515	2		A95222.0 ⁴⁾
23.00	0.9055	270	405	2	A95123.0 ³⁾	
23.00	0.9055	345	515	2		A95223.0 ⁴⁾
24.00	0.9449	290	440	3	A95124.0 ³⁾	
24.00	0.9449	365	555	3		A95224.0 ⁴⁾
25.00	0.9843	290	440	3	A95125.0 ³⁾	
25.00	0.9843	365	555	3		A95225.0 ⁴⁾
26.00	1.0236	290	440	3	A95126.0 ³⁾	
26.00	1.0236	365	555	3		A95226.0 ⁴⁾
27.00	1.0630	305	460	3	A95127.0 ³⁾	
27.00	1.0630	385	580	3		A95227.0 ⁴⁾
28.00	1.1024	305	460	3	A95128.0 ³⁾	
28.00	1.1024	385	580	3		A95228.0 ⁴⁾
29.00	1.1417	305	460	3	A95129.0 ³⁾	
29.00	1.1417	385	580	3		A95229.0 ⁴⁾
30.00	1.1811	305	460	3	A95130.0 ³⁾	
30.00	1.1811	385	580	3		A95230.0 ⁴⁾
31.00	1.2205	410	610	3		A95231.0 ⁴⁾
32.00	1.2598	410	635	4		A95232.0 ⁴⁾
33.00	1.2992	410	635	4		A95233.0 ⁴⁾
34.00	1.3386	430	665	4		A95234.0 ⁴⁾
35.00	1.3780	430	665	4		A95235.0 ⁴⁾
38.00	1.4961	460	695	4		A95238.0 ⁴⁾
40.00	1.5748	460	695	4		A95240.0 ⁴⁾

³⁾ < 15xD

⁴⁾ < 20xD

A402



A402

- 多刃阶梯钻 - 180°
- Broca Escalonada - 180°
- Broca Bidiametral - 180°
- Subland Drill - 180°

A402	▪	1.1	1.2	1.3	1.4	3.1	3.2															
	•	1.5	1.6	2.1	2.2	2.3	3.3	3.4	4.1	4.2	4.3	5.1	5.2	5.3	6.1	6.2	6.3	6.4	7.1	7.2	7.3	
		7.4	8.1																			



M	d ₁ Ø mm	d ₁ decimal Inch	l ₂ mm	l ₁ mm	l ₃ mm	d ₂ Ø mm	A402
M3	3.40	0.1339	57	93	9	6	A402M3
M4	4.50	0.1772	75	117	11	8	A402M4
M5	5.50	0.2165	87	133	13	10	A402M5
M6	6.60	0.2598	94	142	15	11	A402M6
M8	9.00	0.3543	114	169	19	15	A402M8
M10	11.00	0.4331	130	191	23	18	A402M10

A412



A412

- 阶梯钻
- Broca Escalonada
- Broca escalonada
- Step Drill

A412	▪	1.1	1.2	1.3	1.4	2.1	3.1	3.2														
	•	1.5	1.6	2.2	2.3	3.3	3.4	4.1	4.2	4.3	5.1	5.2	5.3	6.1	6.2	6.3	6.4	7.1	7.2	7.3	7.4	
		8.1																				



M	d ₁ ∅ mm	d ₁ decimal Inch	l ₂ mm	l ₁ mm	l ₃ mm	d ₂ ∅ mm	A412
M3	3.40	0.1339	31	70	9	6.6	A412M3
M4	4.50	0.1772	40	84	11	9	A412M4
M5	5.50	0.2165	47	95	13	11	A412M5
M6	6.60	0.2598	51	102	15	13	A412M6
M8	9.00	0.3543	62	123	19	17.2	A412M8
M10	11.00	0.4331	70	141	23	21.5	A412M10

A413



A413

- 阶梯钻
- Broca Escalonada
- Broca escalonada
- Step Drill

A413	▪	1.1	1.2	1.3	1.4	2.1	3.1	3.2														
	•	1.5	1.6	2.2	2.3	3.3	3.4	4.1	4.2	4.3	5.1	5.2	5.3	6.1	6.2	6.3	6.4	7.1	7.2	7.3	7.4	
		8.1																				



M	d ₁ Ø mm	d ₁ decimal Inch	l ₂ mm	l ₁ mm	l ₃ mm	d ₂ Ø mm	A413
M3	3.40	0.1339	28	66	9	6	A413M3
M4	4.50	0.1772	37	79	11	8	A413M4
M5	5.50	0.2165	43	89	13	10	A413M5
M6	6.60	0.2598	47	95	15	11	A413M6
M8	9.00	0.3543	56	111	19	15	A413M8
M10	11.00	0.4331	62	123	23	18	A413M10



- A200**
- 中心钻 - 60°
 - Broca de Centrar - 60°
- A205**
- Brocas de Centrar - 60°
 - Centre Drill - 60°

A200; A205	▪	1.1	1.2	1.3	1.4	3.1	3.2												
	•	1.5	1.6	2.1	2.2	2.3	3.3	3.4	4.1	4.2	4.3	5.1	5.2	5.3	6.1	6.2	6.3	6.4	7.1
		7.2	7.3	7.4	8.1	8.2	8.3	9.1											



d_1 Ø mm	d_1 decimal Inch	l_2 max/min mm	l_1 mm	d_2 Ø mm	A200	A205
0.50	0.0197	0.9 - 0.6	25	3.15	A200.5X3.15	
0.80	0.0315	1.3 - 1.0	25	3.15	A200.8X3.15	
1.00	0.0394	1.7 - 1.3	31	3.15	A2001.0X3.15	A2051.0X3.15
1.25	0.0492	2.0 - 1.6	31	3.15	A2001.25X3.15	A2051.25X3.15
1.60	0.0630	2.6 - 2.0	35	4.00	A2001.6X4.0	A2051.6X4.0
2.00	0.0787	3.1 - 2.5	40	5.00	A2002.0X5.0	A2052.0X5.0
2.50	0.0984	3.8 - 3.1	45	6.30	A2002.5X6.3	A2052.5X6.3
3.15	0.1240	4.6 - 3.9	50	8.00	A2003.15X8.0	A2053.15X8.0
4.00	0.1575	5.9 - 5.0	55	10.00	A2004.0X10.0	A2054.0X10.0
5.00	0.1969	7.2 - 6.3	63	12.50	A2005.0X12.5	A2055.0X12.5
6.30	0.2480	8.9 - 8.0	71	16.00	A2006.3X16.0	
8.00	0.3150	11.1 - 10.1	80	20.00	A2008.0X20.0	
10.00	0.3937	13.8 - 12.8	100	25.00	A20010.0X25.0	
12.50	0.4921	17.5 - 16.5	125	31.50	A20012.5X31.5	

⁵⁾ 只有单头的 / Única punta / Afilada sólo por una punta / Single Ended Only

A201



- 中心钻 - 60°
- Broca de Centrar - 60°
- Brocas de Centrar - 60°
- Centre Drill - 60°

A201

A201	▪	1.1	1.2	1.3	1.4	3.1	3.2														
	•	1.5	1.6	2.1	2.2	2.3	3.3	3.4	4.1	4.2	4.3	5.1	5.2	5.3	6.1	6.2	6.3	6.4	7.1	7.2	7.3
		7.4	8.1	8.2	8.3	9.1															



d_1 Ø mm	d_1 decimal Inch	l_2 max/min mm	l_1 mm	d_2 Ø mm	A201
0.63	0.0248	1.2 - 0.9	20	3.15	A201.63X3.15 ⁵⁾
0.75	0.0295	1.3 - 1.0	35	3.50	A201.75X3.5
1.00	0.0394	2.1 - 1.5	35	4.00	A2011.0X4.0
1.50	0.0591	2.8 - 2.0	40	5.00	A2011.5X5.0
1.60	0.0630	2.4 - 2.0	40	5.00	A2011.6X5.0
2.00	0.0787	4.0 - 3.0	45	6.00	A2012.0X6.0
2.00	0.0787	2.9 - 2.5	45	6.30	A2012.0X6.3
2.50	0.0984	4.5 - 3.5	50	8.00	A2012.5X8.0
3.00	0.1181	4.4 - 3.9	50	8.00	A2013.0X8.0
3.00	0.1181	5.0 - 4.0	56	10.00	A2013.0X10.0
3.15	0.1240	4.4 - 3.9	56	10.00	A2013.15X10.0
4.00	0.1575	6.2 - 5.0	66	12.00	A2014.0X12.0
5.00	0.1969	7.7 - 6.5	78	14.00	A2015.0X14.0
6.00	0.2362	9.2 - 8.0	90	18.00	A2016.0X18.0

⁵⁾ 只有单头的 / Única punta / Afilada sólo por una punta / Single Ended Only

A225

HSS

BS
328

1XD



A296

127

- 中心钻 - 60°
- Broca de Centrar - 60°
- Brocas de Centrar - 60°
- Centre Drill - 60°

A225

A225	▪	1.1	1.2	1.3	1.4	3.1	3.2														
	•	1.5	1.6	2.1	2.2	2.3	3.3	3.4	4.1	4.2	4.3	5.1	5.2	5.3	6.1	6.2	6.3	6.4	7.1	7.2	7.3
		7.4	8.1	8.2	8.3	9.1															



A225



3/64 - 5/16

Nr.	d ₁ Ø Inch	d ₁ decimal Inch	l ₂ max/min Inch	l ₁ Inch	d ₂ Ø Inch	A225
BS1	3/64	0.0469	5/64 - 1/16	1.1/2	1/8	A225BS1
BS2	1/16	0.0625	3/32 - 5/64	1.3/4	3/16	A225BS2
BS3	3/32	0.0938	5/32 - 1/8	2"	1/4	A225BS3
BS4	1/8	0.1250	3/16 - 5/32	2.1/4	5/16	A225BS4
BS5	3/16	0.1875	9/32 - 1/4	2.1/2	7/16	A225BS5
BS5A	7/32	0.2188	5/16 - 9/32	2.3/4	1/2	A225BS5A
BS6	1/4	0.2500	3/8 - 5/16	3"	5/8	A225BS6
BS7	5/16	0.3125	15/32 - 13/32	3.1/2	3/4	A225BS7

A088

- 套装短型钻头
- Jogo de Broca Série Curta
- Juego de Brocas, serie corta
- Stub Drill Set

A=套件中的型号, B=套件中的数量, C=套件中的直径

A=Tipos no jogo B=No. no Jogo C=Diâmetros no jogo

A=Tipos en el juego, B=No. en el Juego, C=Diámetros en el Juego

A=Styles in Set, B=No. in Set, C=Diameters in Set



Nr.	A	B	C	A088
200S	A022	24	1.0 mm - 10.5 mm x 0.5 mm + 3.3 mm, 4.2 mm, 6.8 mm, 10.2 mm	A088200S

A095

- 套装普通长度钻头
- Jogo de Brocas Série Normal
- Juego de Brocas, serie corta
- Jobber Drill Set

A=套件中的型号, B=套件中的数量, C=套件中的直径
 A=Tipos no jogo B=No. no Jogo C=Diâmetros no jogo
 A=Tipos en el juego, B=No. en el Juego, C=Diámetros en el Juego
 A=Styles in Set, B=No. in Set, C=Diameters in Set



Nr.	A	B	C	A095
18	A002	29	1/16 inch - 1/2 inch x 1/64 inch	A09518
20	A002	15	1/16 inch - 1/2 inch x 1/32 inch	A09520
200	A002	24	1.0 mm - 10.5 mm x 0.5 mm + 3.3 mm, 4.2 mm, 6.8 mm, 10.2 mm	A095200
201	A002	19	1.0 mm - 10.0 mm x 0.5 mm	A095201
202	A002	51	1.0 mm - 6.0 mm x 0.1 mm	A095202
203	A002	41	6.0 mm - 10.0 mm x 0.1 mm	A095203
204	A002	25	1.0 mm - 13.0 mm x 0.5 mm	A095204
206	A002	29	1.0 mm - 13.0 mm x 0.5 mm + 3.3 mm, 4.2 mm, 6.8 mm, 10.2 mm	A095206
209	A002	91	1.0 mm - 10.0 mm x 0.1 mm	A095209

A099

- 成套展示钻头 A=套件中的型号, B=套件中的数量, C=套件中的直径
- Display de Brocas A=Tipos no jogo B=No. no Jogo C=Diâmetros no jogo
- Exhibidor de Brocas A=Tipos en el juego, B=No. en el Juego, C=Diámetros en el Juego
- Counter Dispenser A=Styles in Set, B=No. in Set, C=Diameters in Set



				A099
Nr.	A	B	C	
F1	A002	380	5 x (13/32, 7/16, 15/32, 1/2) inch; 10 x (5/64, 7/64, 9/64, 11/64, 13/64, 15/64, 17/64, 9/32, 19/64, 5/16, 21/64, 11/32, 23/64, 3/8) inch; 20 x (1/16, 7/32, 1/4) inch; 30 x 3/32 inch; 40 x (5/32, 3/16) inch; 50 x 1/8 inch	A099F1
M1	A002	340	5 x (10.50, 11.00, 11.50, 12.00, 12.50, 13.00) mm; 10 x (1.50, 2.50, 3.50, 4.50, 5.50, 6.50, 7.00, 7.50, 8.00, 8.50, 9.00, 9.50, 10.00) mm; 20 x (1.00, 5.00, 6.00) mm; 30 x 2.00 mm; 40 x 4.00 mm; 50 x 3.00 mm	A099M1

A190

- 套装普通长度钻头
- Jogo de Brocas Série Normal
- Juego de Brocas, serie corta
- Jobber Drill Set

A=套件中的型号, B=套件中的数量, C=套件中的直径
 A=Tipos no jogo B=No. no Jogo C=Diâmetros no jogo
 A=Tipos en el juego, B=No. en el Juego, C=Diámetros en el Juego
 A=Styles in Set, B=No. in Set, C=Diameters in Set



Nr.	A	B	C	A190
3	A100	21	1/16 inch - 3/8 inch x 1/64 inch	A1903
12	A100	60	No.1 - No.60	A19012
14	A100	26	A - Z	A19014
18	A100	29	1/16 inch - 1/2 inch x 1/64 inch	A19018
20	A100	15	1/16 inch - 1/2 inch x 1/32 inch	A19020
201	A100	19	1.0 mm - 10.0 mm x 0.5 mm	A190201
202	A100	51	1.0 mm - 6.0 mm x 0.1 mm	A190202
203	A100	41	6.0 mm - 10.0 mm x 0.1 mm	A190203
204	A100	25	1.0 mm - 13.0 mm x 0.5 mm	A190204
206	A100	29	1.0 mm - 13.0 mm x 0.5 mm + 3.3 mm, 4.2 mm, 6.8 mm, 10.2 mm	A190206
209	A100	91	1.0 mm - 10.0 mm x 0.1 mm	A190209

A094

- 套装普通长度钻头
- Jogo de Brocas Série Normal
- Juego de Brocas, serie corta
- Jobber Drill Set

A=套件中的型号, B=套件中的数量, C=套件中的直径

A=Tipos no jogo B=No. no Jogo C=Diâmetros no jogo

A=Tipos en el juego, B=No. en el Juego, C=Diámetros en el Juego

A=Styles in Set, B=No. in Set, C=Diameters in Set



Nr.	A	B	C	A094
413	A002	13	1.5 mm - 6.5 mm x 0.5 mm + 3.3 mm, 4.2 mm	A094413
419	A002	19	1.0 mm - 10.0 mm x 0.5 mm	A094419

A191

- 套装普通长度钻头 A=套件中的型号, B=套件中的数量, C=套件中的直径
- Jogo de Brocas Série Normal A=Tipos no jogo B=No. no Jogo C=Diâmetros no jogo
- Juego de Brocas, serie corta A=Tipos en el juego, B=No. en el Juego, C=Diámetros en el Juego
- Jobber Drill Set A=Styles in Set, B=No. in Set, C=Diameters in Set



Nr.	A	B	C	A191
31M	A100	20	0.3 mm - 1.0 mm x 0.05 mm + 0.38 mm, 0.52 mm, 0.58 mm, 0.78 mm, 0.82 mm	A19131M
61-80	A100	20	No.61 - No. 80	A19161-80
413	A100	13	1.5 mm - 6.5 mm x 0.5 mm + 3.3 mm, 4.2 mm	A191413
419	A100	19	1.0 mm - 10.0 mm x 0.5 mm	A191419

A199

- 成套展示钻头
- Display de Brocas
- Exhibidor de Brocas
- Counter Dispenser

A=套件中的型号, B=套件中的数量, C=套件中的直径
 A=Tipos no jogo B=No. no Jogo C=Diâmetros no jogo
 A=Tipos en el juego, B=No. en el Juego, C=Diámetros en el Juego
 A=Styles in Set, B=No. in Set, C=Diameters in Set



Nr.	A	B	C	
F1	A100	380	5 x (13/32, 7/16, 15/32, 1/2) inch; 10 x (5/64, 7/64, 9/64, 11/64, 13/64, 15/64, 17/64, 9/32, 19/64, 5/16, 21/64, 11/32, 23/64, 3/8) inch; 20 x (1/16, 7/32, 1/4) inch; 30 x 3/32 inch; 40 x (5/32, 3/16) inch; 50 x 1/8 inch	A199F1
M1	A100	340	5 x (10.50, 11.00, 11.50, 12.00, 12.50, 13.00) mm; 10 x (1.50, 2.50, 3.50, 4.50, 5.50, 6.50, 7.00, 7.50, 8.00, 8.50, 9.00, 9.50, 10.00) mm; 20 x (1.00, 5.00, 6.00) mm; 30 x 2.00 mm; 40 x 4.00 mm; 50 x 3.00mm	A199M1

A295

- 套装普通长度钻头
- Jogo de Brocas Série Normal
- Juego de Brocas, serie corta
- Jobber Drill Set

A=套件中的型号, B=套件中的数量, C=套件中的直径
 A=Tipos no jogo B=No. no Jogo C=Diâmetros no jogo
 A=Tipos en el juego, B=No. en el Juego, C=Diámetros en el Juego
 A=Styles in Set, B=No. in Set, C=Diameters in Set



Nr.	A	B	C	A295
219	A777	19	1.0 mm - 10.0 mm x 0.5 mm	A295219
225	A777	25	1.0 mm - 13.0 mm x 0.5 mm	A295225

A296

- 中心钻套装
- Jogo de Brocas de Centrar
- Juego de Brocas de Centrar
- Centre Drill Set

A296200 - 118° 顶角, DIN333A; A296225 - 120° 顶角, BS328
 A=套件中的型号, B=套件中的数量, C=套件中的直径
 A296200 - ponta 118° DIN333A, A296225 - ponta 120° BS328
 A=Tipos no jogo B=No. no Jogo C=Diâmetros no jogo
 A296200 - 118° DIN333A, A296225 - 120° BS328
 A=Tipos en el juego, B=No. en el Juego, C=Diámetros en el Juego
 A296200 - 118° point DIN333A, A296225 - 120° point BS328
 A=Styles in Set B=No. in Set, C=Diameters in Set



Nr.	A	B	C	A296
200	A200	5	1.00 mm, 2.00 mm, 2.50 mm, 3.15 mm, 4.00 mm	A296200
225	A225	5	BS1, BS2, BS3, BS4, BS5	A296225

B400 138
B411 142
B441 141

B442 143
B481 139

G400 169
G405 170



129 - 186



B100 144
B101 162
B121 164
B122 152
B157 159
B161 160
B170 156

B180 154
B301 149
B334 146
B335 147
B901 148
B903 150
B952 151

B953 153
B954 165
B955 166
B956 167
B957 168

G125 184
G129 174
G132 179
G135 171
G136 176
G137 172
G138 180
G142 176
G149 175
G154 173
G171 181
G236 185
G314 183
G335 171
G338 180
G560 176
G570 176
G600 178
M138 182

材料	Material	Material	Material
涂层	Tratamento	Tratamiento superficial	Coating
标准	Norma	Estándar	Standard
加工方向	Direção	Dirección	Direction
柄部	Haste	Mango	Shank
槽型	Tipo de Canal	Tipo de Canal	Flute Style
公差	Tolerância	Tolerancia	Tolerance
锥度	Escala de conicidade	Escala de conicidad	Taper gradient
<ul style="list-style-type: none"> ■ 性能卓越 ■ 性能良好 实例 10 = 外缘处的切削速度，米/分， +/- 10%	Excelente para a Aplicação Bom para a Aplicação Exemplo 10 = Velocidade periférica em metros/minuto +/- 10%	Excelente para Aplicación Bueno para Aplicación Ejemplo 10 = Velocidad Periférica en metros/minuto +/- 10%	Excellent for Application Good for Application Example 10 = Peripheral speed in metres/minute +/- 10%
产品型号	Código	Código de producto	Product Codes
尺寸范围	Gama de medidas	Rango de Diámetros	Size Range

AMG	中文	Português	Español	English
1.1	铁磁性低碳钢	Aço macio magnético	Acero blando	Magnetic soft steel
1.2	结构钢，表面渗碳钢	Aço estrutural, Aço cementado	Acero de construcción/cementación	Structural steel, case carburizing steel
1.3	普通碳钢	Aço-carbono	Acero al carbono	Plain Carbon steel
1.4	合金钢	Aço de liga	Acero aleado	Alloy steel
1.5	合金钢，淬火回火钢	Aço de liga, Aço temperado	Acero aleado/temple y revenido	Alloy steel, Hardened and tempered steel
1.6	合金钢，淬火回火钢	Aço de liga, Aço temperado	Acero aleado/temple y revenido	Alloy steel, Hardened and tempered steel
1.7	热处理合金钢	Aço de liga temperado	Acero aleado cementado	Alloy steel, Heat treated
1.8	淬火合金钢，耐磨钢	Aço de liga temperado	Acero aleado cementado	Alloy steel, Hardened & Wear resistant steel
2.1	易切削不锈钢	Aço inoxidável de maquinagem fácil	Acero inoxidable fácil mecanizado	Free machining, Stainless Steel
2.2	奥氏体不锈钢	Austenítico	Austenítico	Austenitic
2.3	铁素体 + 奥氏体，马氏体不锈钢	Ferrítico + Austenítico + Martensítico	Ferrítico, Ferr. + Aust., Marten	Ferritic + Austenitic, Ferritic, Martensitic
2.4	沉淀硬化不锈钢	Aço inoxidável de fácil usinagem	Acero Inoxidable Templado	Precipitation Hardened
3.1	灰铸铁	Grafite laminar	Con grafito laminar	Lamellar graphite
3.2	灰铸铁	Grafite laminar	Con grafito laminar	Lamellar graphite
3.3	球墨铸铁，可锻铸铁	Grafite nodular/ Ferro fundido maleável	Con graf. laminar, fundic. maleable	Nodular graphite, Malleable Cast Iron
3.4	球墨铸铁，可锻铸铁	Grafite nodular/ Ferro fundido maleável	Con graf. laminar, fundic. maleable	Nodular graphite, Malleable Cast Iron
4.1	纯钛	Titânio, sem liga	Titanio no aleado	Titanium, unalloyed
4.2	钛合金	Titânio, com liga	Titanio aleado	Titanium, alloyed
4.3	钛合金	Titânio, com liga	Titanio aleado	Titanium, alloyed
5.1	纯镍	Níquel, sem liga	Níquel no aleado	Nickel, unalloyed
5.2	镍合金	Níquel, com liga	Níquel aleado	Nickel, alloyed
5.3	镍合金	Níquel, com liga	Níquel aleado	Nickel, alloyed
6.1	紫铜	Cobre	Cobre	Copper
6.2	β黄铜，青铜	Latão beta, bronze	β-Latón, bronce	β-Brass, Bronze
6.3	α黄铜	Latão alfa	α-Latón	α-Brass
6.4	高强度青铜	Bronze de alta resistência	Metal AMPCO	High Strength Bronze
7.1	纯铝，纯镁	Al, Mg, sem liga	Al, Mg, no aleado	Al, Mg, unalloyed
7.2	铝合金，硅含量 < 0.5%	Al com liga, Si<0.5%	Al aleado con Si < 0.5%	Al alloyed, Si < 0.5%
7.3	铝合金，硅含量 > 0.5% < 10%	Al com liga, Si>0.5%<10%	Al aleado con Si > 0.5% < 10%	Al alloyed, Si > 0.5% < 10%
7.4	铝合金，硅含量 > 10% 晶须增强铝合金，镁合金	Al com liga, Si>10% reforçadas com monocristais filiformes, ligas de Al/Mg	Al aleado, Si>10% Reforzado por filamentos, Al-aleados, Mg-aleados	Al alloyed, Si > 10% Whisker reinforced Al-alloys Mg-alloys
8.1	热塑性塑料	Termoplásticos	Termoplásticos	Thermoplastics
8.2	热固性塑料	Plásticos termoduros	Plásticos endurecidos por calor	Thermosetting plastics
8.3	增强塑料	Materiais plásticos reforçados	Materiales plásticos reforzados	Reinforced plastic materials
9.1	金属陶瓷	Cerametal (metalocerâmica)	Cerametales (metales-cerâmicas)	Cermets (metals-ceramics)
10.1	标准石墨	Grafite standard	Grafito standard	Graphite

	HM	HM	HM	HM	HM	HSS	HSS	HSS	HSS-E	HSS	HSS	HSS	HSS	
	DIN 8093	DIN 8093	DIN 8050	DIN 8094	DIN 8051	DIN 206	DORMER	DORMER	BS 328	BS 328	DIN 9	DIN 9	ANSI	
	H7	Ø 95.3-5 S: +0.004 Ø 5.51-12 D: +0.005	H7	H7	H7	H7			H7					
										1.48 ▶	1.50 ▶	1.50 ▶		
	B400	B481	B441	B411	B442	B100	B334	B335	B901	B301	B903	B952	B122	
	1.00 - 20.00	0.98 - 12.05	10.00 - 20.00	5.00 - 30.00	10.00 - 20.00	1.50 - 50.00	N000 - N16	N000 BLADES - N16NUT	1.50 - 1/2	1/16 - 1/2	1.50 - 20.00	1.20 - 50.00	3/8 - 1.1/16	
AMG	138	138	141	142	143	144	146	147	148	149	150	151	152	ISO
1.1	■18B	■18B	■18B	■18B	■18B	■18C	■		■18C	■18C	■18C	■18C	■18C	P 1
1.2	■18B	■18B	■18B	■18B	■18B	■14C	■		■14C	■14C	■14C	■14C	■14C	P 1
1.3	■14B	■14B	■14B	■14B	■14B	■11C	■		■11C	■11C	■11C	■11C	■11C	P 2
1.4	■14B	■14B	■14B	■14B	■14B	■10B	■		■10B	■10B	■10B	■10B	■10B	P 3
1.5	■10C	■10C	■10C	■10C	■10C	■5B	■		■5B	■5B	■5B	■5B	■5B	P 4
1.6	■10C	■10C	■10C	■10C	■10C	■4A	■		■4A	■4A	■4A	■4A	■4A	H 1
1.7														H 3
1.8														H 4
2.1						■8F	■		■8C	■8C	■8C	■8C	■8C	M 1
2.2										■5B	■5B	■5B	■5B	M 3
2.3										■6B	■6B	■6B	■6B	M 2
2.4														S 2
3.1	■17D	■17D	■17D	■17D	■17D	■14E	■		■14E	■14E	■14E	■14E	■14E	K 1
3.2	■17D	■17D	■17D	■17D	■17D	■11D	■		■11D	■11D	■11D	■11D	■11D	K 2
3.3	■17D	■17D	■17D	■17D	■17D	■10C	■		■10C	■10C	■10C	■10C	■10C	K 3
3.4	■14D	■14D	■14D	■14D	■14D	■9C	■		■9C	■9C	■9C	■9C	■9C	K 4
4.1	■14C	■14C	■14C	■14C	■14C	■11C	■		■11C	■11C	■11C	■11C	■11C	S 1
4.2	■14C	■14C	■14C	■14C	■14C	■5B	■		■5B	■5B	■5B	■5B	■5B	S 2
4.3	■10B	■10B	■10B	■10B	■10B	■4B	■		■4B	■4B	■4B	■4B	■4B	S 3
5.1	■10C	■10C	■10C	■10C	■10C	■5D	■		■5D	■5D	■5D	■5D	■5D	S 1
5.2	■10B	■10B	■10B	■10B	■10B	■3C	■		■3C					S 2
5.3	■10B	■10B	■10B	■10B	■10B	■2C	■		■2C					S 3
6.1	■38E	■38E	■38E	■38E	■38E	■18D	■		■18D	■18D	■18D	■18D	■18D	N 3
6.2	■38E	■38E	■38E	■38E	■38E	■20E	■		■20E	■20E	■20E	■20E	■20E	N 4
6.3	■38E	■38E	■38E	■38E	■38E	■18D	■		■18D	■18D	■18D	■18D	■18D	N 3
6.4	■38D	■38D	■38D	■38D	■38D	■11D	■		■11D	■11D	■11D	■11D	■11D	N 4
7.1	■60D	■60D	■60D	■60D	■60D	■23F	■		■23F	■23F	■23F	■23F	■23F	N 1
7.2	■60D	■60D	■60D	■60D	■60D	■18F	■		■18F	■18F	■18F	■18F	■18F	N 1
7.3	■25D	■25D	■25D	■25D	■25D				■15E	■15E	■15E	■15E	■15E	N 1
7.4	■25D	■25D	■25D	■25D	■25D				■14D	■14D	■14D	■14D	■14D	N 2
8.1	■25C	■25C	■25C	■25C	■25C									O
8.2	■13C	■13C	■13C	■13C	■13C	■21B	■		■21B	■21B	■21B	■21B	■21B	O
8.3														O
9.1														H
10.1														O

HSS-E	HSS-E	HSS-E	HSS-E	HSS-E	HSS-E	HSS-E	HSS	HSS-E	HSS-E	HSS-E
DIN 2179	DIN 212	DIN 212	DIN 212	DIN 208	BS 328	DIN 311	DIN 2180	DIN 219	DIN 217	
	DIN 6939FA									
	B	B	E	B	B			B		
	H7	$\begin{matrix} \varnothing 66 \pm 0.5 \\ \varnothing 45 \pm 0.04 \\ \varnothing 45.51 \pm 2 \\ \varnothing 40.006 \end{matrix}$	H7	H7	H7		k11	H7		
1:50 ▶								1:50 ▶		
B953	B180	B170	B157	B161	B101	B121	B954	B955	B956	B957
1.00 - 12.00	1.50 - 20.00	0.98 - 12.00	2.00 - 20.00	3.00 - 50.00	3.00 - 2"	10.00 - 30.00	5.00 - 30.00	25.00 - 80.00	13.00 - 40.00	N3DRIVER - N9WASHER

AMG	153	154	156	159	160	162	164	165	166	167	168	ISO
1.1	■25C	■25C	■25C	■25C	■25C	■18C	■18C	■25C	■18C			P 1
1.2	■20C	■20C	■20C	■20C	■20C	■14C	■14C	■20C	■14C			P 1
1.3	■16C	■16C	■16C	■16C	■16C	■11C	■11C	■16C	■11C			P 2
1.4	■15B	■15B	■15B	■15B	■15B	■10B	■10B	■15B	■10B			P 3
1.5	■9B	■9B	■9B	■9B	■9B	■5B	■5B	■9B	■5B			P 4
1.6	■5A	■5A	■5A	■5A	■5A	■4A	■4A	■5A	■4A			H 1
1.7												H 3
1.8												H 4
2.1	■11C	■11C	■11C	■11C	■11C	■8C		■11C	■8C			M 1
2.2	■6B	■6B	■6B	■6B	■6B			■6B	■5B			M 3
2.3	■8B	■8B	■8B	■8B	■8B			■8B	■6B			M 2
2.4		■6B										S 2
3.1		■16E	■16E		■16E	■14E	■14E		■14E			K 1
3.2		■15D	■15D		■15D	■11D	■11D					K 2
3.3		■13C	■13C		■13C	■10C	■10C					K 3
3.4		■11C	■11C		■11C	■9C	■9C					K 4
4.1	■15C	■15C	■15C	■15C	■15C	■11C	■11C	■15C	■11C			S 1
4.2	■9B	■9B	■9B	■9B	■9B	■5B		■9B	■5B			S 2
4.3	■5B	■5B	■5B	■5B	■5B	■4B		■5B	■4B			S 3
5.1	■8D	■8D	■8D	■8D	■8D	■5D		■8D	■5D			S 1
5.2	■5C	■5C	■5C	■5C	■5C	■3C		■5C	■3C			S 2
5.3	■3C	■3C	■3C	■3C	■3C	■2C		■3C	■2C			S 3
6.1	■25D	■25D	■25D	■25D	■25D	■18D		■25D	■18D			N 3
6.2	■28E	■28E	■28E	■28E	■28E	■20E		■28E	■20E			N 4
6.3		■25D	■25D		■25D	■18D						N 3
6.4		■14D	■14D		■14D	■11D						N 4
7.1	■28F			■28F		■23F		■28F	■23F			N 1
7.2	■25F			■25F		■18F		■25F	■18F			N 1
7.3	■20E			■20E				■20E	■15E			N 1
7.4	■16D			■16D				■16D	■14D			N 2
8.1	■30B			■30B				■30B				O
8.2						■21B	■21B		■21B			O
8.3												O
9.1	■3A			■3A				■3A				H
10.1												O

材料	Material	Material	Material
涂层	Tratamento	Tratamiento superficial	Coating
标准	Norma	Estándar	Standard
加工方向	Direção	Dirección	Direction
应用	Aplicação	Aplicaciones	Application
柄部	Haste	Mango	Shank
镗孔度数	Ângulo de Escareado	° de avellanado	Countersink °
■ 性能卓越	Excelente para a Aplicação	Excelente para Aplicación	Excellent for Application
■ 性能良好	Bom para a Aplicação	Bueno para Aplicación	Good for Application
实例 10 = 外缘处的切削速度，米/分， +/- 10%	Exemplo 10 = Velocidade periférica em metros/minuto +/- 10%	Ejemplo 10 = Velocidad Periférica en metros/minuto +/- 10%	Example 10 = Peripheral speed in metres/minute +/- 10%
产品型号	Código	Código de producto	Product Codes
尺寸范围	Gama de medidas	Rango de Diámetros	Size Range

AMG	中文	Português	Español	English
1.1	铁磁性低碳钢	Aço macio magnético	Acero blando	Magnetic soft steel
1.2	结构钢, 表面渗碳钢	Aço estrutural, Aço cementado	Acero de construcción/cementación	Structural steel, case carburizing steel
1.3	普通碳钢	Aço-carbono	Acero al carbono	Plain Carbon steel
1.4	合金钢	Aço de liga	Acero aleado	Alloy steel
1.5	合金钢, 淬火回火钢	Aço de liga, Aço temperado	Acero aleado/temple y revenido	Alloy steel, Hardened and tempered steel
1.6	合金钢, 淬火回火钢	Aço de liga, Aço temperado	Acero aleado/temple y revenido	Alloy steel, Hardened and tempered steel
1.7	热处理合金钢	Aço de liga temperado	Acero aleado cementado	Alloy steel, Heat treated
1.8	淬火合金钢, 耐磨钢	Aço de liga temperado	Acero aleado cementado	Alloy steel, Hardened & Wear resistant steel
2.1	易切削不锈钢	Aço inoxidável de maquinação fácil	Acero inoxidable fácil mecanizado	Free machining, Stainless Steel
2.2	奥氏体不锈钢	Austenítico	Austenítico	Austenitic
2.3	铁素体 + 奥氏体, 马氏体不锈钢	Ferrítico + Austenítico + Martensítico	Ferrítico, Ferr. + Aust., Marten	Ferritic + Austenitic, Ferritic, Martensitic
2.4	沉淀硬化不锈钢	Aço inoxidável de fácil usinagem	Acero Inoxidable Templado	Precipitation Hardened
3.1	灰铸铁	Grafite laminar	Con grafito laminar	Lamellar graphite
3.2	灰铸铁	Grafite laminar	Con grafito laminar	Lamellar graphite
3.3	球墨铸铁, 可锻铸铁	Grafite nodular/ Ferro fundido maleável	Con graf. laminar, fundic. maleable	Nodular graphite, Malleable Cast Iron
3.4	球墨铸铁, 可锻铸铁	Grafite nodular/ Ferro fundido maleável	Con graf. laminar, fundic. maleable	Nodular graphite, Malleable Cast Iron
4.1	纯钛	Titânio, sem liga	Titanio no aleado	Titanium, unalloyed
4.2	钛合金	Titânio, com liga	Titanio aleado	Titanium, alloyed
4.3	钛合金	Titânio, com liga	Titanio aleado	Titanium, alloyed
5.1	纯镍	Níquel, sem liga	Níquel no aleado	Nickel, unalloyed
5.2	镍合金	Níquel, com liga	Níquel aleado	Nickel, alloyed
5.3	镍合金	Níquel, com liga	Níquel aleado	Nickel, alloyed
6.1	紫铜	Cobre	Cobre	Copper
6.2	β黄铜, 青铜	Latão beta, bronze	β-Latón, bronce	β-Brass, Bronze
6.3	α黄铜	Latão alfa	α-Latón	α-Brass
6.4	高强度青铜	Bronze de alta resistência	Metal AMPCO	High Strength Bronze
7.1	纯铝, 纯镁	Al, Mg, sem liga	Al, Mg, no aleado	Al, Mg, unalloyed
7.2	铝合金, 硅含量 < 0.5%	Al com liga, Si<0.5%	Al aleado con Si < 0.5%	Al alloyed, Si < 0.5%
7.3	铝合金, 硅含量 > 0.5% < 10%	Al com liga, Si>0.5%<10%	Al aleado con Si > 0.5% < 10%	Al alloyed, Si > 0.5% < 10%
7.4	铝合金, 硅含量 > 10% 晶须增强铝合金, 镁合金	Al com liga, Si>10% reforçadas com monocristais filiformes, ligas de Al/Mg	Al aleado, Si>10% Reforzado por filamentos, Al-aleados, Mg-aleados	Al alloyed, Si > 10% Whisker reinforced Al-alloys Mg-alloys
8.1	热塑性塑料	Termoplásticos	Termoplásticos	Thermoplastics
8.2	热固性塑料	Plásticos termoduros	Plásticos endurecidos por calor	Thermosetting plastics
8.3	增强塑料	Materiais plásticos reforçados	Materiales plásticos reforzados	Reinforced plastic materials
9.1	金属陶瓷	Cerametal (metalocerâmica)	Cermetales (metales-cerámicas)	Cermets (metals-ceramics)
10.1	标准石墨	Grafite standard	Grafito standard	Graphite

	HM	HM	HSS	HSS	HSS	HSS	HSS	HSS-E	HSS	HSS	HSS	
	DIN 335C	DIN 335	DIN 334C	DIN 334C	DIN 334D	DIN 335C	DORMER	DORMER	DIN 335C	DIN 335C	DIN 335C	
	G400	G405	G135	G335	G137	G154	G129	G149	G136	G560	G142	
	6.30 - 31.00	8.30 - 12.40	6.30 - 25.00	6.30 - 25.00	16.00 - 80.00	6.30 - 25.00	6.00 - 31.50	5.00 - 50.00	4.30 - 31.00	6.30 - 31.00	4.80 - 31.00	
AMG	169	170	171	171	172	173	174	175	176	176	176	ISO
1.1	30F	30F	30F	50E	30F	30F	30D	30D	30F	50E	30F	P 1
1.2	25E	25E	25E	40E	25E	25E	25D	25D	25E	40E	25E	P 1
1.3	20D	20D	20D	30D	20D	20D	20C	20C	20D	30D	20D	P 2
1.4	15D	15D	15D	20D	15D	15D	15B	15B	15D	20D	15D	P 3
1.5	10B	10B	10B	15B	10B	10B	10A	10A	10B	15B	10B	P 4
1.6	6A	6A	6A	10B	6A	6A	6A	6A	6A	10B	6A	H 1
1.7												H 3
1.8												H 4
2.1	8C	8C	8C		8C	8C	8B	8B	8C		8C	M 1
2.2	6B	6B	6B		6B	6B	6A	6A	6B		6B	M 3
2.3	4A	4A	4A		4A	4A			4A		4A	M 2
2.4												S 2
3.1	25F	25F	25F	45F	25F	25F	25D	25D	25F	45F		K 1
3.2	15D	15D	15D	35D	15D	15D	15C	15C	15D	35D		K 2
3.3	12C	12C	12C	30C	12C	12C	12A	12A	12C	30C		K 3
3.4	8C	8C	8C	30C	8C	8C	8A	8A	8C	30C		K 4
4.1	12C	12C	12C	20C	12C	12C	12B	12B	12C	20C	12C	S 1
4.2	10A	10A	10A	15A	10A	10A	10A	10A	10A	15A	10A	S 2
4.3	8A	8A	8A	10A	8A	8A	8A	8A	8A	10A		S 3
5.1	12C	12C	12C	20C	12C	12C	12B	12B	12C	20C	12C	S 1
5.2	6B	6B	6B	10B	6B	6B	6A	6A	6B	10B	6B	S 2
5.3	4A	4A	4A	6A	4A	4A	4A	4A	4A	6A		S 3
6.1	25D	25D	25D	40D	25D	25D	25B	25B	25D	40D	25D	N 3
6.2	20F	20F	20F	30F	20F	20F	20C	20C	20F	30F	20F	N 4
6.3	25F	25F	25F	40F	25F	25F	25C	25C	25F	40F	25F	N 3
6.4	10D	10D	10D	15D	10D	10D	10B	10B	10D	15D	10D	N 4
7.1	30G	30G	30G	50G	30G	30G	30D	30D	30G	50G	30G	N 1
7.2	25F	25F	25F	40F	25F	25F	25C	25C	25F	40F	25F	N 1
7.3	20F	20F	20F	30F	20F	20F	20C	20C	20F	30F	20F	N 1
7.4	10F	10F	10F	15F	10F	10F	10C	10C	10F	15F	10F	N 2
8.1	30G	30G	30G	50G	30G	30G	30D	30D	30G	50G	30G	O
8.2	20G	20G	20G	30G	20G	20G	20D	20D	20G	30G	20G	O
8.3												O
9.1												H
10.1												O

	HSS-E	HSS	HSS	HSS	HSS	HSS	HSS	HSS	HSS		
	ATCH				TN	TAIN	ST				
	DIN 335C	DORMER	DIN 335A	DIN 335D	DIN 335D	DIN 335C	DORMER	DORMER	DIN 373		
	90°	90°	90°	90°	90°	100°	20°	20°	180°		
	G570	G600	G132	G138	G338	G171	M138	G314	G125	G236	
	6.30 - 31.00	6.30 - 25.00	8.00 - 20.00	25.00 - 80.00	25.00 - 63.00	6.30 - 25.00	No.1 - No.6	4.00 - 36.00	6.50 - 20.00	Set	
	NEW	NEW									
AMG	176	178	179	180	180	181	182	183	184	185	ISO
1.1	45E	22F		30F	50F	50E	30D	30D	30E		P 1
1.2	36E	17E		25E	40E	40E	25D	25D	25E		P 1
1.3	27D	15D	20E	20D	30D	30D	20C	20C	20D		P 2
1.4	22D	12D	15D	15D	20D	20D	15B	15B	15D		P 3
1.5	17B	8B	10D	10B	15B	15B	10A	10A	10C		P 4
1.6	12B	6A	6B	6A	10A	10B	6A	6A	6C		H 1
1.7											H 3
1.8											H 4
2.1	17C	8C		8C			8B	8B	8D		M 1
2.2	12B	6B		6B			6A	6A	6C		M 3
2.3	15A	4A	4B	4A			4A	4A			M 2
2.4	10A										S 2
3.1	40C	25F		25F	45F	45F	25D	25D	25E		K 1
3.2	32C	15D		15D	35D	35D	15C	15C	15E		K 2
3.3	27C	12C		12C	30C	30C	12A	12A	12D		K 3
3.4	24C		8D	8C	30C	30C	8A	8A	8C		K 4
4.1				12C	20C	20C	12B	12B	12E		S 1
4.2			8A	10A	15A	15A	10A	10A	10E		S 2
4.3			8A	8A	10A	10A	8A	8A	8E		S 3
5.1				12C	20C	20C	12B	12B	12E		S 1
5.2	6A		6C	6B	10B	10B	6A	6A	6C		S 2
5.3	4A		4B	4A	6A	6A	4A	4A	4E		S 3
6.1	40D	25D		25D	40D	40D	25B	25B	25C		N 3
6.2	30F	20F		20F	30F	30F	20C	20C	20C		N 4
6.3	40F	25F		25F	40F	40F	25C	25C	25C		N 3
6.4	15D	10D	10F	10D	15D	15D	10B	10B			N 4
7.1	45G	30G		30G	50G	50G	30D	30D	30G		N 1
7.2	36F	25F		25F	40F	40F	25C	25C	25G		N 1
7.3	27F	20F		20F	30F	30F	20C	20C	20G		N 1
7.4	13F	10F		10F	15F	15F	10C	10C	10E		N 2
8.1				30G	50G	50G	30D	30D	30C		O
8.2				20G	30G	30G	20D	20D	20C		O
8.3		5G									O
9.1											H
10.1											O

	Ø mm												
	1,5	2	3	5	8	10	12	16	20	25	30	40	50
A	0,045	0,055	0,078	0,100	0,150	0,170	0,185	0,220	0,250	0,280	0,320	0,390	0,440
B	0,055	0,072	0,110	0,150	0,180	0,210	0,240	0,280	0,310	0,360	0,400	0,500	0,550
C	0,065	0,085	0,135	0,185	0,220	0,260	0,285	0,335	0,390	0,440	0,480	0,600	0,680
D	0,080	0,110	0,160	0,200	0,270	0,320	0,360	0,410	0,470	0,540	0,600	0,730	0,850
E	0,100	0,140	0,180	0,250	0,350	0,390	0,430	0,500	0,530	0,640	0,750	0,910	1,100
F	0,140	0,180	0,260	0,350	0,440	0,500	0,550	0,630	0,700	0,800	0,930	1,200	1,500
mm/REV ± 15%													

	Ø mm									
	6	8	10	16	20	25	32	40	60	80
A	0.03	0.04	0.05	0.06	0.08	0.09	0.10	0.12	0.14	0.16
B	0.04	0.05	0.06	0.08	0.10	0.12	0.14	0.16	0.18	0.20
C	0.05	0.06	0.08	0.10	0.12	0.14	0.16	0.18	0.20	0.22
D	0.06	0.08	0.10	0.12	0.15	0.18	0.20	0.22	0.25	0.28
E	0.08	0.10	0.12	0.15	0.18	0.20	0.25	0.27	0.30	0.32
F	0.09	0.11	0.13	0.16	0.19	0.21	0.26	0.29	0.33	0.36
G	0.10	0.12	0.15	0.18	0.20	0.22	0.28	0.32	0.36	0.40
H	0.12	0.15	0.18	0.20	0.22	0.25	0.30	0.35	0.40	0.45
mm/REV										

• 预钻孔时确定铰削余量的一般准则 • Regras gerais para material a ser removido durante a furação • Guía general para la eliminación de material cuando existe agujero pre-taladrado • General guidelines for stock removal when pre-drilling holes

	Ø (mm)					
	3 - 5mm	5.1 - 10mm	10.1 - 20mm	20.1 - 30mm	> 30mm	
1.1	0.1-0.2	0.2	0.2-0.3	0.3-0.4	0.4-0.5	P 1
1.2	0.1-0.2	0.2	0.2-0.3	0.3-0.4	0.4-0.5	P 1
1.3	0.1-0.2	0.2	0.2-0.3	0.3-0.4	0.4-0.5	P 2
1.4	0.1-0.2	0.2	0.2	0.3	0.3-0.4	P 3
1.5	0.1-0.2	0.2	0.2	0.3	0.3-0.4	P 4
1.6	0.1-0.2	0.2	0.2	0.3	0.3-0.4	H 1
1.7	0.1-0.2	0.2	0.2	0.3	0.3-0.4	H 3
1.8	0.1-0.2	0.2	0.2	0.3	0.3-0.4	H 4
2.1	0.1-0.2	0.2	0.2	0.3	0.3-0.4	M 1
2.2	0.1-0.2	0.2	0.2	0.3	0.3-0.4	M 3
2.3	0.1-0.2	0.2	0.2	0.3	0.3-0.4	M 2
2.4	0.1-0.2	0.2	0.2	0.3	0.3-0.4	S 2
3.1	0.1-0.2	0.2	0.2-0.3	0.3-0.4	0.4-0.5	K 1
3.2	0.1-0.2	0.2	0.2-0.3	0.3-0.4	0.4-0.5	K 2
3.3	0.1-0.2	0.2	0.3	0.4	0.5	K 3
3.4	0.1-0.2	0.2	0.3	0.4	0.5	K 4
4.1	0.1-0.2	0.2	0.2-0.3	0.3-0.4	0.3-0.4	S 1
4.2	0.1-0.2	0.2	0.2	0.3	0.3-0.4	S 2
4.3	0.1-0.2	0.2	0.2	0.3	0.3-0.4	S 3
5.1	0.1-0.2	0.2	0.2-0.3	0.3-0.4	0.4-0.5	S 1
5.2	0.1-0.2	0.2	0.2	0.3	0.3-0.4	S 2
5.3	0.1-0.2	0.2	0.2	0.3	0.3-0.4	S 3
6.1	0.1-0.2	0.2-0.3	0.3-0.4	0.4-0.5	0.5	N 3
6.2	0.1-0.2	0.2	0.2-0.3	0.3	0.3-0.4	N 4
6.3	0.1-0.2	0.2	0.2-0.3	0.3	0.3-0.4	N 3
6.4	0.1-0.2	0.2	0.2-0.3	0.3	0.3-0.4	N 4
7.1	0.1-0.2	0.2-0.3	0.3-0.4	0.4-0.5	0.5	N 1
7.2	0.1-0.2	0.2-0.3	0.3-0.4	0.4-0.5	0.5	N 1
7.3	0.1-0.2	0.2-0.3	0.3-0.4	0.4-0.5	0.5	N 1
7.4	0.1-0.2	0.2-0.3	0.3-0.4	0.4-0.5	0.5	N 2
8.1	0.1-0.2	0.3	0.4	0.4-0.5	0.5	O
8.2	0.1-0.2	0.2	0.2	0.3	0.3-0.4	O
8.3	0.1-0.2	0.2	0.2	0.3	0.3-0.4	O
9.1	0.1-0.2	0.2	0.2	0.3	0.3-0.4	H
10.1	0.1-0.2	0.2	0.2-0.3	0.3-0.4	0.4-0.5	O

对于可调铰刀或镶片铰刀，把铰削余量减少 30%；对于大螺旋角铰刀，把铰削余量增加 50% / Para alargadores ajustáveis reduza o sobremetal em 30%. Para alargadores com hélice rápida aumente em 50% / Para escariadores ajustables y con cuchillas reducir la eliminación de material un 30%. Para escariadores de hélice rápida incrementar un 50% / For adjustable or blade reamers reduce stock removal by 30%. For quick helix reamers increase by 50%

B400

HM



DIN
8093



B

H7

- 极不等距机用铰刀
- Alargador Máquina com Espaçamento Extremamente Desigual
- Escariador de máquina Espacio extremadamente irregular
- Machine Reamer Extremely unequal spacing

B400

B400	▪	1.5	1.6	3.1	3.2	3.3	3.4	4.1	4.2	4.3	5.1	5.2	5.3	6.1	6.2	6.3	6.4	7.1	7.2	7.3	7.4	
		8.1	8.2																			
	•	1.1	1.2	1.3	1.4																	

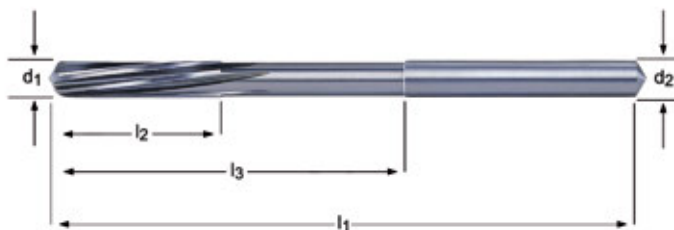

B400



1.00 - 20.00

d_1 Ø mm	l_1 mm	l_2 mm	l_3 mm	z	d_2 Ø _{h9} mm	B400
1.0	34	6	15	3	1.0	B4001.0 ¹⁾
1.2	38	8	16.5	3	1.2	B4001.2 ¹⁾
1.4	40	8	18	3	1.4	B4001.4 ¹⁾
1.5	40	8	18	3	1.5	B4001.5 ¹⁾
1.6	49	11	26	3	1.6	B4001.6 ¹⁾
1.8	49	11	25	4	1.8	B4001.8 ¹⁾
2.0	49	11	24	4	2.0	B4002.0 ¹⁾
2.2	57	15	30	4	2.2	B4002.2 ¹⁾
2.5	57	15	28	4	2.5	B4002.5 ¹⁾
2.8	61	15	32	4	2.8	B4002.8 ¹⁾
3.0	61	15	30	6	3.0	B4003.0 ¹⁾
3.2	70	18	33	6	3.2	B4003.2 ¹⁾
3.5	70	18	33	6	3.5	B4003.5 ¹⁾
4.0	75	19	44	6	4.0	B4004.0 ¹⁾
4.5	80	21	46	6	4.5	B4004.5 ¹⁾
5.0	86	23	53	6	5.0	B4005.0 ¹⁾
5.5	93	26	56	6	5.6	B4005.5 ¹⁾
6.0	93	26	56	6	5.6	B4006.0 ¹⁾
6.5	101	28	63	6	6.3	B4006.5 ²⁾
7.0	109	31	69	6	7.1	B4007.0 ²⁾
8.0	117	33	75	6	8.0	B4008.0 ²⁾
9.0	125	36	81	6	9.0	B4009.0 ²⁾
10.0	133	38	87	6	10.0	B40010.0 ²⁾
12.0	151	44	105	6	10.0	B40012.0 ²⁾
14.0	160	47	110	8	12.5	B40014.0 ²⁾
16.0	170	52	120	8	12.5	B40016.0 ²⁾
18.0	182	56	130	6	14.0	B40018.0 ³⁾
20.0	195	60	137	6	16.0	B40020.0 ³⁾

¹⁾ 整体硬质合金 / Metal Duro / Monobloc de Metal Duro / Solid Carbide

²⁾ 硬质合金刀头 / Cabeça de Metal Duro / Cabeza de Metal Duro / Carbide Head

³⁾ 硬质合金镶片 / Ponta em Metal Duro / Punta de Metal Duro / Carbide Tipped

B481



B481

- NC-用于高精度夹头以丝为单位的铰刀
- NC - Alargador Centesimal para Porta Ferramentas de Alta Precisão
- NC - Escariador Centesimal para portas de alta precisión
- NC - Centesimal Reamer for High Precision Chucks

极不等距
Espaceamento Extremamente Desigual
Espacio extremadamente irregular
Extremely unequal spacing

B481	▪	1.5	1.6	3.1	3.2	3.3	3.4	4.1	4.2	4.3	5.1	5.2	5.3	6.1	6.2	6.3	6.4	7.1	7.2	7.3	7.4	
		8.1	8.2																			
	▪	1.1	1.2	1.3	1.4																	



d_1 Ø mm	l_1 mm	l_2 mm	l_3 mm	z	d_2 Ø _{h6} mm	B481
0.98	49.5	6	21.5	3	4	B4810.98
0.99	49.5	6	21.5	3	4	B4810.99
1.00	49.5	6	21.5	3	4	B4811.00
1.01	49.5	6	21.5	3	4	B4811.01
1.02	49.5	6	21.5	3	4	B4811.02
1.03	49.5	9	21.5	3	4	B4811.03
1.48	49	9	21	3	4	B4811.48
1.49	49	9	21	3	4	B4811.49
1.50	49	9	21	3	4	B4811.50
1.51	49	9	21	3	4	B4811.51
1.52	49	9	21	3	4	B4811.52
1.53	49	9	21	3	4	B4811.53
1.98	49	12	21	4	4	B4811.98
1.99	49	12	21	4	4	B4811.99
2.00	49	12	21	4	4	B4812.00
2.01	49	12	21	4	4	B4812.01
2.02	49	12	21	4	4	B4812.02
2.03	49	12	21	4	4	B4812.03
2.48	59	16	31	4	4	B4812.48
2.49	59	16	31	4	4	B4812.49
2.50	59	16	31	4	4	B4812.50
2.51	59	16	31	4	4	B4812.51
2.52	59	16	31	4	4	B4812.52
2.53	59	16	31	4	4	B4812.53
2.97	62.5	17	35	6	4	B4812.97
2.98	62.5	17	35	6	4	B4812.98
2.99	62.5	17	35	6	4	B4812.99
3.00	62.5	17	35	6	4	B4813.00
3.01	62.5	17	35	6	4	B4813.01
3.02	62.5	17	35	6	4	B4813.02
3.03	62.5	17	35	6	4	B4813.03
3.97	75	19	47	6	4	B4813.97
3.98	75	19	47	6	4	B4813.98
3.99	75	19	47	6	4	B4813.99
4.00	75	19	47	6	4	B4814.00
4.01	75	19	47	6	4	B4814.01

d_1 Ø	l_1	l_2	l_3	z	d_2 Ø h_6	B481
mm	mm	mm	mm		mm	
4.02	75	19	47	6	4	B4814.02
4.03	75	19	47	6	4	B4814.03
4.97	86	23	50	6	6	B4814.97
4.98	86	23	50	6	6	B4814.98
4.99	86	23	50	6	6	B4814.99
5.00	86	23	50	6	6	B4815.00
5.01	86	23	50	6	6	B4815.01
5.02	86	23	50	6	6	B4815.02
5.03	86	23	50	6	6	B4815.03
5.97	93	26	57	6	6	B4815.97
5.98	93	26	57	6	6	B4815.98
5.99	93	26	57	6	6	B4815.99
6.00	93	26	57	6	6	B4816.00
6.01	93	26	57	6	6	B4816.01
6.02	93	26	57	6	6	B4816.02
6.03	93	26	57	6	6	B4816.03
7.97	117	33	81	6	8	B4817.97
7.98	117	33	81	6	8	B4817.98
7.99	117	33	81	6	8	B4817.99
8.00	117	33	81	6	8	B4818.00
8.01	117	33	81	6	8	B4818.01
8.02	117	33	81	6	8	B4818.02
8.03	117	33	81	6	8	B4818.03
8.04	117	33	81	6	8	B4818.04
9.97	133	38	93	6	10	B4819.97
9.98	133	38	93	6	10	B4819.98
9.99	133	38	93	6	10	B4819.99
10.00	133	38	93	6	10	B48110.00
10.01	133	38	93	6	10	B48110.01
10.02	133	38	93	6	10	B48110.02
10.03	133	38	93	6	10	B48110.03
10.04	133	38	93	6	10	B48110.04
10.05	133	38	93	6	10	B48110.05
11.97	151	44	106	6	12	B48111.97
11.98	151	44	106	6	12	B48111.98
11.99	151	44	106	6	12	B48111.99
12.00	151	44	106	6	12	B48112.00
12.01	151	44	106	6	12	B48112.01
12.02	151	44	106	6	12	B48112.02
12.03	151	44	106	6	12	B48112.03
12.04	151	44	106	6	12	B48112.04
12.05	151	44	106	6	12	B48112.05

B441



- 极不等距机用铰刀
- Alargador Máquina com Espaçamento Extremamente Desigual
- Escariador de máquina Espacio extremadamente irregular
- Machine Reamer Extremely unequal spacing

B441

B441	▪	1.5	1.6	3.1	3.2	3.3	3.4	4.1	4.2	4.3	5.1	5.2	5.3	6.1	6.2	6.3	6.4	7.1	7.2	7.3	7.4	
		8.1	8.2																			
	•	1.1	1.2	1.3	1.4																	

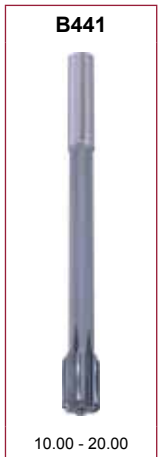
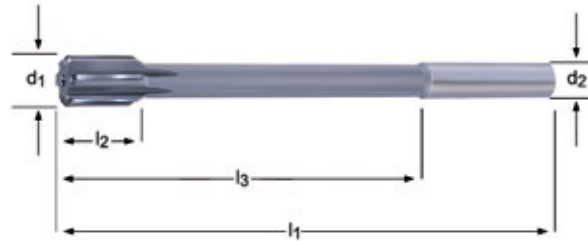

d_1 Ø mm	l_1 mm	l_2 mm	l_3 mm	z	d_2 Ø h_9 mm	B441
10.0	133	19	87	6	10	B44110.0 ³⁾
11.0	142	19	96	6	10	B44111.0 ³⁾
12.0	151	19	105	6	10	B44112.0 ³⁾
13.0	151	19	105	6	10	B44113.0 ³⁾
14.0	160	19	110	6	12.5	B44114.0 ³⁾
15.0	162	19	112	6	12.5	B44115.0 ³⁾
16.0	170	22	120	6	12.5	B44116.0 ³⁾
17.0	175	22	123	6	14	B44117.0 ³⁾
18.0	182	22	130	6	14	B44118.0 ³⁾
19.0	189	22	131	6	16	B44119.0 ³⁾
20.0	195	22	137	6	16	B44120.0 ³⁾

³⁾ 硬质合金镶片 / Ponta em Metal Duro / Punta de Metal Duro / Carbide Tipped

B411



- 极不等距机用铰刀
- Alargador Máquina com Espaçamento Extremamente Desigual
- Escariador de máquina Espacio extremadamente irregular
- Machine Reamer Extremely unequal spacing

B411

B411	▪	1.5	1.6	3.1	3.2	3.3	3.4	4.1	4.2	4.3	5.1	5.2	5.3	6.1	6.2	6.3	6.4	7.1	7.2	7.3	7.4	
		8.1	8.2																			
	•	1.1	1.2	1.3	1.4																	



d_1 Ø	l_1	l_2	l_3	z	MK	B411
mm	mm	mm	mm			
5.0	133	23	67.5	6	1	B4115.0 ²⁾
6.0	138	26	72.5	6	1	B4116.0 ²⁾
7.0	150	31	84.5	6	1	B4117.0 ²⁾
8.0	156	33	90.5	6	1	B4118.0 ²⁾
9.0	162	36	96.5	6	1	B4119.0 ²⁾
10.0	168	38	102.5	6	1	B41110.0 ²⁾
12.0	182	44	116.5	6	1	B41112.0 ²⁾
14.0	189	47	123.5	8	1	B41114.0 ²⁾
15.0	204	50	124	8	2	B41115.0 ²⁾
16.0	210	52	130	8	2	B41116.0 ²⁾
17.0	214	54	134	6	2	B41117.0 ³⁾
18.0	219	56	139	6	2	B41118.0 ³⁾
19.0	223	58	143	6	2	B41119.0 ³⁾
20.0	228	60	148	6	2	B41120.0 ³⁾
22.0	237	64	157	6	2	B41122.0 ³⁾
24.0	268	68	169	8	3	B41124.0 ³⁾
25.0	268	68	169	8	3	B41125.0 ³⁾
26.0	273	70	174	8	3	B41126.0 ³⁾
30.0	281	73	182	8	3	B41130.0 ³⁾

²⁾ 硬质合金刀头 / Ponta de Metal Duro / Cabeza de Metal Duro / Carbide Head

³⁾ 硬质合金镶片 / Ponta em Metal Duro / Punta de Metal Duro / Carbide Tipped

B442



- 极不等距机用铰刀
- Alargador Máquina com Espaçamento Extremamente Desigual
- Escariador de máquina Espacio extremadamente irregular
- Machine Reamer Extremely unequal spacing

B442

B442	▪	1.5	1.6	3.1	3.2	3.3	3.4	4.1	4.2	4.3	5.1	5.2	5.3	6.1	6.2	6.3	6.4	7.1	7.2	7.3	7.4	
		8.1	8.2																			
	•	1.1	1.2	1.3	1.4																	



d_1 Ø mm	l_1 mm	l_2 mm	l_3 mm	z	MK	B442
10.0	168	19	102.5	6	1	B44210.0
12.0	182	19	116.5	6	1	B44212.0
14.0	189	19	123.5	6	1	B44214.0
15.0	204	19	124	6	2	B44215.0
16.0	210	22	130	6	2	B44216.0
17.0	214	22	134	6	2	B44217.0
18.0	219	22	139	6	2	B44218.0
19.0	223	22	143	6	2	B44219.0
20.0	228	22	148	6	2	B44220.0

B100

HSS



DIN 206



B

H7

- 手用铰刀
- Alargador Manual
- Escariador de mano
- Hand Reamer

d2 = d1, 公差为 e9
 d2=d1 com tolerância e9
 d2=d1 Tolerancia e9
 d2=d1 with tolerance e9

B100

B100	▪	1.1	1.2	1.3	1.4	2.1	3.1	4.1	6.2							
	•	1.5	1.6	3.2	3.3	3.4	4.2	4.3	5.1	5.2	5.3	6.1	6.3	6.4	7.1	7.2



B100



1.50 - 50.00

d ₁ Ø Inch	d ₁ Ø mm	l ₁ mm	l ₂ mm	l ₃ mm	z	□ a mm	B100
	1.50	41	20	5	3	1.12	B1001.5
1/16	1.59	41	20	5	3	1.12	B1001/16
	1.60	44	21	5	3	1.25	B1001.6
5/64	1.98	47	23	6	4	1.40	B1005/64
	2.00	50	25	6	4	1.60	B1002.0
3/32	2.38	54	27	7	4	1.80	B1003/32
	2.50	58	29	7	4	2.10	B1002.5
7/64	2.78	62	31	8	6	2.10	B1007/64
	3.00	62	31	8	6	2.40	B1003.0
1/8	3.18	66	33	8	6	2.40	B1001/8
	3.20	66	33	8	6	2.40	B1003.2
	3.50	71	35	9	6	2.70	B1003.5
9/64	3.57	71	35	9	6	2.70	B1009/64
5/32	3.97	76	38	10	6	3.00	B1005/32
	4.00	76	38	10	6	3.00	B1004.0
11/64	4.37	81	41	10	6	3.40	B10011/64
	4.50	81	41	10	6	3.40	B1004.5
3/16	4.76	87	44	11	6	3.80	B1003/16
	5.00	87	44	11	6	3.80	B1005.0
13/64	5.16	87	44	11	6	3.80	B10013/64
	5.50	93	47	12	6	4.30	B1005.5
7/32	5.56	93	47	12	6	4.30	B1007/32
15/64	5.95	93	47	12	6	4.90	B10015/64
	6.00	93	47	12	6	4.90	B1006.0
1/4	6.35	100	50	13	6	4.90	B1001/4
	6.50	100	50	13	6	4.90	B1006.5
17/64	6.75	107	54	14	6	5.50	B10017/64
	7.00	107	54	14	6	5.50	B1007.0
9/32	7.14	107	54	14	6	6.20	B1009/32
	7.50	107	54	14	6	6.20	B1007.5
19/64	7.54	115	58	15	6	6.20	B10019/64
5/16	7.94	115	58	15	6	6.20	B1005/16
	8.00	115	58	15	6	6.20	B1008.0
21/64	8.33	115	58	15	6	7.00	B10021/64
	8.50	115	58	15	6	7.00	B1008.5
11/32	8.73	124	62	16	6	7.00	B10011/32
	9.00	124	62	16	6	7.00	B1009.0
23/64	9.13	124	62	16	6	8.00	B10023/64

d_1 Ø Inch	d_1 Ø mm	l_1 mm	l_2 mm	l_3 mm	z	\square a mm	B100
	9.50	124	62	16	6	8.00	B1009.5
3/8	9.52	124	62	17	6	8.00	B1003/8
25/64	9.92	133	66	17	6	8.00	B10025/64
	10.00	133	66	17	6	8.00	B10010.0
13/32	10.32	133	66	17	6	8.00	B10013/32
	10.50	133	66	17	6	8.00	B10010.5
	11.00	142	71	18	6	9.00	B10011.0
7/16	11.11	142	71	18	6	9.00	B1007/16
	11.50	142	71	18	6	9.00	B10011.5
	12.00	152	76	19	6	9.00	B10012.0
	12.50	152	76	19	6	10.00	B10012.5
1/2	12.70	152	76	19	6	10.00	B1001/2
	13.00	152	76	19	6	10.00	B10013.0
17/32	13.49	163	81	20	8	11.00	B10017/32
	13.50	163	81	20	8	11.00	B10013.5
	14.00	163	81	20	8	11.00	B10014.0
9/16	14.29	163	81	20	8	11.00	B1009/16
	14.50	163	81	20	8	11.00	B10014.5
	15.00	163	81	20	8	12.00	B10015.0
19/32	15.08	163	81	22	8	12.00	B10019/32
5/8	15.88	175	87	22	8	12.00	B1005/8
	16.00	175	87	22	8	12.00	B10016.0
	17.00	175	87	22	8	13.00	B10017.0
11/16	17.46	188	93	23	8	14.50	B10011/16
	18.00	188	93	23	8	14.50	B10018.0
	19.00	188	93	23	8	14.50	B10019.0
3/4	19.05	188	93	25	8	14.50	B1003/4
	20.00	201	100	25	8	16.00	B10020.0
13/16	20.64	201	100	25	8	16.00	B10013/16
	21.00	201	100	25	8	16.00	B10021.0
	22.00	215	107	27	8	18.00	B10022.0
7/8	22.22	215	107	27	8	18.00	B1007/8
	23.00	215	107	27	8	18.00	B10023.0
	24.00	231	115	29	8	18.00	B10024.0
	25.00	231	115	29	8	20.00	B10025.0
1"	25.40	231	115	29	8	20.00	B1001
	26.00	231	115	29	8	20.00	B10026.0
	27.00	247	124	31	10	22.00	B10027.0
	28.00	247	124	31	10	22.00	B10028.0
	29.00	247	124	31	10	22.00	B10029.0
	30.00	247	124	31	10	24.00	B10030.0
	31.00	265	133	33	10	24.00	B10031.0
	32.00	265	133	33	10	24.00	B10032.0
	33.00	265	133	33	10	26.00	B10033.0
	34.00	284	142	36	10	26.00	B10034.0
	35.00	284	142	36	10	29.00	B10035.0
	36.00	284	142	36	10	29.00	B10036.0
	37.00	284	142	36	10	29.00	B10037.0
	38.00	305	152	38	10	29.00	B10038.0
	39.00	305	152	38	10	32.00	B10039.0
	40.00	305	152	38	10	32.00	B10040.0
	45.00	326	163	41	12	35.00	B10045.0
	50.00	347	174	44	12	39.00	B10050.0

B334

HSS



- 手用快调铰刀
- Alargador Manual Ajuste Rápido
- Escariador de mano Extensibles
- Hand Reamer Quickly Adjustable

B334

B334	▪	1.1	1.2	1.3	1.4	2.1	3.1	4.1	6.2							
	•	1.5	1.6	3.2	3.3	3.4	4.2	4.3	5.1	5.2	5.3	6.1	6.3	6.4	7.1	7.2



B334



N000 - N16

Nr.	d min-max mm	l ₁ mm	l ₂ mm	l ₃ mm	z	∇ a mm	B334
000	6.4 - 7.2	110	32	7	4	3.0	B334000
00	7.2 - 8.0	110	32	7	4	3.4	B33400
0	8.0 - 9.0	115	34	9	5	3.8	B3340
1	9.0 - 10.0	115	34	9	5	4.3	B3341
2	10.0 - 11.0	115	34	9	5	4.9	B3342
3	11.0 - 12.0	125	35	9	5	4.9	B3343
4	12.0 - 13.5	135	41	9	5	6.2	B3344
5	13.5 - 15.5	146	50	12	5	7.0	B3345
6	15.5 - 18.0	166	60	12	5	8.0	B3346
7	18.0 - 21.0	178	65	15	5	9.0	B3347
8	21.0 - 24.0	195	76	15	5	11.0	B3348
9	24.0 - 27.5	218	82	18	5	12.0	B3349
10	27.5 - 31.5	245	86	18	5	14.5	B33410
11	31.5 - 37.0	280	98	18	6	18.0	B33411
12	37.0 - 45.0	325	108	20	6	20.0	B33412
13	45.0 - 55.0	370	118	20	6	26.0	B33413
14	55.0 - 67.0	400	125	20	6	32.0	B33414
15	67.0 - 80.0	435	140	23	8	39.0	B33415
16	80.0 - 95.0	475	155	23	8	49.0	B33416

B335

HSS

DORMER

- 手用快调铰刀配件 (B334)
- Alargador Manual Ajuste Rápido - Acessórios (B334)
- Accesorios para el porta-escariador tipo B334
- Hand Reamer Quickly Adjustable - Spare Parts (B334)

B335



BLADES



NUT

B335



N000BLADES - N16NUT

Nr.	B335
000	B335000BLADES
000	B335000NUT
00	B33500BLADES
00	B33500NUT
0	B3350BLADES
0	B3350NUT
1	B3351BLADES
1	B3351NUT
2	B3352BLADES
2	B3352NUT
3	B3353BLADES
3	B3353NUT
4	B3354BLADES
4	B3354NUT
5	B3355BLADES
5	B3355NUT
6	B3356BLADES
6	B3356NUT
7	B3357BLADES
7	B3357NUT
8	B3358BLADES
8	B3358NUT
9	B3359BLADES
9	B3359NUT
10	B33510BLADES
10	B33510NUT
11	B33511BLADES
11	B33511NUT
12	B33512BLADES
12	B33512NUT
13	B33513BLADES
13	B33513NUT
14	B33514BLADES
14	B33514NUT
15	B33515BLADES
15	B33515NUT
16	B33516BLADES
16	B33516NUT

B901



B901

- 机用铰刀
- Alargador Máquina
- Escariador de máquina
- Machine Reamer

$d_2 = d_1 - 0.025$
 $d_2 = d_1 - 0.025$
 $d_2 = d_1 - 0.025$
 $d_2 = d_1 - 0.025$

B901	▪	1.1	1.2	1.3	1.4	2.1	3.1	4.1	6.2							
	•	1.5	1.6	3.2	3.3	3.4	4.2	4.3	5.1	5.2	5.3	6.1	6.3	6.4	7.1	7.2



d_1 Ø Inch	d_1 Ø mm	l_1 mm	l_2 mm	z	B901
	1.50	44	21	4	B9011.5
1/16	1.59	44	21	4	B9011/16
	2.00	50	25	4	B9012.0
3/32	2.38	58	29	4	B9013/32
	2.50	58	29	4	B9012.5
	3.00	62	31	4	B9013.0
1/8	3.18	66	33	4	B9011/8
	3.50	71	35	4	B9013.5
5/32	3.97	76	38	6	B9015/32
	4.00	76	38	6	B9014.0
	4.50	81	41	6	B9014.5
3/16	4.76	87	44	6	B9013/16
	5.00	87	44	6	B9015.0
13/64	5.16	87	44	6	B90113/64
	5.50	93	47	6	B9015.5
7/32	5.56	93	47	6	B9017/32
15/64	5.95	93	47	6	B90115/64
	6.00	93	47	6	B9016.0
1/4	6.35	100	50	6	B9011/4
	7.00	107	54	6	B9017.0
9/32	7.14	107	54	6	B9019/32
5/16	7.94	115	58	6	B9015/16
	8.00	115	58	6	B9018.0
	9.00	124	62	6	B9019.0
3/8	9.52	133	66	6	B9013/8
	10.00	133	66	6	B90110.0
	11.00	142	71	6	B90111.0
7/16	11.11	142	71	6	B9017/16
	12.00	152	76	6	B90112.0
1/2	12.70	152	76	6	B9011/2

B301



- 手用锥销铰刀
- Alargador Manual para Pino Cônico
- Escariador de mano para pasadores cónicos
- Hand Taper Pin Reamer

B301

B301	▪	1.1	1.2	1.3	1.4	2.1	3.1	4.1	6.2											
	•	1.5	1.6	2.2	2.3	3.2	3.3	3.4	4.2	4.3	5.1	6.1	6.3	6.4	7.1	7.2	7.3	7.4	8.2	



nom Ø	d ₁ Ø mm	l ₁ mm	l ₂ mm	z	∇ a mm	d ₂ Ø mm	B301
1/16	1.10	51	25	4	1.2	1.63	B3011/16 ⁴⁾
5/64	1.50	51	25	4	1.6	2.03	B3015/64 ⁴⁾
3/32	1.75	57	32	4	2.0	2.41	B3013/32 ⁴⁾
7/64	2.03	64	38	4	2.2	2.82	B3017/64 ⁴⁾
1/8	2.30	70	44	4	2.5	3.23	B3011/8 ⁴⁾
9/64	2.64	73	48	4	2.8	3.63	B3019/64 ⁴⁾
5/32	2.95	76	51	4	3.1	4.01	B3015/32 ⁴⁾
11/64	3.23	89	57	4	3.6	4.42	B30111/64 ⁴⁾
3/16	3.50	102	70	4	4.0	4.95	B3013/16 ⁴⁾
7/32	4.13	102	70	6	4.5	5.59	B3017/32 ⁴⁾
1/4	4.64	117	86	6	5.0	6.43	B3011/4 ⁵⁾
9/32	5.23	143	105	6	5.6	7.42	B3019/32 ⁵⁾
5/16	5.84	143	105	6	6.3	8.03	B3015/16 ⁵⁾
11/32	6.43	152	114	6	7.1	8.81	B30111/32 ⁵⁾
3/8	7.03	165	127	6	8.0	9.68	B3013/8 ⁵⁾
13/32	7.42	191	146	6	8.0	10.46	B30113/32 ⁵⁾
7/16	8.21	191	146	6	9.0	11.25	B3017/16 ⁵⁾
1/2	9.41	210	165	6	10.0	12.85	B3011/2 ⁵⁾

⁴⁾ 公差极限 + 0.0030 / Limite de tolerância +0.0030 / Límite de tolerancia +0.0030 / Limit of tolerance +0.0030

⁵⁾ 公差极限 + 0.0050 / Limite de tolerância +0.0050 / Límite de tolerancia +0.0050 / Limit of tolerance +0.0050

B903



- 手用锥销铰刀
- Alargador Manual para Pino Cônico
- Escariador de mano para pasadores cónicos
- Hand Taper Pin Reamer

B903

B903	■	1.1	1.2	1.3	1.4	2.1	3.1	4.1	6.2										
	•	1.5	1.6	2.2	2.3	3.2	3.3	3.4	4.2	4.3	5.1	6.1	6.3	6.4	7.1	7.2	7.3	7.4	8.2



nom Ø	d ₁ Ø mm	d ₂ Ø mm	l ₁ mm	l ₂ mm	z	∠ a mm	d ₃ Ø _{h₁₁} mm	B903
1.5	1.40	2.14	57	37	4	1.80	2.14	B9031.5 ⁶⁾
2.0	1.90	2.86	68	48	4	2.24	2.86	B9032.0 ⁶⁾
2.5	2.40	3.36	68	48	4	2.80	3.36	B9032.5 ⁶⁾
3.0	2.90	4.06	80	58	4	3.15	4.00	B9033.0 ⁶⁾
4.0	3.90	5.26	93	68	4	4.00	5.00	B9034.0 ⁶⁾
5.0	4.90	6.36	100	73	4	5.00	6.30	B9035.0 ⁶⁾
6.0	5.90	8.00	135	105	6	6.30	7.90	B9036.0 ⁷⁾
8.0	7.90	10.80	180	145	6	8.00	10.50	B9038.0 ⁷⁾
10.0	9.90	13.40	215	175	6	10.00	13.30	B90310.0 ⁷⁾
12.0	11.80	16.00	255	210	8	11.20	16.00	B90312.0 ⁷⁾
13.0	12.86	16.74	255	210	8	12.50	16.74	B90313.0 ⁷⁾
14.0	13.86	17.74	255	210	8	12.50	17.74	B90314.0 ⁷⁾
16.0	15.80	20.40	280	230	8	14.00	20.40	B90316.0 ⁷⁾
20.0	19.80	24.80	310	250	8	18.00	24.80	B90320.0 ⁷⁾

⁶⁾ 公差极限 + 0.0750 / Limite de tolerância +0.0750 / Límite de tolerancia +0.0750 / Limit of tolerance +0.0750

⁷⁾ 公差极限 + 0.125 / Limite de tolerância +0.125 / Límite de tolerancia +0.125 / Limit of tolerance +0.125

B952



- 手用锥销铰刀
- Alargador Manual para Pino Cônico
- Escariador de mano para pasadores cónicos
- Hand Taper Pin Reamer

B952

B952	▪	1.1	1.2	1.3	1.4	2.1	3.1	4.1	6.2									
	•	1.5	1.6	2.2	2.3	3.2	3.3	3.4	4.2	4.3	5.1	6.1	6.3	6.4	7.1	7.2	7.3	7.4



nom Ø	d ₁ Ø mm	d ₂ Ø mm	l ₁ mm	l ₂ mm	z	☐ a mm	d ₃ Øh ₁₁ mm	B952
1.2	1.1	1.74	50	32	3	2.4	3.15	B9521.2 ⁸⁾
1.5	1.4	2.14	57	37	3	2.4	3.15	B9521.5 ⁸⁾
2.0	1.9	2.86	68	48	3	2.4	3.15	B9522.0 ⁸⁾
2.5	2.4	3.36	68	48	4	2.4	3.15	B9522.5 ⁸⁾
3.0	2.9	4.06	80	58	5	3.0	4.00	B9523.0
3.5	3.4	4.66	87	63	5	3.4	4.50	B9523.5
4.0	3.9	5.26	93	68	5	3.8	5.00	B9524.0
4.5	4.4	5.80	95	70	5	4.3	5.60	B9524.5
5.0	4.9	6.36	100	73	5	4.9	6.30	B9525.0
5.5	5.4	7.20	118	90	6	5.5	7.10	B9525.5
6.0	5.9	8.00	135	105	6	6.2	8.00	B9526.0
6.5	6.4	8.60	140	110	6	6.2	8.00	B9526.5
7.0	6.9	9.40	160	125	6	7.0	9.00	B9527.0
8.0	7.9	10.8	180	145	6	8.0	10.00	B9528.0
9.0	8.9	12.1	195	160	6	9.0	11.20	B9529.0
10.0	9.9	13.4	215	175	6	10.0	12.50	B95210.0
12.0	11.8	16.0	255	210	8	11.0	14.00	B95212.0
13.0	12.8	17.0	255	210	8	12.0	16.00	B95213.0
14.0	13.8	18.0	255	210	8	12.0	16.00	B95214.0
16.0	15.8	20.4	280	230	8	14.5	18.00	B95216.0
20.0	19.8	24.8	310	250	8	18.0	22.40	B95220.0
25.0	24.7	30.7	370	300	10	22.0	28.00	B95225.0
30.0	29.7	36.1	400	320	10	24.0	31.50	B95230.0
40.0	39.7	46.5	430	340	12	32.0	40.00	B95240.0
50.0	49.7	56.9	460	360	12	39.0	50.00	B95250.0

⁸⁾ 直槽, A 型 / Canal Reto, forma A / Estrias rectas, forma A / Straight Flute, form A

B122



- 左螺旋槽铰刀
- Alargador Piloto Canal Helicoidal
- Escariadores de máquina rectos
- Straight Car Reamers, LH Helical Flute

B122

B122	▪	1.1	1.2	1.3	1.4	2.1	3.1	4.1	6.2										
	•	1.5	1.6	2.2	2.3	3.2	3.3	3.4	4.2	4.3	5.1	6.1	6.3	6.4	7.1	7.2	7.3	7.4	8.2

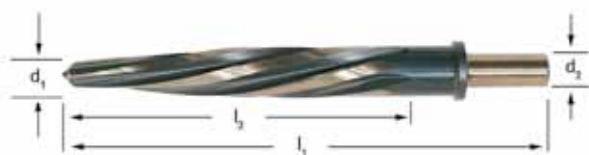

d_1 Ø Inch	d_1 decimal Inch	l_1 Inch	l_2 Inch	z	d_2 Ø Inch	B122
3/8	0.3750	4.5/8	2.1/2	4	3/8	B1223/8
1/2	0.5000	5.7/8	3.3/4	5	1/2	B1221/2
9/16	0.5625	5.7/8	3.3/4	5	1/2	B1229/16
5/8	0.6250	6.3/8	4.1/4	5	1/2	B1225/8
11/16	0.6875	6.3/8	4.1/4	5	1/2	B12211/16
3/4	0.7500	6.7/8	4.1/2	5	1/2	B1223/4
13/16	0.8125	6.7/8	4.1/2	5	1/2	B12213/16
7/8	0.8750	6.7/8	4.1/2	5	1/2	B1227/8
15/16	0.9375	6.7/8	4.1/2	5	1/2	B12215/16
1"	1.0000	6.7/8	4.1/2	5	1/2	B1221
1.1/16	1.0625	6.7/8	4.1/2	5	1/2	B1221.1/16

B953



B953

- 45 度左螺旋圆锥销机用铰刀
- Alargador Máquina para pinos cónicos com corte a esquerda - Hélice 45°
- Escariador de máquina para pasadores cónicos Hélice a izquierdas 45°
- Machine Reamer for Conical Pin Left Hand Helix 45°

扁尾符合 DIN 1809
 Arraste de acordo com a DIN 1809
 Lengüeta según DIN 1809
 Tang to DIN 1809

B953	▪	2.1	2.2	2.3	4.1	4.2	4.3	5.1	5.2	5.3	6.1	7.1	7.2	7.3	7.4	8.1
	•	1.1	1.2	1.3	1.4	1.5	1.6	6.2	9.1							



1.00 - 12.00

nom Ø	d ₁ Ø mm	d ₂ Ø mm	l ₁ mm	l ₂ mm	z	d ₃ Øh ₃ mm	B953
1.0	0.8	1.46	60	33	2	1.4	B9531.0
1.5	1.4	2.14	70	37	2	2.1	B9531.5
2.0	1.9	2.86	86	48	3	3.15	B9532.0
2.5	2.4	3.36	86	48	3	3.15	B9532.5
3.0	2.9	4.06	100	58	3	4.0	B9533.0
4.0	3.9	5.26	112	68	3	5.0	B9534.0
5.0	4.9	6.36	122	73	3	6.3	B9535.0
6.0	5.9	8.00	160	105	3	8.0	B9536.0
6.5	6.4	8.78	188	119	3	8.5	B9536.5
8.0	7.9	10.80	207	145	3	10.0	B9538.0
10.0	9.9	13.40	245	175	3	12.5	B95310.0
12.0	11.8	16.00	290	210	3	16.0	B95312.0

B180



- NC-用于高精度夹头的铰刀
- NC - Alargador para mandris de alta precisão
- NC- Escariador de precisión
- NC - Reamer for High Precision Chucks

B180

B180	▪	1.1	1.2	1.3	1.4	2.1	4.2	5.1										
	•	1.5	1.6	2.2	2.3	2.4	3.1	3.2	3.3	3.4	4.1	4.3	5.2	5.3	6.1	6.2	6.3	6.4



d_1 Ø mm	l_1 mm	l_2 mm	l_3 mm	z	d_2 Ø _{h6} mm	B180
1.5	40	8	18	3	2	B1801.5
1.6	43	9	20	3	2	B1801.6
1.7	43	9	20	3	2	B1801.7
1.8	46	10	22	4	2	B1801.8
1.9	46	10	22	4	2	B1801.9
2.0	49	11	24	4	2	B1802.0
2.1	49	11	24	4	2	B1802.1
2.2	53	12	26	4	3	B1802.2
2.3	53	12	26	4	3	B1802.3
2.4	57	14	28	4	3	B1802.4
2.5	57	14	28	4	3	B1802.5
2.6	57	14	28	4	3	B1802.6
2.7	61	15	32	6	3	B1802.7
2.8	61	15	32	6	3	B1802.8
2.9	61	15	32	6	3	B1802.9
3.0	61	15	32	6	3	B1803.0
3.1	65	16	35	6	4	B1803.1
3.2	65	16	35	6	4	B1803.2
3.3	65	16	35	6	4	B1803.3
3.4	70	18	40	6	4	B1803.4
3.5	70	18	40	6	4	B1803.5
3.6	70	18	40	6	4	B1803.6
3.7	70	18	40	6	4	B1803.7
3.8	75	19	43	6	4	B1803.8
3.9	75	19	43	6	4	B1803.9
4.0	75	19	43	6	4	B1804.0
4.1	75	19	43	6	4	B1804.1
4.2	75	19	43	6	4	B1804.2
4.3	80	21	47	6	5	B1804.3
4.4	80	21	47	6	5	B1804.4
4.5	80	21	47	6	5	B1804.5
4.6	80	21	47	6	5	B1804.6
4.7	80	21	47	6	5	B1804.7
4.8	86	23	52	6	5	B1804.8
4.9	86	23	52	6	5	B1804.9
5.0	86	23	52	6	5	B1805.0
5.1	86	23	52	6	5	B1805.1
5.2	86	23	52	6	5	B1805.2

d_1 \emptyset mm	l_1 mm	l_2 mm	l_3 mm	z	d_2 $\emptyset h_6$ mm	B180
5.3	86	23	52	6	5	B1805.3
5.4	93	26	57	6	6	B1805.4
5.5	93	26	57	6	6	B1805.5
5.6	93	26	57	6	6	B1805.6
5.7	93	26	57	6	6	B1805.7
5.8	93	26	57	6	6	B1805.8
5.9	93	26	57	6	6	B1805.9
6.0	93	26	57	6	6	B1806.0
6.1	101	28	63	6	6	B1806.1
6.2	101	28	63	6	6	B1806.2
6.3	101	28	63	6	6	B1806.3
6.4	101	28	63	6	6	B1806.4
6.5	101	28	63	6	6	B1806.5
6.6	101	28	63	6	6	B1806.6
6.7	101	28	63	6	6	B1806.7
6.8	109	31	69	6	8	B1806.8
6.9	109	31	69	6	8	B1806.9
7.0	109	31	69	6	8	B1807.0
7.1	109	31	69	6	8	B1807.1
7.2	109	31	69	6	8	B1807.2
7.3	109	31	69	6	8	B1807.3
7.4	109	31	69	6	8	B1807.4
7.5	109	31	69	6	8	B1807.5
7.6	117	33	75	6	8	B1807.6
7.7	117	33	75	6	8	B1807.7
7.8	117	33	75	6	8	B1807.8
7.9	117	33	75	6	8	B1807.9
8.0	117	33	75	6	8	B1808.0
8.1	117	33	75	6	8	B1808.1
8.2	117	33	75	6	8	B1808.2
8.3	117	33	75	6	8	B1808.3
8.4	117	33	75	6	8	B1808.4
8.5	117	33	75	6	8	B1808.5
8.6	125	36	81	6	10	B1808.6
8.7	125	36	81	6	10	B1808.7
8.8	125	36	81	6	10	B1808.8
8.9	125	36	81	6	10	B1808.9
9.0	125	36	81	6	10	B1809.0
9.1	125	36	81	6	10	B1809.1
9.2	125	36	81	6	10	B1809.2
9.3	125	36	81	6	10	B1809.3
9.4	125	36	81	6	10	B1809.4
9.5	125	36	81	6	10	B1809.5
9.6	133	38	87	6	10	B1809.6
9.7	133	38	87	6	10	B1809.7
9.8	133	38	87	6	10	B1809.8
9.9	133	38	87	6	10	B1809.9
10.0	133	38	87	6	10	B18010.0
11.0	142	41	96	6	10	B18011.0
12.0	151	44	105	6	10	B18012.0
13.0	151	44	105	6	10	B18013.0
14.0	160	47	110	8	14	B18014.0
15.0	162	50	112	8	14	B18015.0
16.0	170	52	120	8	14	B18016.0
17.0	175	54	123	8	14	B18017.0
18.0	182	56	130	8	14	B18018.0
19.0	189	58	131	8	16	B18019.0
20.0	195	60	137	8	16	B18020.0

B170



- 以丝为单位的机用铰刀
- Alargador máquina centesimal
- Escariador de máquina centesimal
- Machine Centesimal Reamer

B170

B170	▪	1.1	1.2	1.3	1.4	2.1	4.2	5.1								
	•	1.5	1.6	2.2	2.3	3.1	3.2	3.3	3.4	4.1	4.3	5.2	5.3	6.1	6.2	6.3



d_1 Ø	l_1	l_2	l_3	z	d_2 Ø _{h9}	B170
mm	mm	mm	mm		mm	
0.98	34	5.5	15	3	1.0	B170.98
0.99	34	5.5	15	3	1.0	B170.99
1.00	34	5.5	15	3	1.0	B1701.0
1.01	34	5.5	15	3	1.0	B1701.01
1.02	34	5.5	15	3	1.0	B1701.02
1.03	34	5.5	15	3	1.0	B1701.03
1.04	34	5.5	15	3	1.0	B1701.04
1.05	34	5.5	15	3	1.0	B1701.05
1.49	40	8.0	18	3	1.5	B1701.49
1.50	40	8.0	18	3	1.5	B1701.5
1.51	43	9.0	20	3	1.6	B1701.51
1.52	43	9.0	20	3	1.6	B1701.52
1.98	49	11.0	24	4	2.0	B1701.98
1.99	49	11.0	24	4	2.0	B1701.99
2.00	49	11.0	24	4	2.0	B1702.0
2.01	49	11.0	24	4	2.0	B1702.01
2.02	49	11.0	24	4	2.0	B1702.02
2.03	49	11.0	24	4	2.0	B1702.03
2.04	49	11.0	24	4	2.0	B1702.04
2.05	49	11.0	24	4	2.0	B1702.05
2.49	57	14.0	28	4	2.5	B1702.49
2.50	57	14.0	28	4	2.5	B1702.5
2.51	57	14.0	28	4	2.5	B1702.51
2.52	57	14.0	28	4	2.5	B1702.52
2.98	61	15.0	32	6	3.0	B1702.98
2.99	61	15.0	32	6	3.0	B1702.99
3.00	61	15.0	32	6	3.0	B1703.0
3.01	65	16.0	35	6	3.2	B1703.01
3.02	65	16.0	35	6	3.2	B1703.02
3.03	65	16.0	35	6	3.2	B1703.03
3.04	65	16.0	35	6	3.2	B1703.04
3.05	65	16.0	35	6	3.2	B1703.05
3.49	70	18.0	40	6	3.5	B1703.49
3.50	70	18.0	40	6	3.5	B1703.5
3.51	70	18.0	40	6	3.5	B1703.51
3.52	70	18.0	40	6	3.5	B1703.52
3.98	75	19.0	43	6	4.0	B1703.98
3.99	75	19.0	43	6	4.0	B1703.99

d_1 Ø mm	l_1 mm	l_2 mm	l_3 mm	z	d_2 Ø h_3 mm	B170
4.00	75	19.0	43	6	4.0	B1704.0
4.01	75	19.0	43	6	4.0	B1704.01
4.02	75	19.0	43	6	4.0	B1704.02
4.03	75	19.0	43	6	4.0	B1704.03
4.04	75	19.0	43	6	4.0	B1704.04
4.05	75	19.0	43	6	4.0	B1704.05
4.49	80	21.0	47	6	4.5	B1704.49
4.50	80	21.0	47	6	4.5	B1704.5
4.51	80	21.0	47	6	4.5	B1704.51
4.52	80	21.0	47	6	4.5	B1704.52
4.98	86	23.0	52	6	5.0	B1704.98
4.99	86	23.0	52	6	5.0	B1704.99
5.00	86	23.0	52	6	5.0	B1705.0
5.01	86	23.0	52	6	5.0	B1705.01
5.02	86	23.0	52	6	5.0	B1705.02
5.03	86	23.0	52	6	5.0	B1705.03
5.04	86	23.0	52	6	5.0	B1705.04
5.05	86	23.0	52	6	5.0	B1705.05
5.49	93	26.0	57	6	5.6	B1705.49
5.50	93	26.0	57	6	5.6	B1705.5
5.51	93	26.0	57	6	5.6	B1705.51
5.52	93	26.0	57	6	5.6	B1705.52
5.98	93	26.0	57	6	5.6	B1705.98
5.99	93	26.0	57	6	5.6	B1705.99
6.00	93	26.0	57	6	5.6	B1706.0
6.01	101	28.0	63	6	6.3	B1706.01
6.02	101	28.0	63	6	6.3	B1706.02
6.03	101	28.0	63	6	6.3	B1706.03
6.04	101	28.0	63	6	6.3	B1706.04
6.05	101	28.0	63	6	6.3	B1706.05
6.49	101	28.0	63	6	6.3	B1706.49
6.50	101	28.0	63	6	6.3	B1706.5
6.51	101	28.0	63	6	6.3	B1706.51
6.52	101	28.0	63	6	6.3	B1706.52
6.98	109	31.0	69	6	7.1	B1706.98
6.99	109	31.0	69	6	7.1	B1706.99
7.00	109	31.0	69	6	7.1	B1707.0
7.01	109	31.0	69	6	7.1	B1707.01
7.02	109	31.0	69	6	7.1	B1707.02
7.03	109	31.0	69	6	7.1	B1707.03
7.04	109	31.0	69	6	7.1	B1707.04
7.05	109	31.0	69	6	7.1	B1707.05
7.49	109	31.0	69	6	7.1	B1707.49
7.50	109	31.0	69	6	7.1	B1707.5
7.51	117	33.0	75	6	8.0	B1707.51
7.52	117	33.0	75	6	8.0	B1707.52
7.98	117	33.0	75	6	8.0	B1707.98
7.99	117	33.0	75	6	8.0	B1707.99
8.00	117	33.0	75	6	8.0	B1708.0
8.01	117	33.0	75	6	8.0	B1708.01
8.02	117	33.0	75	6	8.0	B1708.02
8.03	117	33.0	75	6	8.0	B1708.03
8.04	117	33.0	75	6	8.0	B1708.04
8.05	117	33.0	75	6	8.0	B1708.05
8.49	117	33.0	75	6	8.0	B1708.49
8.50	117	33.0	75	6	8.0	B1708.5
8.51	125	36.0	81	6	9.0	B1708.51
8.52	125	36.0	81	6	9.0	B1708.52
8.98	125	36.0	81	6	9.0	B1708.98
8.99	125	36.0	81	6	9.0	B1708.99
9.00	125	36.0	81	6	9.0	B1709.0
9.01	125	36.0	81	6	9.0	B1709.01
9.02	125	36.0	81	6	9.0	B1709.02
9.03	125	36.0	81	6	9.0	B1709.03
9.04	125	36.0	81	6	9.0	B1709.04
9.05	125	36.0	81	6	9.0	B1709.05
9.49	125	36.0	81	6	9.0	B1709.49
9.50	125	36.0	81	6	9.0	B1709.5
9.51	133	38.0	87	6	10.0	B1709.51
9.52	133	38.0	87	6	10.0	B1709.52

d_1 Ø mm	l_1 mm	l_2 mm	l_3 mm	z	d_2 Ø h_9 mm	B170
9.98	133	38.0	87	6	10.0	B1709.98
9.99	133	38.0	87	6	10.0	B1709.99
10.00	133	38.0	87	6	10.0	B17010.0
10.01	133	38.0	87	6	10.0	B17010.01
10.02	133	38.0	87	6	10.0	B17010.02
10.03	133	38.0	87	6	10.0	B17010.03
10.04	133	38.0	87	6	10.0	B17010.04
10.05	133	38.0	87	6	10.0	B17010.05
10.49	133	38.0	87	6	10.0	B17010.49
10.50	133	38.0	87	6	10.0	B17010.5
10.51	133	38.0	87	6	10.0	B17010.51
10.52	133	38.0	87	6	10.0	B17010.52
10.98	142	41.0	96	6	10.0	B17010.98
10.99	142	41.0	96	6	10.0	B17010.99
11.00	142	41.0	96	6	10.0	B17011.0
11.01	142	41.0	96	6	10.0	B17011.01
11.02	142	41.0	96	6	10.0	B17011.02
11.03	142	41.0	96	6	10.0	B17011.03
11.04	142	41.0	96	6	10.0	B17011.04
11.05	142	41.0	96	6	10.0	B17011.05
11.49	142	41.0	96	6	10.0	B17011.49
11.50	142	41.0	96	6	10.0	B17011.5
11.51	142	41.0	96	6	10.0	B17011.51
11.52	142	41.0	96	6	10.0	B17011.52
11.98	151	44.0	105	6	10.0	B17011.98
11.99	151	44.0	105	6	10.0	B17011.99
12.00	151	44.0	105	6	10.0	B17012.0

B157



- 45 度左螺旋机用铰刀
- Alargador Máquina com corte a esquerda - Hélice 45°
- Escariador de máquina Hélice a izquierdas 45°
- Machine Reamer Left Hand Helix 45°

B157

B157	▪	1.1	1.2	1.3	1.4	2.1	2.2	2.3	4.1	4.2	4.3	5.1	5.2	5.3	6.1	7.1	7.2	7.3	7.4	8.1
	•	1.5	1.6	6.2	9.1															



d_1 \varnothing mm	l_1 mm	l_2 mm	l_3 mm	l_4 mm	z	d_2 $\varnothing h_9$ mm	B157
2.0	49	11	3.5	24	3	2.0	B1572.0
3.0	61	15	4.0	32	3	3.0	B1573.0
4.0	75	19	4.0	43	3	4.0	B1574.0
5.0	86	23	4.5	52	3	5.0	B1575.0
6.0	93	26	6.0	57	3	5.6	B1576.0
7.0	109	31	7.0	69	3	7.1	B1577.0
8.0	117	33	9.0	75	3	8.0	B1578.0
9.0	125	36	9.5	81	3	9.0	B1579.0
10.0	133	38	10.0	87	3	10.0	B15710.0
11.0	142	41	10.5	96	3	10.0	B15711.0
12.0	151	44	11.0	105	3	10.0	B15712.0
13.0	151	44	11.5	105	3	10.0	B15713.0
14.0	160	47	12.0	110	3	12.5	B15714.0
15.0	162	50	12.5	112	3	12.5	B15715.0
16.0	170	52	13.0	120	3	12.5	B15716.0
17.0	175	54	13.5	123	3	14.0	B15717.0
18.0	182	56	14.0	130	3	14.0	B15718.0
19.0	189	58	14.5	131	3	16.0	B15719.0
20.0	195	60	15.0	137	3	16.0	B15720.0

B161



- 机用铰刀
- Alargador Máquina
- Escariador de máquina
- Machine Reamer

B161

B161	▪	1.1	1.2	1.3	1.4	2.1	4.1	5.1											
	•	1.5	1.6	2.2	2.3	3.1	3.2	3.3	3.4	4.2	4.3	5.2	5.3	6.1	6.2	6.3	6.4		



d_1 Ø mm	l_1 mm	l_2 mm	l_3 mm	z	MK	B161
3.0	113	15	47.5	6	1	B1613.0
4.0	124	19	58.5	6	1	B1614.0
5.0	133	23	67.5	6	1	B1615.0
6.0	138	26	72.5	6	1	B1616.0
7.0	150	31	84.5	6	1	B1617.0
8.0	156	33	90.5	6	1	B1618.0
9.0	162	36	96.5	6	1	B1619.0
10.0	168	38	102.5	6	1	B16110.0
11.0	175	41	109.5	6	1	B16111.0
12.0	182	44	116.5	6	1	B16112.0
13.0	182	44	116.5	6	1	B16113.0
14.0	189	47	123.5	8	1	B16114.0
15.0	204	50	124	8	2	B16115.0
16.0	210	52	130	8	2	B16116.0
17.0	214	54	134	8	2	B16117.0
18.0	219	56	139	8	2	B16118.0
19.0	223	58	143	8	2	B16119.0
20.0	228	60	148	8	2	B16120.0
21.0	232	62	152	8	2	B16121.0
22.0	237	64	157	8	2	B16122.0
23.0	241	66	161	8	2	B16123.0
24.0	268	68	169	8	3	B16124.0
25.0	268	68	169	8	3	B16125.0
26.0	273	70	174	8	3	B16126.0
27.0	277	71	178	10	3	B16127.0
28.0	277	71	178	10	3	B16128.0
29.0	281	73	182	10	3	B16129.0
30.0	281	73	182	10	3	B16130.0
31.0	285	75	186	10	3	B16131.0
32.0	317	77	193	10	4	B16132.0
33.0	317	77	193	10	4	B16133.0
34.0	321	78	197	10	4	B16134.0
35.0	321	78	197	10	4	B16135.0
36.0	325	79	201	10	4	B16136.0
38.0	329	81	205	10	4	B16138.0
40.0	329	81	205	10	4	B16140.0

d_1 Ø	l_1	l_2	l_3	z	MK	B161
mm	mm	mm	mm			
42.0	333	82	209	12	4	B16142.0
44.0	336	83	212	12	4	B16144.0
45.0	336	83	212	12	4	B16145.0
46.0	340	84	216	12	4	B16146.0
47.0	340	84	216	12	4	B16147.0
48.0	344	86	220	12	4	B16148.0
50.0	344	86	220	12	4	B16150.0

B101



- 机用铰刀
- Alargador Máquina
- Escariador de máquina
- Machine Reamer

B101

B101	▪	1.1	1.2	1.3	1.4	2.1	3.1	4.1	6.2								
	•	1.5	1.6	3.2	3.3	3.4	4.2	4.3	5.1	5.2	5.3	6.1	6.3	6.4	7.1	7.2	8.2



d_1 Ø Inch	d_1 Ø mm	l_1 mm	l_2 mm	z	MK	B101
	3.00	112	33	4	1	B1013.0
1/8	3.18	112	33	4	1	B1011/8
	3.50	115	35	6	1	B1013.5
	4.00	117	38	6	1	B1014.0
	4.50	120	41	6	1	B1014.5
3/16	4.76	124	44	6	1	B1013/16
	5.00	124	44	6	1	B1015.0
	5.50	127	47	6	1	B1015.5
	6.00	127	47	6	1	B1016.0
1/4	6.35	130	50	6	1	B1011/4
	6.50	130	50	6	1	B1016.5
	7.00	134	54	6	1	B1017.0
5/16	7.94	138	58	6	1	B1015/16
	8.00	138	58	6	1	B1018.0
	8.50	138	58	6	1	B1018.5
	9.00	142	62	6	1	B1019.0
	9.50	142	62	6	1	B1019.5
3/8	9.52	146	66	6	1	B1013/8
	10.00	146	66	6	1	B10110.0
	10.50	146	66	6	1	B10110.5
	11.00	151	71	6	1	B10111.0
7/16	11.11	151	71	6	1	B1017/16
	12.00	156	76	6	1	B10112.0
	12.50	156	76	6	1	B10112.5
1/2	12.70	156	76	6	1	B1011/2
	13.00	156	76	6	1	B10113.0
	13.50	161	81	6	1	B10113.5
	14.00	161	81	8	1	B10114.0
9/16	14.29	181	81	8	2	B1019/16
	14.50	181	81	8	2	B10114.5
	15.00	181	81	8	2	B10115.0
	15.50	187	87	8	2	B10115.5
5/8	15.88	187	87	8	2	B1015/8
	16.00	187	87	8	2	B10116.0
	16.50	187	87	8	2	B10116.5
	17.00	187	87	8	2	B10117.0
	18.00	193	93	8	2	B10118.0
	19.00	193	93	8	2	B10119.0

d₁ Ø	d₁ Ø	l₁	l₂	z	MK	B101
Inch	mm	mm	mm			
3/4	19.05	200	100	8	2	B1013/4
	20.00	200	100	8	2	B10120.0
13/16	20.64	200	100	8	2	B10113/16
	21.00	200	100	8	2	B10121.0
7/8	22.00	207	107	8	2	B10122.0
	22.22	207	107	8	2	B1017/8
	23.00	207	107	8	2	B10123.0
	24.00	242	115	8	3	B10124.0
	25.00	242	115	10	3	B10125.0
1"	25.40	242	115	10	3	B1011
	26.00	242	115	10	3	B10126.0
	27.00	251	124	10	3	B10127.0
	28.00	251	124	10	3	B10128.0
1.1/8	28.58	251	124	10	3	B1011.1/8
	29.00	251	124	10	3	B10129.0
	30.00	251	124	10	3	B10130.0
1.1/4	31.00	260	133	10	3	B10131.0
	31.75	260	133	10	3	B1011.1/4
	32.00	293	133	10	4	B10132.0
	34.00	302	142	10	4	B10134.0
1.3/8	34.93	302	142	10	4	B1011.3/8
	35.00	302	142	10	4	B10135.0
	36.00	302	142	10	4	B10136.0
	37.00	302	142	10	4	B10137.0
	38.00	312	152	10	4	B10138.0
1.1/2	38.10	312	152	10	4	B1011.1/2
	39.00	312	152	10	4	B10139.0
	40.00	312	152	10	4	B10140.0
	41.00	312	152	10	4	B10141.0
	42.00	312	152	10	4	B10142.0
	43.00	323	163	10	4	B10143.0
1.3/4	44.00	323	163	10	4	B10144.0
	44.45	323	163	10	4	B1011.3/4
	45.00	323	163	12	4	B10145.0
	46.00	323	163	12	4	B10146.0
	47.00	323	163	12	4	B10147.0
2"	48.00	334	174	12	4	B10148.0
	50.00	334	174	12	4	B10150.0
	50.80	334	174	12	4	B1012

B121

HSS



DIN
311



k11



- 莫氏锥柄扩孔铰刀
- Alargador Cônico com Haste Cônica
- MTS Escariador de mango cônico
- Morse Taper Shank Bridge Reamer

起始锥度 (I3) 为 1:10
Com 1:10 de conicidade inicial
Incluido cónico 1:10
With 1:10 starting taper (I3)

B121

B121

▪	1.1	1.2	1.3	1.4	3.1	4.1
•	1.5	1.6	3.2	3.3	3.4	8.2



B121



10.00 - 30.00

d_1 Ø	l_1	l_2	l_3	z	MK	B121
10.0	171	95	30	4	1	B12110.0
11.0	176	100	33	4	1	B12111.0
12.0	199	105	39	4	2	B12112.0
13.0	199	105	39	4	2	B12113.0
14.0	209	115	42	4	2	B12114.0
15.0	219	125	45	4	2	B12115.0
16.0	229	135	48	4	2	B12116.0
17.0	251	135	51	4	3	B12117.0
18.0	261	145	58	4	3	B12118.0
19.0	261	145	58	4	3	B12119.0
20.0	271	155	62	4	3	B12120.0
21.0	271	155	62	4	3	B12121.0
22.0	281	165	66	4	3	B12122.0
23.0	281	165	66	4	3	B12123.0
24.0	296	180	72	4	3	B12124.0
25.0	296	180	72	4	3	B12125.0
26.0	296	180	72	4	3	B12126.0
30.0	311	195	78	5	3	B12130.0

B954



- 45 度左螺旋圆锥销机用铰刀
- Alargador Máquina para pinos Cônicos com corte a esquerda - Hélice 45°
- Escariador de máquina para pasadores cónicos Hélice a izquierdas 45°
- Machine Reamer for Conical Pin Left Hand Helix 45°

B954

B954	▪	2.1	2.2	2.3	4.1	4.2	4.3	5.1	5.2	5.3	6.1	7.1	7.2	7.3	7.4	8.1
	•	1.1	1.2	1.3	1.4	1.5	1.6	6.2	9.1							



nom Ø	d ₁ Ø mm	d ₂ Ø mm	l ₁ mm	l ₂ mm	z	MK	B954
5.0	4.90	6.36	155	73	3	1	B9545.0
6.0	5.90	8.00	187	105	3	1	B9546.0
8.0	7.90	10.80	227	145	3	1	B9548.0
10.0	9.90	13.40	257	175	3	1	B95410.0
12.0	11.80	16.00	315	210	3	2	B95412.0
13.0	12.86	16.74	295	194	3	2	B95413.0
14.0	13.86	17.74	295	194	3	2	B95414.0
16.0	15.80	20.40	335	230	3	2	B95416.0
20.0	19.80	24.80	377	250	3	3	B95420.0
25.0	24.70	30.70	427	300	3	3	B95425.0
30.0	29.70	36.10	475	320	4	4	B95430.0

B955

HSS-E



DIN
219



B

H7



- 套式铰刀
- Cabeça Intercambiável de Alargador Caracol
- Escariador hueco
- Shell Reamer

d2 = B956 的标称直径 d1
 d2=Diâmetro nominal d1 do B956
 d2=Diâmetro nominal d1 de B956
 d2=Nominal diameter d1of B956

B955

B955	▪	1.1	1.2	1.3	1.4	2.1	4.1	5.1										
	•	1.5	1.6	2.2	2.3	3.1	4.2	4.3	5.2	5.3	6.1	6.2	7.1	7.2	7.3	7.4	8.2	

B955



25.00 - 80.00

d ₁ Ø	l ₁	l ₂	z	d ₂ Ø	B955
mm	mm	mm		mm	
25.0	45	32	8	13	B95525.0
26.0	45	32	8	13	B95526.0
27.0	45	32	8	13	B95527.0
28.0	45	32	8	13	B95528.0
29.0	45	32	8	13	B95529.0
30.0	45	32	8	13	B95530.0
31.0	50	36	10	16	B95531.0
32.0	50	36	10	16	B95532.0
34.0	50	36	10	16	B95534.0
35.0	50	36	10	16	B95535.0
36.0	56	40	10	19	B95536.0
37.0	56	40	10	19	B95537.0
38.0	56	40	10	19	B95538.0
40.0	56	40	10	19	B95540.0
42.0	56	40	10	19	B95542.0
44.0	63	45	12	22	B95544.0
45.0	63	45	12	22	B95545.0
48.0	63	45	12	22	B95548.0
50.0	63	45	12	22	B95550.0
52.0	71	50	12	27	B95552.0
55.0	71	50	12	27	B95555.0
58.0	71	50	12	27	B95558.0
60.0	71	50	12	27	B95560.0
65.0	80	56	14	32	B95565.0
70.0	80	56	14	32	B95570.0
75.0	90	63	14	40	B95575.0
80.0	90	63	14	40	B95580.0

B956

HSS-E



DIN
217



B956

- 莫氏锥柄铰刀刀杆 (B955)
- Haste Cônica Alargador Caracol (B955)
- Mango cónico Portaescariadores para escariadores huecos
- Morse Taper Shank Shell Reamer Arbor (B955)



13.00 - 40.00

d_1 Ø mm	l_1 mm	l_2 mm	l_3 mm	MK	B956
13.0	250	45	151	3	B95613.0
16.0	261	50	162	3	B95616.0
19.0	298	56	174	4	B95619.0
22.0	312	63	188	4	B95622.0
27.0	359	71	203	5	B95627.0
32.0	376	80	220	5	B95632.0
40.0	396	90	240	5	B95640.0

B957

- 套式铰刀心轴配件 (B956)
- Alargador Caracol - Acessório (B956)
- Portaescariadores para escariadores huecos - Accesorios (B956)
- Shell Reamer Arbor - Spare Parts (B956)



DRIVER



NUT



WASHER



Nr.	d	B957
3	13.00	B957N3DRIVER
3		B957N3NUT
3		B957N3WASHER
4	16.00	B957N4DRIVER
4		B957N4NUT
4		B957N4WASHER
5	19.00	B957N5DRIVER
5		B957N5NUT
5		B957N5WASHER
6	22.00	B957N6DRIVER
6		B957N6NUT
6		B957N6WASHER
7	27.00	B957N7DRIVER
7		B957N7NUT
7		B957N7WASHER
8	32.00	B957N8DRIVER
8		B957N8NUT
8		B957N8WASHER
9	40.00	B957N9DRIVER
9		B957N9NUT
9		B957N9WASHER

G400



G400

- 高精度 - 90° 铤钻
- Escareador para chanfrar - 90°
- Avellanadores para portas de alta precisión - 90°
- Countersink for High Precision Chucks - 90°

G400	■	1.1	1.2	1.3	1.4	1.5	4.1	4.2	4.3	5.1	5.2	5.3	6.1	6.2	6.3
	•	1.6	2.1	2.2	2.3	3.1	3.2	3.3	3.4	6.4	7.1	7.2	7.3	7.4	8.1



max d mm	min d mm	l ₁ mm	d ₂ Øh ₅ mm	z	G400
6.30	1.5	45	5	3	G4006.3
8.30	2.0	50	6	3	G4008.3
10.40	2.5	50	6	3	G40010.4
12.40	2.8	56	8	3	G40012.4
16.50	3.2	60	10	3	G40016.5
20.50	3.5	63	10	3	G40020.5
25.00	3.8	67	10	3	G40025.0
31.00	4.2	71	12	3	G40031.0

G405



- 镗钻双端 - 90°
- Escareador duas pontas - 90°
- Avellanadores, Doble punta - 90°
- Countersink Double Ended - 90°

G405

G405	■	1.1	1.2	1.3	1.4	1.5	4.1	4.2	4.3	5.1	5.2	5.3	6.1	6.2	6.3
	•	1.6	2.1	2.2	2.3	3.1	3.2	3.3	3.4	6.4	7.1	7.2	7.3	7.4	8.1

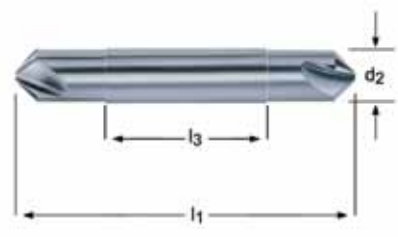

max d	min d	l ₁	l ₃	d ₂	z	G405
mm	mm	mm	mm	∅h ₆ mm		
8.30	2.0	67	46	10	3	G4058.3
10.40	2.5	74	47	12	3	G40510.4
12.40	2.8	76	45	14	3	G40512.4

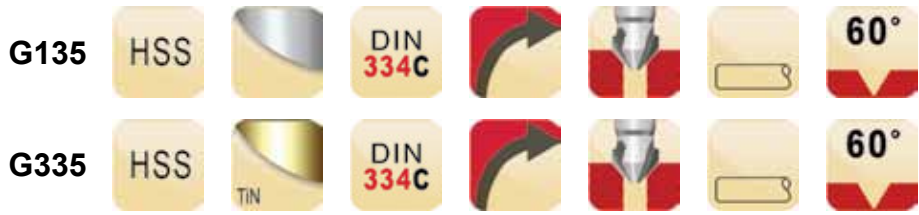

- G135**
- 铤钻 - 60°
 - Escareador - 60°
- G335**
- Avellanadores - 60°
 - Countersink - 60°

G135	▪	1.1	1.2	1.3	1.4	1.5	4.1	4.2	4.3	5.1	5.2	5.3	6.1	6.2	6.3
	•	1.6	2.1	2.2	2.3	3.1	3.2	3.3	3.4	6.4	7.1	7.2	7.3	7.4	8.1
G335	▪	1.1	1.2	1.3	3.1	3.2	3.3	3.4	7.1	7.2	7.3	7.4			
	•	1.4	1.5	1.6	4.1	4.2	4.3	5.1	5.2	5.3	6.1	6.2	6.3	6.4	8.1



max d mm	min d mm	l_1 mm	d_2 $\varnothing h_9$ mm	z	G135	G335
6.3	1.6	45	5	3	G1356.3	G3356.3
8.0	2.0	50	6	3	G1358.0	G3358.0
10.0	2.5	50	6	3	G13510.0	G33510.0
12.5	3.2	56	8	3	G13512.5	G33512.5
16.0	4.0	63	10	3	G13516.0	G33516.0
20.0	5.0	67	10	3	G13520.0	G33520.0
25.0	6.3	71	10	3	G13525.0	G33525.0

G137



- 莫氏锥柄铤钻 - 60°
- Escareador de Haste Cônica - 60°
- Avellanadores de mango cónico - 60°
- Morse Taper Shank Countersink - 60°

G137

G137	■	1.1	1.2	1.3	1.4	1.5	4.1	4.2	4.3	5.1	5.2	5.3	6.1	6.2	6.3
	•	1.6	2.1	2.2	2.3	3.1	3.2	3.3	3.4	6.4	7.1	7.2	7.3	7.4	8.1



max d mm	min d mm	l ₁ mm	MK	z	G137
16.0	4.0	90	1	3	G13716.0
20.0	5.0	106	2	3	G13720.0
25.0	6.3	112	2	3	G13725.0
31.5	10.0	118	2	3	G13731.5
40.0	12.5	150	3	3	G13740.0
50.0	16.0	160	3	3	G13750.0
63.0	20.0	190	4	3	G13763.0
80.0	25.0	200	4	3	G13780.0

G154



G154

- 铤钻 - 82°
- Escareador - 82°
- Avellanadores - 82°
- Countersink - 82°

G154	▪	1.1	1.2	1.3	1.4	1.5	4.1	4.2	4.3	5.1	5.2	5.3	6.1	6.2	6.3
	•	1.6	2.1	2.2	2.3	3.1	3.2	3.3	3.4	6.4	7.1	7.2	7.3	7.4	8.1



max d mm	min d mm	l_1 mm	d_2 $\varnothing h_9$ mm	z	G154
6.3	1.5	45	5	3	G1546.3
8.3	2.0	50	6	3	G1548.3
10.4	2.5	50	6	3	G15410.4
12.4	2.8	56	8	3	G15412.4
16.5	3.2	60	10	3	G15416.5
20.5	3.5	63	10	3	G15420.5
25.0	3.8	67	10	3	G15425.0

G129



- 铤钻 - 90°
- Escareador - 90°
- Avellanadores - 90°
- Countersink - 90°

G129

G129	▪	1.1	1.2	1.3	1.4	4.1	4.2	5.1	5.2	6.1	6.2	6.3	7.1	7.2	
	•	1.5	1.6	2.1	2.2	3.1	3.2	3.3	3.4	4.3	5.3	6.4	7.3	7.4	8.1



max d mm	l ₁ mm	d ₂ Øh ₃ mm	z	G129
6.00	45	6	1	G1296.0
8.00	50	8	1	G1298.0
10.00	49	8	1	G12910.0
12.50	49	8	1	G12912.5
16.00	56	10	1	G12916.0
20.00	60	10	1	G12920.0
25.00	75	12	1	G12925.0
31.50	80	12	1	G12931.5

G149



G149

- 铤钻 - 90°
- Escareador - 90°
- Avellanadores - 90°
- Countersink - 90°

G149	▪	1.1	1.2	1.3	1.4	4.1	4.2	5.1	5.2	6.1	6.2	6.3	7.1	7.2		
	•	1.5	1.6	2.1	2.2	3.1	3.2	3.3	3.4	4.3	5.3	6.4	7.3	7.4	8.1	8.2



max d mm	min d mm	l_1 mm	d_2 Ø mm	d_1 Ø mm	z	G149
5	2	45	6	10	1	G1495
10	5	48	8	14	1	G14910
15	10	65	10	21	1	G14915
20	15	84	12	28	1	G14920
25	20	102	15	35	1	G14925
30	25	115	15	44	1	G14930
35	30	127	15	48	1	G14935
40	35	136	15	53	1	G14940
50	40	166	20	60	1	G14950



G136

- 铤钻 - 90°
- Escareador - 90°

G560

- Avellanadores - 90°
- Countersink - 90°

G142

- 铤钻 - 90°
- Escareador com Alívio Radial Extra - 90°
- Avellanadores com alívio radial extra - 90°
- Countersink with extra radial relief - 90°

G570

- 铤钻 - 90°
- Escareador - 90°
- Avellanadores - 90°
- Countersink - 90°

G136	▪	1.1	1.2	1.3	1.4	4.1	4.2	5.1	5.2	6.1	6.2	6.3	7.1	7.2	8.1				
	•	1.5	1.6	2.1	2.2	2.3	3.1	3.2	3.3	3.4	4.3	5.3	6.4	7.3	7.4	8.2			
G560	▪	1.1	1.2	1.3	1.4	1.5	2.1	3.1	3.2	3.3	3.4	5.1	5.2	5.3	7.3	7.4			
	•	1.6	2.2	2.3	4.1	4.2	4.3	6.1	6.2	6.3	6.4	7.1	7.2	8.1	8.2				
G142	▪	1.1	1.2	2.1	2.2	2.3	4.1	5.1	6.1	6.2	7.1	7.2	8.1	8.2					
	•	1.3	1.4	4.2	5.2	6.3	7.3	7.4											
G570	▪	1.4	1.5	2.1	2.2	2.3													
	•	1.1	1.2	1.3	1.6	2.4	3.1	3.2	3.3	3.4	5.2	5.3	6.1	6.2	6.3	6.4	7.1	7.2	7.3

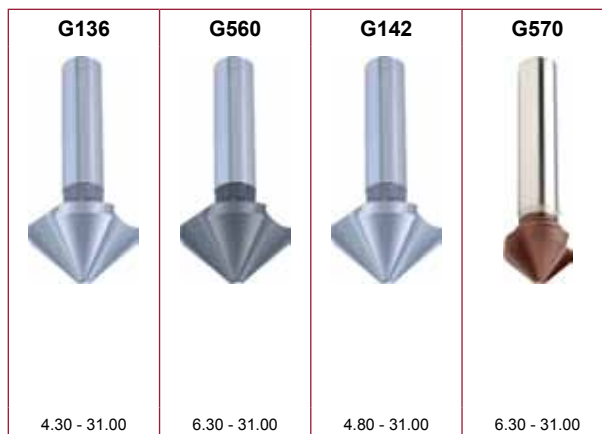

max d	min d	l ₁	d ₂	z	G136	G560	G142	G570
mm	mm	mm	Øh ₉ mm					
4.3	1.3	40	4	3	G1364.3			
4.8	1.3	40	4	3			G1424.8	
5.0	1.5	40	4	3	G1365.0		G1425.0	
5.3	1.5	40	4	3	G1365.3			

max d mm	min d mm	l ₁ mm	d ₂ Øh ₉ mm	z	G136	G560	G142	G570
5.8	1.5	45	5	3	G1365.8			
6.0	1.5	45	5	3	G1366.0		G1426.0	
6.3	1.5	45	5	3	G1366.3	G5606.3	G1426.3	G5706.3
7.0	1.8	50	6	3	G1367.0		G1427.0	
7.3	1.8	50	6	3	G1367.3		G1427.3	
8.0	2.0	50	6	3	G1368.0	G5608.0	G1428.0	
8.3	2.0	50	6	3	G1368.3	G5608.3	G1428.3	G5708.3
9.4	2.2	50	6	3	G1369.4			
10.0	2.5	50	6	3	G13610.0	G56010.0	G14210.0	
10.4	2.5	50	6	3	G13610.4	G56010.4	G14210.4	G57010.4
11.5	2.8	56	8	3	G13611.5		G14211.5	
12.4	2.8	56	8	3	G13612.4	G56012.4	G14212.4	G57012.4
13.4	2.9	56	8	3	G13613.4			
15.0	3.2	60	10	3	G13615.0		G14215.0	
16.5	3.2	60	10	3	G13616.5	G56016.5	G14216.5	G57016.5
19.0	3.5	63	10	3	G13619.0		G14219.0	
20.5	3.5	63	10	3	G13620.5	G56020.5	G14220.5	G57020.5
23.0	3.8	67	10	3	G13623.0		G14223.0	
25.0	3.8	67	10	3	G13625.0	G56025.0	G14225.0	G57025.0
26.0	3.8	67	10	3	G13626.0			
28.0	4.0	71	12	3	G13628.0			
30.0	4.2	71	12	3	G13630.0			
31.0	4.2	71	12	3	G13631.0	G56031.0	G14231.0	G57031.0

G600



- 镗钻，超长 - 90°
- Escareador Extra Longo - 90°
- Avellanadores, extra larga - 90°
- Countersink, Extra Long - 90°

G600

G600	■	1.1	1.2	1.3	1.4	1.5										
	•	1.6	2.1	2.2	2.3	3.1	3.2	3.3	6.1	6.2	6.3	6.4	7.1	7.2	7.3	7.4

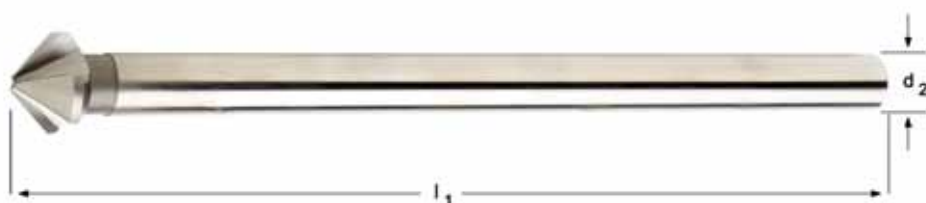

max d mm	min d mm	l_1 mm	d_2 $\varnothing h_9$ mm	z	G600
6.3	1.3	154	5	3	G6006.3
8.3	1.8	155	6	3	G6008.3
10.4	2.2	157	6	3	G60010.4
12.4	2.5	158	8	3	G60012.4
15.0	2.8	159	10	3	G60015.0
16.5	2.8	161	10	3	G60016.5
20.5	3.0	164	10	3	G60020.5
25.0	3.2	168	10	3	G60025.0

G132



G132

- 铤钻 - 90°
- Escareador - 90°
- Avellanadores - 90°
- Countersink - 90°

G132	▪	1.5	1.6	3.4	4.2	4.3	5.2	5.3	6.4
	•	1.3	1.4	2.3	8.3				



max d mm	min d mm	l_1 mm	d_2 $\varnothing h_9$ mm	z	G132
8.0	-	48	8	5	G1328.0
12.5	2.0	48	8	5	G13212.5
16.0	3.2	56	10	7	G13216.0
20.0	5.0	60	10	7	G13220.0

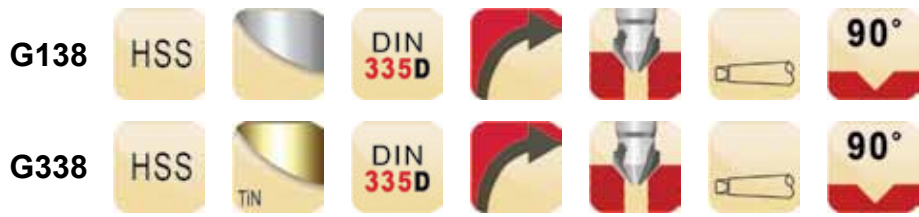

- G138**
- 莫氏锥柄铤钻 - 90°
 - Escareador de Haste Cônica - 90°
- G338**
- Avellanadores de mango cónico - 90°
 - Morse Taper Shank Countersink - 90°

G138	▪	1.1	1.2	1.3	1.4	1.5	4.1	4.2	4.3	5.1	5.2	5.3	6.1	6.2	6.3
	•	1.6	2.1	2.2	2.3	3.1	3.2	3.3	3.4	6.4	7.1	7.2	7.3	7.4	8.1
G338	▪	1.1	1.2	1.3	1.4	1.5	3.1	3.2	3.3	3.4	7.1	7.2	7.3	7.4	
	•	1.6	4.1	4.2	4.3	5.1	5.2	5.3	6.1	6.2	6.3	6.4	8.1	8.2	



max d mm	min d mm	L ₁ mm	MK	z	G138	G338
25.0	3.8	106	2	3	G13825.0	G33825.0
30.0	4.2	112	2	3	G13830.0	
31.0	4.2	112	2	3	G13831.0	G33831.0
34.0	4.5	118	2	3	G13834.0	
37.0	4.8	118	2	3	G13837.0	G33837.0
40.0	10.0	140	3	3	G13840.0	G33840.0
50.0	14.0	150	3	3	G13850.0	G33850.0
63.0	16.0	180	4	3	G13863.0	G33863.0
80.0	22.0	190	4	3	G13880.0	

G171



G171

- 铤钻 - 100°
- Escareador - 100°
- Avellanadores - 100°
- Countersink - 100°

G171	▪	1.1	1.2	1.3	3.1	3.2	3.3	3.4	7.1	7.2	7.3	7.4			
	•	1.4	1.5	1.6	4.1	4.2	4.3	5.1	5.2	5.3	6.1	6.2	6.3	6.4	8.1

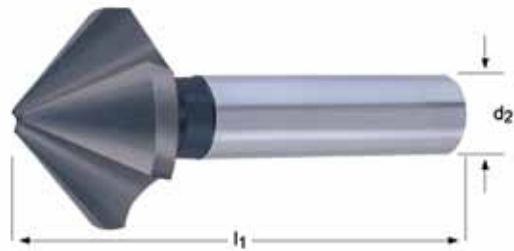

max d mm	min d mm	l_1 mm	d_2 $\varnothing h_3$ mm	z	G171
6.3	1.5	44.0	5.0	3	G1716.3
8.3	2.0	49.0	6.0	3	G1718.3
10.4	2.5	49.0	6.0	3	G17110.4
12.4	2.8	53.0	6.0	3	G17112.4
16.5	3.2	56.0	6.0	3	G17116.5
20.5	3.5	61.0	10.0	3	G17120.5
25.0	3.8	65.0	10.0	3	G17125.0

M138



- 圆锥钻
- Broca Cônica
- Broca Multi-diámetro
- Conical Drill

M138

M138	▪	1.1	1.2	1.3	1.4	4.1	4.2	4.3	5.1	5.2	5.3	6.1	6.2	6.3	7.1	7.2	8.1	8.2
	•	1.5	1.6	2.1	2.2	2.3	3.1	3.2	3.3	3.4	6.4	7.3	7.4					



Nr.	max d mm	min d mm	l ₂ mm	l ₁ mm	d ₂ h11 mm	M138
1	14	3	36	58	6	M1381
2	20	8	40	62	8	M1382
3	30	16	48	70	10	M1383
4	40	26	51	76	10	M1384
5	50	36	54	79	10	M1385
6	60	46	57	82	13	M1386

G314



G314

- 圆锥钻
- Broca Cônica
- Broca Multi-diámetro
- Conical Drill

G314	▪	1.1	1.2	1.3	1.4	4.1	4.2	4.3	5.1	5.2	5.3	6.1	6.2	6.3	7.1	7.2	8.1	8.2
	•	1.5	1.6	2.1	2.2	2.3	3.1	3.2	3.3	3.4	6.4	7.3	7.4					



Nr.	d min-max mm	l ₃ mm	l ₁ mm	d ₃ Ø mm	G314
412	4.0 mm ÷ 12.0 mm x 1.0 mm	5.0	80	6.0	G314412
1220	12.0 mm ÷ 20.0 mm x 1.0 mm	4.0	76	9.0	G3141220
2030	20.0 mm ÷ 30.0 mm x 1.0 mm	4.0	88	12.0	G3142030
3040	30.0 mm ÷ 40.0 mm x 1.0 mm	4.0	98	13.0	G3143040
420	4.0 mm ÷ 20.0 mm x 2.0 mm	4.0	76	8.0	G314420
630	6.0 mm ÷ 30.0 mm x 2.0 mm	4.0	98	10.0	G314630
M	9.0 mm ÷ 36.0 mm x 3.0 mm	3.0	86	12.0	G314M

G125



- 铤孔 - 180°
- Escareador - 180°
- Referantadores - 180°
- Counterbore - 180°

G125

G125	■	1.1	1.2	1.3	2.1	3.1	3.2	7.1	7.2	8.1								
	•	1.4	1.5	1.6	2.2	3.3	3.4	4.1	4.2	4.3	5.1	5.2	5.3	6.1	6.2	6.3	7.3	7.4



d_1 \varnothing_{z_3} mm	d_3 \varnothing_{e_8} mm	M	l_1 mm	l_2 mm	d_2 \varnothing_{h_3} mm	z	G125
6.5	2.5	M 3 t	71	14	5.0	3	G1256.5X2.5 ¹⁾
6.5	3.2	M 3 f	71	14	5.0	3	G1256.5X3.2 ²⁾
6.5	3.4	M 3 m	71	14	5.0	3	G1256.5X3.4 ³⁾
8.0	3.3	M 4 t	71	14	5.0	3	G1258.0X3.3 ¹⁾
8.0	4.3	M 4 f	71	14	5.0	3	G1258.0X4.3 ²⁾
8.0	4.5	M 4 m	71	14	5.0	3	G1258.0X4.5 ³⁾
10.0	4.2	M 5 t	80	18	8.0	3	G12510.0X4.2 ¹⁾
10.0	5.3	M 5 f	80	18	8.0	3	G12510.0X5.3 ²⁾
10.0	5.5	M 5 m	80	18	8.0	3	G12510.0X5.5 ³⁾
11.0	5.0	M 6 t	80	18	8.0	3	G12511.0X5.0 ¹⁾
11.0	6.4	M 6 f	80	18	8.0	3	G12511.0X6.4 ²⁾
11.0	6.6	M 6 m	80	18	8.0	3	G12511.0X6.6 ³⁾
15.0	6.8	M 8 t	100	22	12.5	3	G12515.0X6.8 ¹⁾
15.0	8.4	M 8 f	100	22	12.5	3	G12515.0X8.4 ²⁾
15.0	9.0	M 8 m	100	22	12.5	3	G12515.0X9.0 ³⁾
18.0	8.5	M 10 t	100	22	12.5	3	G12518.0X8.5 ¹⁾
18.0	10.5	M 10 f	100	22	12.5	3	G12518.0X10.5 ²⁾
18.0	11.0	M 10 m	100	22	12.5	3	G12518.0X11.0 ³⁾
20.0	10.2	M 12 t	100	22	12.5	3	G12520.0X10.2 ¹⁾
20.0	13.0	M 12 f	100	22	12.5	3	G12520.0X13.0 ²⁾
20.0	13.5	M 12 m	100	22	12.5	3	G12520.0X13.5 ³⁾

¹⁾ t = 用于攻丝底孔 / t = para furo do macho / t = Para agujero roscado / t = for tap hole
²⁾ f = 用于通孔的精加工 / f = furo passante fino / f = para agujero pasante fino / f = for through hole fine
³⁾ m = 用于通孔的半精加工 / m = para furo passante médio / m = Para agujero pasante medio / m = for through hole medium

G236

- 套装铤钻
- Jogo de escareadores
- Juego de Avellanadores
- Countersink set

A=套件中的型号, B=套件中的数量, C=套件中的直径
 A=Tipos no jogo, B=No. no jogo, C=Diâmetros no jogo
 A=Tipos en el juego, B=No. en el Juego, C=Diámetros en el Juego
 A=Styles in Set, B=No. in Set, C=Diameters in Set



Nr.	A	B	C	G236
1	G136	6	6.30 mm, 8.30 mm, 10.40 mm, 12.40 mm, 16.50 mm, 20.50 mm	G2361
2	G136	4	6.30 mm, 10.40 mm, 16.50 mm, 20.50 mm	G2362
3	G560	6	6.30 mm, 8.30 mm, 10.40 mm, 12.40 mm, 16.50 mm, 20.50 mm	G2363

E000	216	E250	201	E501	204	EP006G	210
E000TIN	216	E251	201	E504	204	EP006H	210
E001	216	E252	203	E510	217	EP00TIN	210
E002	229	E255	213	E513	239	EP016H	210
E002TIN	229	E256	213	E515	255	EP10	243
E003	229	E258	221	E524	264	EP10TIN	243
E011	247	E260	226	E531	273	EP11	243
E013	252	E261	226	E533	276	EP20	257
E021	258	E263	221	E534	275	EP21	257
E023	260	E266	219	E536	277	EP30	266



187 - 312



E031	267	E268	237	E538	279	EP31	266
E033	269	E275	254	E539	278	EP40	286
E041	287	E278	263	E542	280	EP41	286
E043	290	E282	284	E544	282	EX006G	224
E052	223	E290	237	E545	281	EX006H	224
E100	199	E291	232	E547	285	EX00TIN	224
E101	199	E292	232	E550	293	EX016H	224
E102	199	E293	232	E570	271	EX10	248
E105	234	E294	232	E600	209	EX10TIN	248
E108	253	E295	233	E605	231	EX11	248
E111	262	E296	233	E606	218	EX20	259
E115	272	E297	212	E610	209	EX21	259
E119	283	E298	225	E620	291	EX30	268
E200	201	E299	245	E621	292	EX31	268
E201	203	E300	250	E650	230	EX40	288
E207	221	E303	208	E651	261	EX41	288
E212	221	E382	289	E653	297	L110	302
E216	219	E383	251	E654	270	L111	303
E225	254	E384	246	E708	300	L113	306
E229	263	E390	203	E709	299	L114	307
E237	201	E422	219	E710	295	L115	308
E238	227	E423	219	E711	296	L119	304
E239	227	E471	215	E712	298	L120	309
E240	214	E472	215	E714	294	L126	305
E241	214	E473	228	E720	299		
E242	237	E474	228	E721	295		
E243	301	E500	204				

螺纹形式	Tipo de Rosca	Forma de Rosca	Thread form
标准	Norma	Estándar	Standard
公差	Tolerância	Tolerancia	Tolerance
孔型	Tipo do furo	Tipo de agujero	Hole Type
深度	Profundidade	Profundidad	Depth
材料	Material	Material	Material
倒锥	Chanfro	Chaflán	Chamfer
槽型	Geometria	Geometría	Flute geometry
加工方向	Direção	Dirección	Direction
涂层	Tratamento	Tratamiento superficial	Coating
■ 性能卓越	Excelente para a Aplicação	Excelente para Aplicación	Excellent for Application
■ 性能良好	Bom para a Aplicação	Bueno para Aplicación	Good for Application
实例 10 = 外缘处的切削速度，米/分， +/- 10%	Exemplo 10 = Velocidade periférica em metros/minuto +/- 10%	Ejemplo 10 = Velocidad Periférica en metros/ minuto +/- 10%	Example 10 = Peripheral speed in metres/minute +/- 10%
产品型号	Código	Código de producto	Product Codes
尺寸范围	Gama de medidas	Rango de Diámetros	Size Range

AMG	中文	Português	Español	English
1.1	铁磁性低碳钢	Aço macio magnético	Acero blando	Magnetic soft steel
1.2	结构钢, 表面渗碳钢	Aço estrutural, Aço cementado	Acero de construcción/cementación	Structural steel, case carburizing steel
1.3	普通碳钢	Aço-carbono	Acero al carbono	Plain Carbon steel
1.4	合金钢	Aço de liga	Acero aleado	Alloy steel
1.5	合金钢, 淬火回火钢	Aço de liga, Aço temperado	Acero aleado/temple y revenido	Alloy steel, Hardened and tempered steel
1.6	合金钢, 淬火回火钢	Aço de liga, Aço temperado	Acero aleado/temple y revenido	Alloy steel, Hardened and tempered steel
1.7	热处理合金钢	Aço de liga temperado	Acero aleado cementado	Alloy steel, Heat treated
1.8	淬火合金钢, 耐磨钢	Aço de liga temperado	Acero aleado cementado	Alloy steel, Hardened & Wear resistant steel
2.1	易切削不锈钢	Aço inoxidável de maquinação fácil	Acero inoxidable fácil mecanizado	Free machining, Stainless Steel
2.2	奥氏体不锈钢	Austenítico	Austenítico	Austenitic
2.3	铁素体 + 奥氏体, 马氏体不锈钢	Ferrítico + Austenítico + Martensítico	Ferrítico, Ferr. + Aust., Marten	Ferritic + Austenitic, Ferritic, Martensitic
2.4	沉淀硬化不锈钢	Aço inoxidável de fácil usinagem	Acero Inoxidable Templado	Precipitation Hardened
3.1	灰铸铁	Grafite laminar	Con grafito laminar	Lamellar graphite
3.2	灰铸铁	Grafite laminar	Con grafito laminar	Lamellar graphite
3.3	球墨铸铁, 可锻铸铁	Grafite nodular/ Ferro fundido maleável	Con graf. laminar, fundic. maleable	Nodular graphite, Malleable Cast Iron
3.4	球墨铸铁, 可锻铸铁	Grafite nodular/ Ferro fundido maleável	Con graf. laminar, fundic. maleable	Nodular graphite, Malleable Cast Iron
4.1	纯钛	Titânio, sem liga	Titanio no aleado	Titanium, unalloyed
4.2	钛合金	Titânio, com liga	Titanio aleado	Titanium, alloyed
4.3	钛合金	Titânio, com liga	Titanio aleado	Titanium, alloyed
5.1	纯镍	Níquel, sem liga	Níquel no aleado	Nickel, unalloyed
5.2	镍合金	Níquel, com liga	Níquel aleado	Nickel, alloyed
5.3	镍合金	Níquel, com liga	Níquel aleado	Nickel, alloyed
6.1	紫铜	Cobre	Cobre	Copper
6.2	β黄铜, 青铜	Latão beta, bronze	β-Latón, bronce	β-Brass, Bronze
6.3	α黄铜	Latão alfa	α-Latón	α-Brass
6.4	高强度青铜	Bronze de alta resistência	Metal AMPCO	High Strength Bronze
7.1	纯铝, 纯镁	Al, Mg, sem liga	Al, Mg, no aleado	Al, Mg, unalloyed
7.2	铝合金, 硅含量 < 0.5%	Al com liga, Si<0.5%	Al aleado con Si < 0.5%	Al alloyed, Si < 0.5%
7.3	铝合金, 硅含量 > 0.5% < 10%	Al com liga, Si>0.5%<10%	Al aleado con Si > 0.5% < 10%	Al alloyed, Si > 0.5% < 10%
7.4	铝合金, 硅含量 > 10% 晶须增强铝合金, 镁合金	Al com liga, Si>10% reforçadas com monocristais filiformes, ligas de Al/Mg	Al aleado, Si>10% Reforzado por filamentos, Al-aleados, Mg-aleados	Al alloyed, Si > 10% Whisker reinforced Al-alloys Mg-alloys
8.1	热塑性塑料	Termoplásticos	Termoplásticos	Thermoplastics
8.2	热固性塑料	Plásticos termoduros	Plásticos endurecidos por calor	Thermosetting plastics
8.3	增强塑料	Materiais plásticos reforçados	Materiales plásticos reforzados	Reinforced plastic materials
9.1	金属陶瓷	Cerametal (metalocerâmica)	Cermetales (metales-cerámicas)	Cermets (metals-ceramics)
10.1	标准石墨	Grafite standard	Grafito standard	Graphite

	M	M	M	M	M	M	M	M	M	M	M	M	M	M	M	M	M		
	DIN 352	DIN 352	DIN 352	DIN 371	DIN 376	DIN 371	DIN 376	DIN 371	DIN 376	DIN 376	DIN 376	DIN 376	DIN 376	DIN 376	DIN 376	DIN 376	DIN 376		
	6H	6HX	6H	6H	6H	6H	6H	6H	6HX	6HX	6HX	6H	6H	6H	6H	6H	6H		
	1.5XD	1.5XD	1.5XD	1.5XD	1.5XD	1.5XD	1.5XD	2XD	2XD	2XD	2XD	1.5XD	1.5XD	1.5XD	2XD	1.5XD	1.5XD	2.5XD	
	HSS	HSS-E	HSS	HSS-E	HSS-E	HSS-E	HSS-E	HSS-E	HSS-E	HSS-E	HSS-E	HSS	HSS	HSS	HSS-E	HSS-E	HSS-E	HSS-E	
	C 2-3	C 2-3	C 2-3	A 6-8 C 2-3	A 6-8 C 2-3	C 2-3	C 2-3	C 2-3	C 2-3	C 2-3	C 2-3				D18-20 C 2-3	C 2-3	C 2-3	B 3.5-5	
	E100	E102	E101	E200	E250	E237	E251	E201	E252	E390	E500	E501	E504	E303	E600	E610	EP006H		
	M1.6 - M52	M3 - M30	M4 - M16	M2 - M10	M3 - M52	M3 - M10	M12 - M24	M3 - M10	M8 - M24	M3 - M20	M1 - M56	M3 - M24	M3 - M24	M3 - M20	M3 - M30	M3 - M16	M2 - M30		
								NEW	NEW	NEW									
AMG	199	199	199	201	201	201	201	203	203	203	204	204	204	208	209	209	210	ISO	
1.1	1	1	1	12	12	12	12				7	7	14	12	7	14	25	P 1	
1.2	1	1	1	10	10	10	10				6	6	12	10	6	12	22	P 1	
1.3	1	1	1	8	8	8	8				5	5	10	8	5	10	18	P 2	
1.4	1	1	1	6	6	6	6				4	4	8	6	4	8	16	P 3	
1.5	1	1	1	5	5	5	5				3	3	6	5	3	6	10	P 4	
1.6																	5	H 1	
1.7																			H 3
1.8																			H 4
2.1		1																	M 1
2.2		1																	M 3
2.3		1																	M 2
2.4																			S 2
3.1	1	1	1	14	14	14	14	15	15	30	12	12	18	14	12	18	15		K 1
3.2	1	1	1	8	8	8	8	8	8	25	7	7	12	8	7	12	8		K 2
3.3	1	1	1	12	12	12	12	15	15	35	10	10	22	12	10	22	15		K 3
3.4	1	1	1					8	8	25	5	5	12		5	12	8		K 4
4.1		1															10		S 1
4.2		1															5		S 2
4.3		1																	S 3
5.1		1															12		S 1
5.2		1															5		S 2
5.3		1																	S 3
6.1	1	1	1								4	4			4		12		N 3
6.2	1	1	1	16	16	16	16	20	20	30	10	10	20	16	10	20	30		N 4
6.3	1	1	1	12	12	12	12				7	7	14	12	7	14	20		N 3
6.4	1	1	1					5	5	5	2	2	4		2	4			N 4
7.1																	16		N 1
7.2	1	1	1	20	20	20	20				12	12	24	20	12	24	35		N 1
7.3	1	1	1	12	12	12	12				7	7	14	12	7	14	20		N 1
7.4	1	1	1					15	15	20	5	5	10		5	10	15		N 2
8.1																	30		O
8.2	1	1	1	8	8	8	8	10	10	15	5	5	10	8	5	10			O
8.3	1	1	1								3	3	6		3	6			O
9.1																			H
10.1																			O

	M	M	M	M	M	M	M	M	M	M	M	M	M	M	M	M	M	
	DIN 37610 37612	DIN 37610 37612	DIN 37610 37612	DIN 37610 37612	DIN 37610 37612	DIN 37610 37612	DIN 37610 37612	DIN 37610 37612	DIN 37610 37612	DIN 37610 37612	ISO 529	ISO 529	ISO 529	ISO 529	ISO 2283	DIN 371	DIN 376	
	6G	6H	6H	6H	6H	6H	6H	6H	6H	6H	6H	6H	6H	6H	6H	6H	6H	
	2.5XD	2.5XD	2.5XD	2.5XD	2.5XD	2.5XD	2.5XD	2.5XD	2.5XD	2.5XD	2.5XD	2.5XD	2.5XD	1XD	2.5XD	3XD	3XD	
	HSS-E	HSS-E	HSS-E	HSS-E PM	HSS-E PM	HSS-E PM	HSS-E PM	HSS-E PM	HSS-E PM	HSS-E PM	HSS-E	HSS-E	HSS-E	HSS	HSS-E	HSS-E	HSS-E	
	B 3.5-5	B 3.5-5	B 3.5-5	B 3.5-5	B 3.5-5	B 3.5-5	B 3.5-5	B 3.5-5	B 3.5-5	B 3.5-5	B 3.5-5	B 3.5-5	B 3.5-5	B 3.5-5	B 3.5-5	B 3.5-5	B 3.5-5	
		TN	ST	Cr		TiAlN Top	ST	Super 8		Super 8		TN	ST					
	EP006G	EP00TIN	EP016H	E297	E255	E256	E240	E241	E471	E472	E000	E000TIN	E001	E510	E606	E216	E266	
	M3 - M20	M3 - M30	M2 - M30	M3 - M30	M3 - M20	M3 - M20	M3 - M30	M3 - M20	M3 - M20	M3 - M20	M1.6 - M24	M3 - M20	M1.6 - M24	M3 - M10	M3 - M24	M3 - M10	M12 - M24	
	NEW			NEW	NEW	NEW	NEW	NEW	NEW	NEW								
AMG	210	210	210	212	213	213	214	214	215	215	216	216	216	217	218	219	219	ISO
1.1	■25	■40	■25	■25					●25		■25	■40	■25		●20	●22	●22	P 1
1.2	■22	■40	■22	■22					●22	■40	■22	■40	■22		●18	■20	■20	P 1
1.3	■18	■32	■18	■18					●32	●18	■18	■32	■18		●14	■16	■16	P 2
1.4	■16	■27	■16	■16	■16	■30			●27		■16	■27	■16		●10	■12	■12	P 3
1.5	■10	■13	■10	●10	●7	■17	●10	●17			■10	■13	■10	●7	●5	●7	●7	P 4
1.6	●5	●11	●5		●4	●11	●5	●11			●5	●11	●5	●4	●3			H 1
1.7																		H 3
1.8																		H 4
2.1		■8	●7				■8	■14				■8	●7	●7	●6			M 1
2.2		■7	●6				■7	■10				■7	●6	●5	●4			M 3
2.3		●5	●4				■5	■6				●5	●4	●7	●3			M 2
2.4																		S 2
3.1	●15	●22	●15								●15	●22	●15	●12		●12	●12	K 1
3.2	●8	●18	●8								●8	●18	●8	●7		●7	●7	K 2
3.3	●15	●25	●15								●15	●25	●15	●10		●10	●10	K 3
3.4	●8	●18	●8								●8	●18	●8			●5	●5	K 4
4.1	●10	●15								■25	●10	●15				●15	●15	S 1
4.2	●5	●7			●5	●10					●5	●7						S 2
4.3																		S 3
5.1	●12	●18								■25	●12	●18		●3	●4	●4		S 3
5.2	●5	●8			●5	●10					●5	●8		●4	●5	●5		S 2
5.3																		S 3
6.1	■12	■18		■12					●12		■12	■18			●10	●12	●12	N 3
6.2	●30	●45		●30					■30	■45	●30	●45			●30	●30	●30	N 4
6.3	■20	■35		■20					■20	●35	■20	■35			●15	●20	●20	N 3
6.4																		N 4
7.1	■16								■16	●35	■16				●10	●16	●16	N 1
7.2	■35								■35	■45	■35				●25	●35	●35	N 1
7.3	■20	■30							■20	■30	■20	■30			●13	●20	●20	N 1
7.4	■15	■22							●15	■20	■15	■22			●10	●15	●15	N 2
8.1	●30								■25	●30	●30				●20	●25	●25	O
8.2		●45											●45					O
8.3																		O
9.1																		H
10.1																		O

	M	M	M	M	M	M	M	M	M	M	M	M	M	M	M	M	M	
	DIN 371	DIN 376	DIN 371	DIN 376	DIN 371	DIN 376	ISO 529	DIN 376c10 376b12	DIN 376c10 376b12	DIN 376c10 376b12	DIN 376c10 376b12	DIN 376c10 376b12	DIN 376c10 376b12	DIN 376c10 376b12	DIN 376c10 376b12	DIN 376c10 376b12	DIN 376c10 376b12	
	6H	6H	6H	6H	6H	6H	6H	6H	6G	6H	6H	6H	6H	6H	6H	6H	6H	
	3XD	3XD	1.5XD	1.5XD	1.5XD	1.5XD	2XD	2.5XD	2.5XD	2.5XD	2.5XD	2.5XD	2XD	2.5XD	2.5XD	2.5XD	2.5XD	
	HSS-E	HSS-E	HSS-E	HSS-E	HSS-E	HSS-E	HSS-E	HSS-E	HSS-E	HSS-E	HSS-E	HSS-E	HSS-E PM	HSS-E PM	HSS-E PM	HSS-E PM	HSS-E PM	
	B 3.5-5	B 3.5-5	C 2-3	C 2-3	C 2-3	C 2-3	C 2-3	C 2-3	C 2-3	C 2-3	C 2-3	C 2-3	C 2-3	C 2-3	C 2-3	C 2-3	C 2-3	
	$\lambda 15^\circ$	$\lambda 15^\circ$	$\lambda 15^\circ$	$\lambda 15^\circ$	$\lambda 15^\circ$	$\lambda 15^\circ$	$\lambda 15^\circ$	$\lambda 15^\circ$	$\lambda 45^\circ$	$\lambda 45^\circ$	$\lambda 45^\circ$	$\lambda 45^\circ$	$\lambda 40^\circ$	$\lambda 45^\circ$	$\lambda 45^\circ$	$\lambda 40^\circ$	$\lambda 35^\circ$	
	TN	TN			TN	TN			TN	ST	Gr		TN Top	ST	Super 8			
	E422	E423	E207	E258	E212	E263	E052	EX006H	EX006G	EX00TIN	EX016H	E298	E260	E261	E238	E239	E473	
	M3 - M10	M12 - M24	M2 - M10	M4 - M36	M3 - M10	M12 - M36	M3 - M16	M2 - M64	M3 - M20	M3 - M30	M2 - M64	M3 - M30	M3 - M20	M3 - M20	M3 - M30	M3 - M20	M3 - M20	
												NEW	NEW	NEW	NEW	NEW	NEW	
AMG	219	219	221	221	221	221	223	224	224	224	224	225	226	226	227	227	228	ISO
1.1	35	35			35	35	25	25	25	40	25	25					25	P 1
1.2	35	35			35	35	22	22	22	40	22	22					22	P 1
1.3	28	28	16	16	28	28	18	18	18	32	18	18				32	18	P 2
1.4	24	24	12	12	24	24	16	16	16	27	16	16	16	30		27		P 3
1.5	10	10	7	7	10	10	10	10	10	13	10	10	7	20	10	13		P 4
1.6													4	11	5	11		H 1
1.7																		H 3
1.8																		H 4
2.1										8	7				8	14		M 1
2.2										7	6				7	10		M 3
2.3										5	4				5	6		M 2
2.4																		S 2
3.1	18	18										22						K 1
3.2	15	15										18						K 2
3.3	20	20										25						K 3
3.4	15	15										18						K 4
4.1	27	27						10	10	15								S 1
4.2					10	10		5	5	7			5	10				S 2
4.3	5	5			7	7												S 3
5.1	20	20						12	12	18								S 1
5.2	8	8						5	5	8			5	10				S 2
5.3																		S 3
6.1	18	18					12					12					12	N 3
6.2	45	45					30					30					30	N 4
6.3	35	35					20					20					20	N 3
6.4																		N 4
7.1	25	25					16	16	16								16	N 1
7.2	45	45	30	30	35	35	35	35	35								35	N 1
7.3	30	30	15	15	20	20	20	20	20	30							20	N 1
7.4	20	20					15	15	15	22							15	N 2
8.1	30	30															25	O
8.2																		O
8.3																		O
9.1																		H
10.1																		O









	M	M	M	M	M	M	M	M	M	M	M	M	MF	MF	MF	MF	MF		
	DIN 37610 37612	ISO 529	ISO 529	ISO 529	DORMER ISO	ISO 2283	DIN 2174	DIN 2174	DIN 2174	DIN 2174	DIN 2174	DIN 2174	DIN 2181	DIN 374	DIN 371	DIN 374	ISO 529		
	6H	6H	6H	6H	6H	6H	6HX	6HX	6HX	6HX	6GX	6GX	6H	6H	6H	6H	6H		
	2.5XD	2.5XD	2.5XD	2.5XD	1.5XD	2XD	3XD	3XD	3XD	3.5XD	3XD	3XD	1.5XD	1.5XD	1.5XD	1.5XD	1.5XD		
	HSS-E PM	HSS-E	HSS-E	HSS-E	HSS	HSS-E	HSS-E	HSS-E	HSS-E	HSS-E	HSS-E	HSS-E	HSS	HSS-E	HSS-E	HSS-E	HSS		
	C 2-3	C 2-3	C 2-3	C 2-3	C 2-3	C 2-3	C 2-3.5	C 2-3.5	E 1.5-2	C 2-3.5	C 2-3.5	E 1.5-2	C 2-3	C 2-3	C 2-3	C 2-3			
	M3 - M20	M2 - M24	M3 - M20	M2 - M24	M3 - M16	M3 - M20	M1.6 - M16	M1.6 - M16	M3 - M10	M3 - M16	M3 - M12	M3 - M10	M2.5 - M50	M4 - M50	M8 - M10	M12 - M24	M3 - M50		
	NEW						NEW	NEW	NEW	NEW	NEW	NEW							
AMG	228	229	229	229	230	231	232	232	232	232	233	233	234	237	237	237	239	ISO	
1.1		■25	■40	■25	■25		■30	■55	■55	■55	■55	■55	■55	■1	■12	■12	■12	■7	P 1
1.2	■40	■22	■40	■22	■22	■18	■27	■50	■50	■50	■50	■50	■50	■1	■10	■10	■10	■6	P 1
1.3	■32	■18	■32	■22	■18	■14	■23	■45	■45	■45	■45	■45	■45	■1	■8	■8	■8	■5	P 2
1.4		■16	■27	■16	■15	■10	■20	■40	■40	■40	■40	■40	■40	■1	■6	■6	■6	■4	P 3
1.5		■10	■13	■10		■5		■20	■20	■20	■20	■20	■20	■1	■5	■5	■5	■3	P 4
1.6																			H 1
1.7																			H 3
1.8																			H 4
2.1		■8	■7		■6		■18	■18	■18	■18	■18	■18							M 1
2.2		■7	■6		■4		■15	■15	■15	■15	■15	■15							M 3
2.3		■5	■4		■3		■10	■10	■10	■10	■10	■10							M 2
2.4																			S 2
3.1		■22											■1	■14	■14	■14	■12		K 1
3.2		■18		■8									■1	■8	■8	■8	■7		K 2
3.3		■25											■1	■12	■12	■12	■10		K 3
3.4		■18											■1				■5		K 4
4.1	■25	■10	■15				■35	■35	■35	■35	■35	■35							S 1
4.2		■5	■7																S 2
4.3																			S 3
5.1	■25	■12	■18				■20	■20	■20	■20	■20	■20							S 1
5.2		■5	■8		■4		■8	■8	■8	■8	■8	■8							S 2
5.3																			S 3
6.1							■25	■25	■25	■25	■25	■25	■1				■4		N 3
6.2	■45				■30								■1	■16	■16	■16	■10		N 4
6.3	■35				■20		■40	■40	■40	■40	■40	■40	■1	■12	■12	■12	■7		N 3
6.4													■1				■2		N 4
7.1	■35	■16			■18	■10	■26	■55	■55	■55	■55	■55							N 1
7.2	■45	■35			■35	■25	■38	■55	■55	■55	■55	■55	■1	■20	■20	■20	■12		N 1
7.3	■30	■20	■30		■13	■22	■40	■40	■40	■40	■40	■40	■1	■12	■12	■12	■7		N 1
7.4	■20	■15	■22		■10		■25	■25	■25	■25	■25	■25	■1				■5		N 2
8.1	■30				■30														O
8.2													■1	■8	■8	■8	■5		O
8.3													■1				■3		O
9.1																			H
10.1																			O

	MF	MF	MF	MF	MF	MF	MF	MF	MF	MF	MF	MF	UNC	UNC	UNC	UNC	UNC	
	DIN 374	DIN 374	DIN 374	DIN 374	DIN 374	ISO 529	DIN 374	DIN 374	DIN 374	DIN 374	DIN 374	DIN 374	ISO 529	DIN 352	DIN 371	DIN 376	ISO 529	DIN 2184-1
	6H	6H	6H	6H	6H	6H	6H	6H	6H	6H	6H	6H	2B	2B	2B	2B	2B	
	2.5XD	2.5XD	2.5XD	2.5XD	2.5XD	2.5XD	2.5XD	2.5XD	2.5XD	2.5XD	2.5XD	2.5XD	1.5XD	1.5XD	1.5XD	1.5XD	1.5XD	
	HSS-E	HSS-E	HSS-E	HSS-E PM	HSS-E PM	HSS-E	HSS-E	HSS-E	HSS-E	HSS-E PM	HSS-E PM	HSS-E	HSS	HSS-E	HSS-E	HSS	HSS-E	
	B	B	B	B	B	B	C	C	C	C	C	C	C	C	C		B	
	3,5-5	3,5-5	3,5-5	3,5-5	3,5-5	3,5-5	2-3	2-3	2-3	2-3	2-3	2-3	2-3	2-3	2-3		3,5-5	
							$\lambda 45^\circ$	$\lambda 45^\circ$	$\lambda 45^\circ$	$\lambda 40^\circ$	$\lambda 40^\circ$	$\lambda 45^\circ$						
							$\lambda 45^\circ$	$\lambda 45^\circ$	$\lambda 45^\circ$	$\lambda 40^\circ$	$\lambda 40^\circ$	$\lambda 45^\circ$						
	EP10	EP10TIN	EP11	E299	E384	E011	EX10	EX10TIN	EX11	E300	E383	E013	E108	E225	E275	E515	EP20	
	M4 - M30	M8 - M20	M4 - M30	M4 - M30	M6 - M20	M4 - M24	M4 - M30	M8 - M20	M4 - M30	M4 - M30	M6 - M20	M4 - M22	No.5 - 1"	No.2 - 1/4	5/16 - 1.1/2	No.1 - 2"	No.4 - 1"	
				NEW	NEW					NEW	NEW							
AMG	243	243	243	245	246	247	248	248	248	250	251	252	253	254	254	255	257	ISO
1.1	25	40	25	25		25	25	40	25	25		25	1	12	12	7	25	P 1
1.2	22	40	22	22		22	22	40	22	22		22	1	10	10	6	22	P 1
1.3	18	32	18	18		18	18	32	18	18		18	1	8	8	5	18	P 2
1.4	16	27	16	16		16	16	27	16	16		16	1	6	6	4	16	P 3
1.5	10	13	10	10	10	10	10	13	10	10	10	10	1	5	5	3	10	P 4
1.6	5	11	5		5	5					5						5	H 1
1.7																		H 3
1.8																		H 4
2.1		8	7		8	7		8	7		8	7						M 1
2.2		7	6		7	6		7	6		7	6						M 3
2.3		5	4		5	4		5	4		5	4						M 2
2.4																		S 2
3.1	15	22	15			15		22					1	14	14	12	15	K 1
3.2	8	18	8			8		18					1	8	8	7	8	K 2
3.3	15	25	15			15		25					1	12	12	10	15	K 3
3.4	8	18	8			8		18					1			5	8	K 4
4.1	10	15					10	15									10	S 1
4.2	5	7					5	7									5	S 2
4.3																		S 3
5.1	12	18					12	18									12	S 1
5.2	5	8					5	8									5	S 2
5.3																		S 3
6.1	12	18		12						12			1			4	12	N 3
6.2	30	45		30						30			1	16	16	10	30	N 4
6.3	20	35		20						20			1	12	12	7	20	N 3
6.4													1			2		N 4
7.1	16						16										16	N 1
7.2	35						35						1	20	20	12	35	N 1
7.3	20	30					20	30					1	12	12	7	20	N 1
7.4	15	22					15	22					1			5	15	N 2
8.1	30																30	O
8.2		45											1	8	8	5		O
8.3													1			3		O
9.1																		H
10.1																		O





	UNC	UNC	UNC	UNC	UNC	UNC	UNF	UNF	UNF	UNF	UNF	UNF	UNF	UNF	UNF	UNF	UNF	
	DIN 2184-1	ISO 529	DIN 2184-1	DIN 2184-1	ISO 529	DORMER DIN	DIN 2181	DIN 371	DIN 374	ISO 529	DIN 2184-1	DIN 2184-1	ISO 529	DIN 2184-1	DIN 2184-1	ISO 529	DORMER DIN	
	2B	2B	2B	2B	2B	2B	2B	2B	2B	2B	2B	2B	2B	2B	2B	2B	2B	Medium
	2.5XD	2.5XD	2.5XD	2.5XD	2.5XD	1.5XD	1.5XD	1.5XD	1.5XD	1.5XD	2.5XD	2.5XD	2.5XD	2.5XD	2.5XD	2.5XD	1.5XD	
	HSS-E	HSS-E	HSS-E	HSS-E	HSS-E	HSS	HSS	HSS-E	HSS-E	HSS	HSS-E	HSS-E	HSS-E	HSS-E	HSS-E	HSS-E	HSS	
	B 3.5-5	B 3.5-5	C 2-3	C 2-3	C 2-3	C 2-3	C 2-3	C 2-3	C 2-3		C 2-3	C 2-3	B 3.5-5	C 2-3	C 2-3	C 2-3	C 2-3	
	ST	ST	$\lambda 45^\circ$	$\lambda 45^\circ$	$\lambda 45^\circ$	$\lambda 30^\circ$							$\lambda 45^\circ$	$\lambda 45^\circ$	$\lambda 45^\circ$	$\lambda 30^\circ$		
	EP21	E021	EX20	EX21	E023	E651	E111	E229	E278	E524	EP30	EP31	E031	EX30	EX31	E033	E654	
	No.4 - 1"	No.2 - 1"	No.4 - 1"	No.4 - 1"	No.2 - 1"	No.6 - 5/8	No.5 - 1"	No.2 - 1/4	5/16 - 1.1/2	No.0 - 1.1/2	No.8 - 1"	No.8 - 1"	No.8 - 1"	No.8 - 1"	No.8 - 1"	No.8 - 1"	No.8 - 5/8	
AMG	257	258	259	259	260	261	262	263	263	264	266	266	267	268	268	269	270	ISO
1.1	■25	■25	■25	■25	■25	■25	■1	■12	■12	■7	■25	■25	■25	■25	■25	■25	■25	P 1
1.2	■22	■22	■22	■22	■22	■22	■1	■10	■10	■6	■22	■22	■22	■22	■22	■22	■22	P 1
1.3	■18	■18	■18	■18	■18	■18	■1	■8	■8	■5	■18	■18	■18	■18	■18	■18	■18	P 2
1.4	■16	■16	■16	■16	■16	■16	■1	■6	■6	■4	■16	■16	■16	■16	■16	■16	■16	P 3
1.5	■10	■10	■10	■10	■10	■10	■1	■5	■5	■3	■10	■10	■10	■10	■10	■10	■10	P 4
1.6	■5	■5									■5	■5	■5			■5		H 1
1.7																		H 3
1.8																		H 4
2.1	■7	■7		■7	■7							■7	■7			■7	■7	M 1
2.2	■6	■6		■6	■6							■6	■6			■6	■6	M 3
2.3	■4	■4		■4	■4							■4	■4			■4	■4	M 2
2.4																		S 2
3.1	■15	■15					■1	■14	■14	■12	■15	■15	■15					K 1
3.2	■8	■8				■8	■1	■8	■8	■7	■8	■8	■8				■8	K 2
3.3	■15	■15					■1	■12	■12	■10	■15	■15	■15					K 3
3.4	■8	■8					■1			■5	■8	■8	■8					K 4
4.1			■10								■10			■10				S 1
4.2			■5								■5			■5				S 2
4.3																		S 3
5.1			■12								■12			■12				S 1
5.2			■5								■5			■5				S 2
5.3																		S 3
6.1							■1			■4	■12							N 3
6.2						■30	■1	■16	■16	■10	■30						■30	N 4
6.3						■20	■1	■12	■12	■7	■20						■20	N 3
6.4							■1			■2								N 4
7.1		■16				■18					■16			■16			■18	N 1
7.2		■35				■35	■1	■20	■20	■12	■35			■35			■35	N 1
7.3		■20					■1	■12	■12	■7	■20			■20			■20	N 1
7.4		■15					■1			■5	■15			■15			■15	N 2
8.1						■30					■30						■30	O
8.2							■1	■8	■8	■5								O
8.3							■1			■3								O
9.1																		H
10.1																		O

	UN	BSW	BSW	BSW	BSW	BSF	BSF	BSF	BA	BA	BA	G	G	G	G	G	G
	ISO 529	DIN 351	ISO 529	ISO 529	ISO 529	ISO 529	ISO 529	ISO 529	ISO 529	ISO 529	ISO 529	DIN 5157	DIN 5156	ISO 2284	DIN 5156	DIN 5156	DORMER ISO
	2B	Medium	Medium	Medium	Medium	Medium	Medium	Medium	Normal	Normal	Normal	Normal	Normal	Normal	Normal	Normal	Normal
	HSS	HSS	HSS	HSS	HSS	HSS	HSS	HSS	HSS	HSS	HSS	HSS	HSS-E	HSS	HSS-E	HSS-E	HSS-E
	C 2-3	C 2-3		B 3,5-5	C 2-3		B 3,5-5	C 2-3		B 3,5-5	C 2-3	C 2-3	C 2-3		B 3,5-5	B 3,5-5	B 3,5-5

	G	G	G	G	EGM	EGM	Rc	NPT	NPT	NPT	NPT	NPT	NPTF	NPSF	NPSF	NPSM	PG	
	DIN 5156	DIN 5156	DIN 5156	DORMER ISO	DORMER ISO	DORMER ISO	ISO 2284	DORMER ANSI	ANSI B94.9	ANSI B94.9	ANSI B94.9	ANSI	ANSI B94.9	ANSI B94.9	ANSI B94.9	ANSI B94.9	DIN 40432	
	Normal	Normal	Normal	Normal	6H	6H	Normal	Normal	Normal	Normal	Normal	Normal	Normal	Normal	Normal	Normal	Normal	
	2.5XD	2.5XD	2XD	2.5XD	1.5XD	2XD	1.5XD	1.5XD	1.5XD	1.5XD	1.5XD	1.5XD	1.5XD	1.5XD	1.5XD	1.5XD	1.5XD	
	HSS-E	HSS-E	HSS-E PM	HSS-E	HSS	HSS	HSS	HSS-E	HSS	HSS	HSS	HSS	HSS	HSS	HSS	HSS	HSS	
	C 2-3	C 2-3	C 2-3	C 2-3	C 2-3	C 2-3	C 2-3	C 2-3	C 2-3	C 2-3	C 2-3		C 2-3					
	λ45°	λ45°	λ40°	λ45°		λ40°						λ27°						
	EX40	EX41	E382	E043	E620	E621	E550	E714	E710	E721	E711	E653	E712	E709	E720	E708	E243	
	1/8 - 1.1/2	1/8 - 1.1/2	1/8 - 1"	1/8 - 3/4	M3 - M16	M3 - M16	1/8 - 2"	1/8 - 1"	1/16 - 2"	1/8 - 1"	1/8 - 1.1/2	1/8 - 1"	1/16 - 1.1/4	1/8 - 3/4	1/8 - 3/4	1/8 - 1"	No.7 - No.36	
			NEW															
AMG	288	288	289	290	291	292	293	294	295	295	296	297	298	299	299	300	301	ISO
1.1	■25	■25		■25	■7		■22	■4	■4	■4	■4	■25	■4	■4	■4	■4	■12	P 1
1.2	■22	■22		■22	■6	■18	■20	■4	■4	■4	■4	■22	■4	■4	■4	■4	■10	P 1
1.3	■18	■18		■18	■5	■14	■16	■6	■6	■6	■6	■18	■6	■6	■6	■6	■8	P 2
1.4	■16	■16		■16	■4	■10	■12	■5	■5	■5	■5	■15	■5	■5	■5	■5	■6	P 3
1.5	■10	■10	■10	■10	■3	■5	■7	■3	■3	■3	■3		■3	■3	■3	■3	■5	P 4
1.6			■5	■5			■4											H 1
1.7																		H 3
1.8																		H 4
2.1		■7	■8	■7		■6	■7											M 1
2.2		■6	■7	■6		■4	■5											M 3
2.3		■4	■5	■4		■3	■7											M 2
2.4																		S 2
3.1					■12		■12	■6	■6	■6	■6		■6	■6	■6	■6	■14	K 1
3.2					■7		■7	■4	■4	■4	■4	■8	■4	■4	■4	■4	■8	K 2
3.3					■10		■10	■6	■6	■6	■6		■6	■6	■6	■6	■12	K 3
3.4					■5		■5	■4	■4	■4	■4		■4	■4	■4	■4	■4	K 4
4.1	■10																	S 1
4.2	■5																	S 2
4.3																		S 3
5.1	■12																	S 1
5.2	■5					■4												S 2
5.3																		S 3
6.1					■4		■12											N 3
6.2					■10		■30	■11	■11	■11	■11	■30	■11	■11	■11	■11	■16	N 4
6.3					■7		■20					■20					■12	N 3
6.4					■2		■4											N 4
7.1	■16				■10							■18						N 1
7.2	■35				■12	■25	■35					■35					■20	N 1
7.3	■20				■7	■13	■20	■11	■11	■11	■11		■11	■11	■11	■11	■12	N 1
7.4	■15				■5	■10	■15	■7	■7	■7	■7		■7	■7	■7	■7	■7	N 2
8.1	■30							■4	■4	■4	■4	■30	■4	■4	■4	■4		O
8.2					■5		■12										■8	O
8.3					■3		■7											O
9.1																		H
10.1																		O

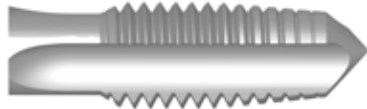
									
	L110	L111	L119	L126	L113	L114	L115	L120	
	16.00 - 4"	No.0 - BT2	Set	Set	Set	Set	Set	Set	
					NEW	NEW	NEW		
AMG	302	303	304	305	306	307	308	309	ISO
1.1									P 1
1.2									P 1
1.3									P 2
1.4									P 3
1.5									P 4
1.6									H 1
1.7									H 3
1.8									H 4
2.1									M 1
2.2									M 3
2.3									M 2
2.4									S 2
3.1									K 1
3.2									K 2
3.3									K 3
3.4									K 4
4.1									S 1
4.2									S 2
4.3									S 3
5.1									S 1
5.2									S 2
5.3									S 3
6.1									N 3
6.2									N 4
6.3									N 3
6.4									N 4
7.1									N 1
7.2									N 1
7.3									N 1
7.4									N 2
8.1									O
8.2									O
8.3									O
9.1									H
10.1									O

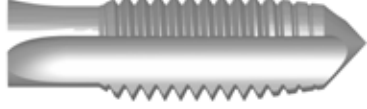
NO1 - NO9

NO1 =		A 6-8	
NO2 =		B 4-6	
NO3 =		C 2-3	

ISO	NO6 = NO1 + NO2 + NO3
	NO7 = NO2 + NO3 *

ANSI	NO6 = NO1 (taper) + NO2 (plug) + NO3 (bottoming)
------	--

NO4 =		A 6-8	
NO5 =		B 3.5-5	

DIN	NO8 = NO3 + NO4 + NO5
ISO	NO9 = NO3 + NO4

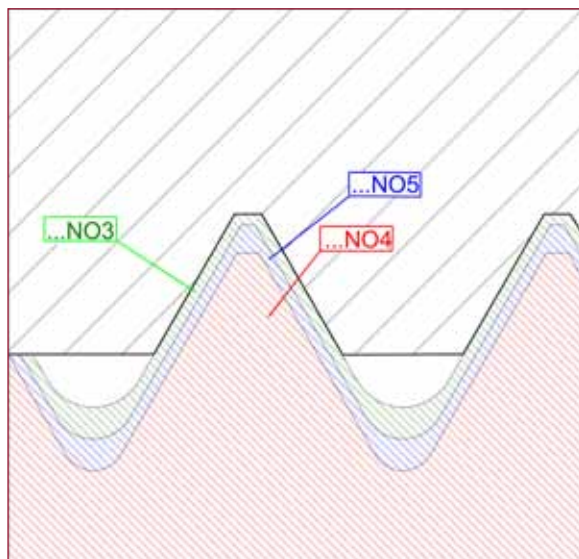

* E550
E710 NO7 = NO3 (truncated) + NO3

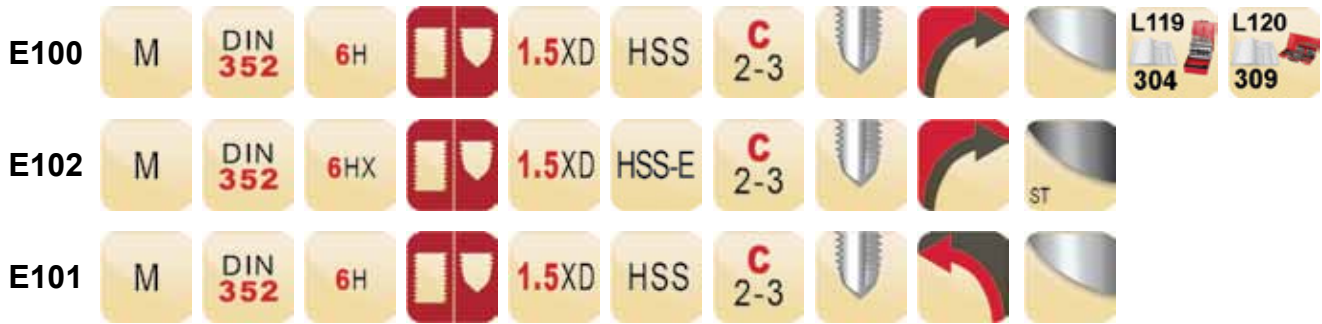

- E100** • M 手用丝锥 直槽
- E102** • M Macho Manual Canal Reto
- E101** • M Machos de mano Estrías rectas
- E101** • M Hand Tap Straight Flute

E100	•	1.1	1.2	1.3	1.4	1.5	3.1	3.2	3.3	3.4	6.1	6.2	6.3	6.4	7.2	7.3	7.4	8.2	8.3		
E102	•	1.1	1.2	1.3	1.4	1.5	2.1	2.2	2.3	3.1	3.2	3.3	3.4	4.1	4.2	4.3	5.1	5.2	5.3	6.1	6.2
		6.3	6.4	7.2	7.3	7.4	8.2	8.3													
E101	•	1.1	1.2	1.3	1.4	1.5	3.1	3.2	3.3	3.4	6.1	6.2	6.3	6.4	7.2	7.3	7.4	8.2	8.3		

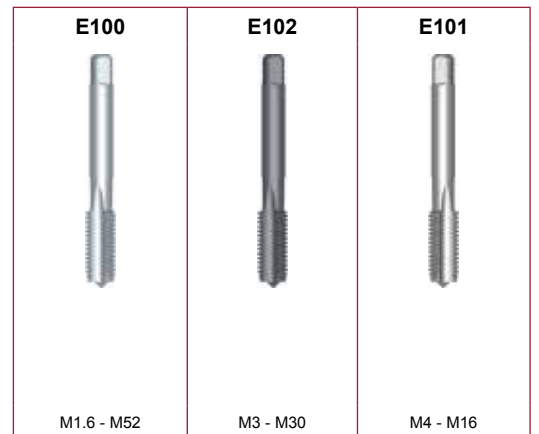
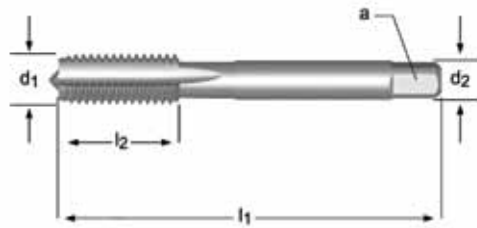

M	P mm	l ₁ mm	l ₂ mm	d ₂ Ø mm	a mm	z		E100	E102	E101
1.6	0.35	32	7	2.5	2.1	3	1.25	E100M1.6NO3		
1.6	0.35	32	7	2.5	2.1	3	1.25	E100M1.6NO8		
1.8	0.35	32	7	2.5	2.1	3	1.5	E100M1.8NO3		
1.8	0.35	32	7	2.5	2.1	3	1.5	E100M1.8NO8		
2	0.40	36	8	2.8	2.1	3	1.6	E100M2NO3		
2	0.40	36	8	2.8	2.1	3	1.6	E100M2NO8		
2.2	0.45	36	9	2.8	2.1	3	1.75	E100M2.2NO3		
2.2	0.45	36	9	2.8	2.1	3	1.75	E100M2.2NO8		
2.5	0.45	40	9	2.8	2.1	3	2.05	E100M2.5NO3		
2.5	0.45	40	9	2.8	2.1	3	2.05	E100M2.5NO8		
3	0.50	40	10	3.5	2.7	3	2.5	E100M3NO3		
3	0.50	40	10	3.5	2.7	3	2.5	E100M3NO8	E102M3NO8	¹⁾
3.5	0.60	45	10	4.0	3.0	3	2.9	E100M3.5NO3		
3.5	0.60	45	10	4.0	3.0	3	2.9	E100M3.5NO8		
4	0.70	45	12	4.5	3.4	3	3.3	E100M4NO3		¹⁾ E101M4NO3
4	0.70	45	12	4.5	3.4	3	3.3	E100M4NO8	E102M4NO8	E101M4NO8
4.5	0.75	50	14	6.0	4.9	3	3.8	E100M4.5NO3		
4.5	0.75	50	14	6.0	4.9	3	3.8	E100M4.5NO8		
5	0.80	50	14	6.0	4.9	3	4.2	E100M5NO3		¹⁾ E101M5NO3
5	0.80	50	14	6.0	4.9	3	4.2	E100M5NO8	E102M5NO8	E101M5NO8
6	1.00	56	16	6.0	4.9	3	5	E100M6NO3		¹⁾ E101M6NO3
6	1.00	56	16	6.0	4.9	3	5	E100M6NO8	E102M6NO8	E101M6NO8

¹⁾ 4号操作指示 / NO4 com guia piloto / NO4 con guía piloto / No4 with pilot Guide

M	P mm	l ₁ mm	l ₂ mm	d ₂ ∅ mm	a mm	z		E100	E102	E101
7	1.00	56	16	6.0	4.9	3	6	E100M7NO3		
7	1.00	56	16	6.0	4.9	3	6	E100M7NO8		
8	1.25	63	19	6.0	4.9	3	6.8	E100M8NO3		E101M8NO3
8	1.25	63	19	6.0	4.9	3	6.8	E100M8NO8	E102M8NO8 ¹⁾	E101M8NO8
9	1.25	63	20	7.0	5.5	3	7.8	E100M9NO3		
9	1.25	63	20	7.0	5.5	3	7.8	E100M9NO8		
10	1.50	70	22	7.0	5.5	3	8.5	E100M10NO3		E101M10NO3
10	1.50	70	22	7.0	5.5	3	8.5	E100M10NO8	E102M10NO8 ¹⁾	E101M10NO8
11	1.50	70	20	8.0	6.2	3	9.5	E100M11NO3		
11	1.50	70	20	8.0	6.2	3	9.5	E100M11NO8		
12	1.75	75	25	9.0	7.0	4	10.3	E100M12NO3		E101M12NO3
12	1.75	75	25	9.0	7.0	4	10.3	E100M12NO8	E102M12NO8 ¹⁾	E101M12NO8
14	2.00	80	25	11.0	9.0	4	12	E100M14NO3		E101M14NO3
14	2.00	80	25	11.0	9.0	4	12	E100M14NO8	E102M14NO8 ¹⁾	E101M14NO8
16	2.00	80	25	12.0	9.0	4	14	E100M16NO3		E101M16NO3
16	2.00	80	25	12.0	9.0	4	14	E100M16NO8	E102M16NO8 ¹⁾	E101M16NO8
18	2.50	95	32	14.0	11.0	4	15.5	E100M18NO3		
18	2.50	95	32	14.0	11.0	4	15.5	E100M18NO8	E102M18NO8 ¹⁾	
20	2.50	95	32	16.0	12.0	4	17.5	E100M20NO3		
20	2.50	95	32	16.0	12.0	4	17.5	E100M20NO8	E102M20NO8 ¹⁾	
22	2.50	100	34	18.0	14.5	4	19.5	E100M22NO3		
22	2.50	100	34	18.0	14.5	4	19.5	E100M22NO8		
24	3.00	110	38	18.0	14.5	4	21	E100M24NO3		
24	3.00	110	38	18.0	14.5	4	21	E100M24NO8	E102M24NO8 ¹⁾	
27	3.00	110	38	20.0	16.0	4	24	E100M27NO3		
27	3.00	110	38	20.0	16.0	4	24	E100M27NO8	E102M27NO8 ¹⁾	
30	3.50	125	45	22.0	18.0	4	26.5	E100M30NO3		
30	3.50	125	45	22.0	18.0	4	26.5	E100M30NO8	E102M30NO8 ¹⁾	
33	3.50	125	50	25.0	20.0	4	29.5	E100M33NO3		
33	3.50	125	50	25.0	20.0	4	29.5	E100M33NO8		
36	4.00	150	56	28.0	22.0	4	32	E100M36NO3		
36	4.00	150	56	28.0	22.0	4	32	E100M36NO8		
39	4.00	150	60	32.0	24.0	4	35	E100M39NO3		
39	4.00	150	60	32.0	24.0	4	35	E100M39NO8		
42	4.50	150	60	32.0	24.0	4	37.5	E100M42NO3		
42	4.50	150	60	32.0	24.0	4	37.5	E100M42NO8		
45	4.50	160	65	36.0	29.0	6	40.5	E100M45NO3		
45	4.50	160	65	36.0	29.0	6	40.5	E100M45NO8		
48	5.00	180	70	36.0	29.0	6	43	E100M48NO3		
48	5.00	180	70	36.0	29.0	6	43	E100M48NO8		
52	5.00	180	70	40.0	32.0	6	47	E100M52NO3		
52	5.00	180	70	40.0	32.0	6	47	E100M52NO8		

¹⁾ 4号操作指示 / NO4 com guia piloto / NO4 con guía piloto / No4 with pilot Guide

E200	M	DIN 371	6H		1.5XD	HSS-E	A 6-8 C 2-3			
E250	M	DIN 376	6H		1.5XD	HSS-E	A 6-8 C 2-3			
E237	M	DIN 371	6H		1.5XD	HSS-E	C 2-3			
E251	M	DIN 376	6H		1.5XD	HSS-E	C 2-3			

E200 • M 机用丝锥 直槽

E250 • M Macho Máquina Canal Reto

E237 • M Machos de máquina Estrías rectas

E251 • M Machine Tap Straight Flute

E200; E250; E237; E251 • 1.1 1.2 1.3 1.4 1.5 3.1 3.2 3.3 6.2 6.3 7.2 7.3 8.2

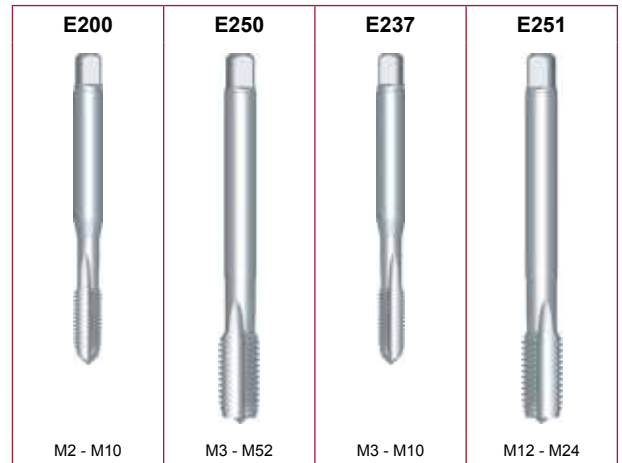
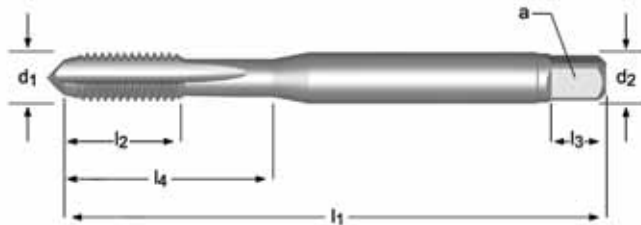

M	P mm	l ₁ mm	l ₂ mm	d ₂ Ø mm	a mm	l ₃ mm	z	l ₄ mm	E200	E250	E237	E251
2	0.40	45	6	2.8	2.1	5	3	1.6	9	E200M2		
2.2	0.45	45	7	2.8	2.1	5	3	1.75	12	E200M2.2		
2.5	0.45	50	8	2.8	2.1	5	3	2.05	12.5	E200M2.5		
3	0.50	56	10	2.2	2.1	5	3	2.5		E250M3		
3	0.50	56	9	3.5	2.7	6	3	2.5	18	E200M3	E237M3	
3	0.50	56	9	3.5	2.7	6	3	2.5	18	E200M3NO1		
3.5	0.60	56	11	2.5	2.1	5	3	2.9		E250M3.5		
3.5	0.60	56	11	4.0	3.0	6	3	2.9	20	E200M3.5		
4	0.70	63	12	2.8	2.1	5	3	3.3		E250M4		
4	0.70	63	12	4.5	3.4	6	3	3.3	21	E200M4	E237M4	
4	0.70	63	12	4.5	3.4	6	3	3.3	21	E200M4NO1		
5	0.80	70	13	3.5	2.7	6	3	4.2		E250M5		
5	0.80	70	13	6.0	4.9	8	3	4.2	25	E200M5	E237M5	
5	0.80	70	13	6.0	4.9	8	3	4.2	25	E200M5NO1		
6	1.00	80	15	4.5	3.4	6	3	5.0		E250M6		
6	1.00	80	15	6.0	4.9	8	3	5.0	30	E200M6	E237M6	
6	1.00	80	15	4.5	3.4	6	3	5.0		E250M6NO1		
6	1.00	80	15	6.0	4.9	8	3	5.0	30	E200M6NO1		
7	1.00	80	15	5.5	4.3	7	3	6.0		E250M7		
7	1.00	80	15	7.0	5.5	8	3	6.0	30	E200M7		

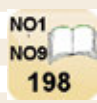
M	P mm	l ₁ mm	l ₂ mm	d ₂ ∅ mm	a mm	l ₃ mm	z	 mm	l ₄ mm	E200	E250	E237	E251
8	1.25	90	18	6.0	4.9	8	3	6.8			E250M8		
8	1.25	90	18	8.0	6.2	9	3	6.8	35	E200M8		E237M8	
8	1.25	90	18	6.0	4.9	8	3	6.8			E250M8NO1		
8	1.25	90	18	8.0	6.2	9	3	6.8	35	E200M8NO1			
10	1.50	100	20	10.0	8.0	11	3	8.5	39	E200M10		E237M10	
10	1.50	100	20	7.0	5.5	8	3	8.5			E250M10		
10	1.50	100	20	10.0	8.0	11	3	8.5	39	E200M10NO1			
10	1.50	100	20	7.0	5.5	8	3	8.5			E250M10NO1		
12	1.75	110	23	9.0	7.0	10	4	10.3					E251M12
12	1.75	110	23	9.0	7.0	10	3	10.3			E250M12		
12	1.75	110	23	9.0	7.0	10	3	10.3			E250M12NO1		
14	2.00	110	25	11.0	9.0	12	4	12.0					E251M14
14	2.00	110	25	11.0	9.0	12	3	12.0			E250M14		
14	2.00	110	25	11.0	9.0	12	3	12.0			E250M14NO1		
16	2.00	110	25	12.0	9.0	12	4	14.0					E251M16
16	2.00	110	25	12.0	9.0	12	3	14.0			E250M16		
16	2.00	110	25	12.0	9.0	12	3	14.0			E250M16NO1		
18	2.50	125	30	14.0	11.0	14	4	15.5					E251M18
18	2.50	125	30	14.0	11.0	14	3	15.5			E250M18		
18	2.50	125	30	14.0	11.0	14	3	15.5			E250M18NO1		
20	2.50	140	30	16.0	12.0	15	4	17.5					E251M20
20	2.50	140	30	16.0	12.0	15	3	17.5			E250M20		
20	2.50	140	30	16.0	12.0	15	3	17.5			E250M20NO1		
22	2.50	140	34	18.0	14.5	17	4	19.5					E251M22
22	2.50	140	34	18.0	14.5	17	4	19.5			E250M22		
22	2.50	140	34	18.0	14.5	17	4	19.5			E250M22NO1		
24	3.00	160	38	18.0	14.5	17	4	21.0					E251M24
24	3.00	160	38	18.0	14.5	17	4	21.0			E250M24		
27	3.00	160	38	20.0	16.0	19	4	24.0			E250M27		
30	3.50	180	45	22.0	18.0	21	4	26.5			E250M30		
33	3.50	180	50	25.0	20.0	23	4	29.5			E250M33		
36	4.00	200	55	28.0	22.0	25	4	32.0			E250M36		
39	4.00	200	60	32.0	24.0	27	4	35.0			E250M39		
42	4.50	200	60	32.0	24.0	27	4	37.5			E250M42		
45	4.50	220	65	36.0	29.0	32	6	40.5			E250M45		
48	5.00	250	70	36.0	29.0	32	6	43.0			E250M48		
52	5.00	250	70	40.0	32.0	35	6	47.0			E250M52		

E201	M	DIN 371	6HX		2XD	HSS-E PM	C 2-3			ST
E252	M	DIN 376	6HX		2XD	HSS-E PM	C 2-3			ST
E390	M	DIN 371 ≤ 10 376 >math>\geq 12</math>	6HX		2XD	HSS-E PM	C 2-3			TAIN

E201

- M 机用直槽丝锥，白圈鲨鱼丝锥

E252

- M Macho Máquina Canal Reto , Shark - Anel Branco

- M Macho de máquina recto Shark (Anillo Blanco)

E390

- M Machine Tap Straight Flute, White Shark

E201; E252; E390	■	3.1	3.2	3.3	8.2
	•	3.4	6.2	6.4	7.4

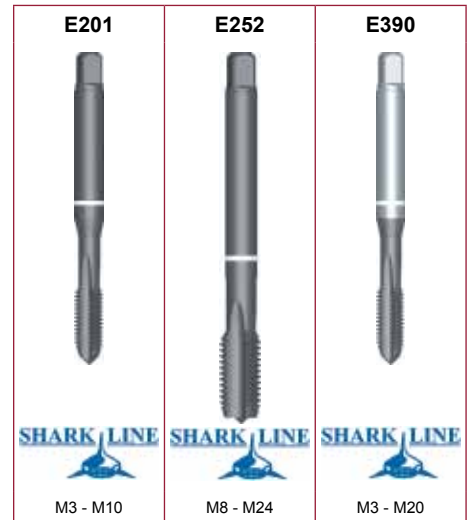
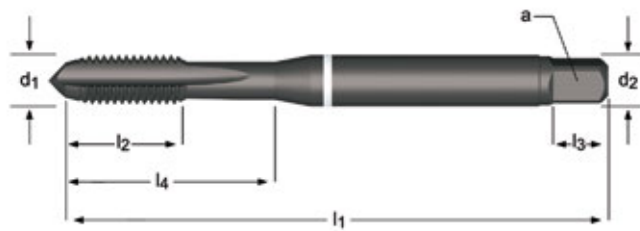

M	P mm	l ₁ mm	l ₂ mm	d ₂ ∅ mm	a mm	l ₃ mm	z		l ₄ mm	E201	E252	E390
3	0.50	56	9	3.5	2.7	6	3	2.5	18	E201M3		E390M3
4	0.70	63	12	4.5	3.4	6	4	3.3	21	E201M4		E390M4
5	0.80	70	13	6.0	4.9	8	4	4.2	25	E201M5		E390M5
6	1.00	80	15	6.0	4.9	8	4	5.0	30	E201M6		E390M6
8	1.25	90	18	6.0	4.9	8	4	6.8			E252M8	
8	1.25	90	18	8.0	6.2	9	4	6.8	35	E201M8		E390M8
10	1.50	100	20	10.0	8.0	11	4	8.5	39	E201M10		E390M10
10	1.50	100	20	7.0	5.5	8	4	8.5			E252M10	
12	1.75	110	23	9.0	7.0	10	4	10.3			E252M12	E390M12
14	2.00	110	25	11.0	9.0	12	4	12.0			E252M14	
16	2.00	110	25	12.0	9.0	12	4	14.0			E252M16	E390M16
18	2.50	125	30	14.0	11.0	14	4	15.5			E252M18	
20	2.50	140	30	16.0	12.0	15	4	17.5			E252M20	E390M20
22	2.50	140	34	18.0	14.5	17	4	19.5			E252M22	
24	3.00	160	38	18.0	14.5	17	4	21.0			E252M24	



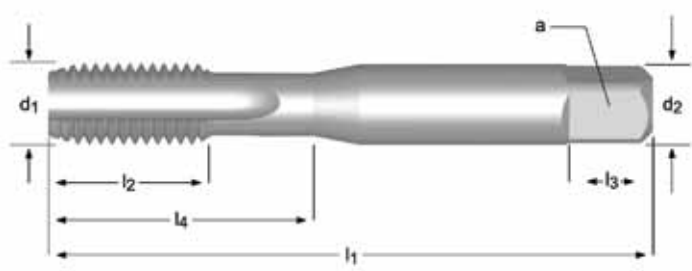

- E500** • M 机用丝锥 直槽
- E501** • M Macho Máquina Canal Reto
- E504** • M Machos de máquina Estrías rectas
- E504** • M Machine Tap Straight Flute

E500; E501	•	1.1	1.2	1.3	1.4	1.5	3.1	3.2	3.3	3.4	6.1	6.2	6.3	6.4	7.2	7.3	7.4	8.2	8.3	
E504	▪	3.1	3.2	3.3																
	•	1.1	1.2	1.3	1.4	1.5	3.4	6.2	6.3	6.4	7.2	7.3	7.4	8.2	8.3					





M	P	l ₁	l ₂	d ₂	□ a	l ₃	z	l ₄	E500	E501	E504
mm	mm	mm	mm	mm	mm	mm		mm			
1	0.25	38	4.5	2.50	2.00	4	2	0.75	4.5	E500M1NO1	
1	0.25	38	4.5	2.50	2.00	4	2	0.75	4.5	E500M1NO2	
1	0.25	38	4.5	2.50	2.00	4	2	0.75	4.5	E500M1NO3	
1.2	0.25	38	4.5	2.50	2.00	4	2	0.95	4.5	E500M1.2NO1	
1.2	0.25	38	4.5	2.50	2.00	4	2	0.95	4.5	E500M1.2NO2	
1.2	0.25	38	4.5	2.50	2.00	4	2	0.95	4.5	E500M1.2NO3	
1.4	0.30	40	6	2.50	2.00	4	2	1.1	6	E500M1.4NO1	
1.4	0.30	40	6	2.50	2.00	4	2	1.1	6	E500M1.4NO2	
1.4	0.30	40	6	2.50	2.00	4	2	1.1	6	E500M1.4NO3	
1.6	0.35	41	8	2.50	2.00	4	2	1.25	8	E500M1.6NO1	
1.6	0.35	41	8	2.50	2.00	4	2	1.25	8	E500M1.6NO2	
1.6	0.35	41	8	2.50	2.00	4	2	1.25	8	E500M1.6NO3	
1.6	0.35	41	8	2.50	2.00	4	2	1.25	8	E500M1.6NO6	
1.7	0.35	41	8	2.50	2.00	4	2	1.35	8	E500M1.7NO1	
1.7	0.35	41	8	2.50	2.00	4	2	1.35	8	E500M1.7NO2	
1.7	0.35	41	8	2.50	2.00	4	2	1.35	8	E500M1.7NO3	
1.7	0.35	41	8	2.50	2.00	4	2	1.35	8	E500M1.7NO6	
1.7	0.35	41	8	2.50	2.00	4	2	1.35	8	E500M1.7NO8	
1.8	0.35	41	8	2.50	2.00	4	2	1.45	8	E500M1.8NO1	
1.8	0.35	41	8	2.50	2.00	4	2	1.45	8	E500M1.8NO2	
1.8	0.35	41	8	2.50	2.00	4	2	1.45	8	E500M1.8NO3	
2	0.40	41	8	2.50	2.00	4	3	1.6	8	E500M2NO1	
2	0.45	41	8	2.50	2.00	4	3	1.55	8	E500M2X.45NO1	
2	0.40	41	8	2.50	2.00	4	3	1.6	8	E500M2NO2	
2	0.45	41	8	2.50	2.00	4	3	1.55	8	E500M2X.45NO2	
2	0.40	41	8	2.50	2.00	4	3	1.6	8	E500M2NO3	



M	P mm	l ₁ mm	l ₂ mm	d ₂ ∅ mm	□ a mm	l ₃ mm	z		l ₄ mm	E500	E501	E504
2	0.45	41	8	2.50	2.00	4	3	1.55	8	E500M2X.45NO3		
2	0.40	41	8	2.50	2.00	4	3	1.6	8	E500M2NO6		
2	0.40	41	8	2.50	2.00	4	3	1.6	8	E500M2NO8		
2.2	0.45	44.5	9.5	2.80	2.24	5	3	1.75	9.5	E500M2.2NO1		
2.2	0.45	44.5	9.5	2.80	2.24	5	3	1.75	9.5	E500M2.2NO2		
2.2	0.45	44.5	9.5	2.80	2.24	5	3	1.75	9.5	E500M2.2NO3		
2.3	0.45	44.5	9.5	2.80	2.24	5	3	1.85	9.5	E500M2.3NO1		
2.3	0.45	44.5	9.5	2.80	2.24	5	3	1.85	9.5	E500M2.3NO2		
2.3	0.45	44.5	9.5	2.80	2.24	5	3	1.85	9.5	E500M2.3NO3		
2.5	0.45	44.5	9.5	2.80	2.24	5	3	2.05	9.5	E500M2.5NO1		
2.5	0.45	44.5	9.5	2.80	2.24	5	3	2.05	9.5	E500M2.5NO2		
2.5	0.45	44.5	9.5	2.80	2.24	5	3	2.05	9.5	E500M2.5NO3		
2.5	0.45	44.5	9.5	2.80	2.24	5	3	2.05	9.5	E500M2.5NO6		
2.5	0.45	44.5	9.5	2.80	2.24	5	3	2.05	9.5	E500M2.5NO8		
2.6	0.45	44.5	9.5	2.80	2.24	5	3	2.15	9.5	E500M2.6NO1		
2.6	0.45	44.5	9.5	2.80	2.24	5	3	2.15	9.5	E500M2.6NO2		
2.6	0.45	44.5	9.5	2.80	2.24	5	3	2.15	9.5	E500M2.6NO3		
3	0.50	48	12.5	3.15	2.50	5	3	2.5	12.5	E500M3NO1	E501M3NO1	
3	0.60	48	12.5	3.15	2.50	5	3	2.4	12.5	E500M3X.6NO1		
3	0.50	48	12.5	3.15	2.50	5	3	2.5	12.5	E500M3NO2	E501M3NO2	
3	0.60	48	12.5	3.15	2.50	5	3	2.4	12.5	E500M3X.6NO2		
3	0.50	48	12.5	3.15	2.50	5	3	2.5	12.5	E500M3NO3	E501M3NO3	E504M3NO3
3	0.60	48	12.5	3.15	2.50	5	3	2.4	12.5	E500M3X.6NO3		
3	0.50	48	12.5	3.15	2.50	5	3	2.5	12.5	E500M3NO6		
3	0.50	48	12.5	3.15	2.50	5	3	2.5	12.5	E500M3NO7		
3	0.50	48	12.5	3.15	2.50	5	3	2.5	12.5	E500M3NO8		
3.5	0.60	50	14	3.55	2.80	5	3	2.9	14	E500M3.5NO1		
3.5	0.60	50	14	3.55	2.80	5	3	2.9	14	E500M3.5NO2		
3.5	0.60	50	14	3.55	2.80	5	3	2.9	14	E500M3.5NO3		
3.5	0.60	50	14	3.55	2.80	5	3	2.9	14	E500M3.5NO6		
4	0.70	53	14	4.00	3.15	6	3	3.3	14	E500M4NO1	E501M4NO1	
4	0.75	53	14	4.00	3.15	6	3	3.25	14	E500M4X.75NO1		
4	0.70	53	14	4.00	3.15	6	3	3.3	14	E500M4NO2	E501M4NO2	
4	0.75	53	14	4.00	3.15	6	3	3.25	14	E500M4X.75NO2		
4	0.70	53	14	4.00	3.15	6	3	3.3	14	E500M4NO3	E501M4NO3	E504M4NO3
4	0.75	53	14	4.00	3.15	6	3	3.25	14	E500M4X.75NO3		
4	0.70	53	14	4.00	3.15	6	3	3.3	14	E500M4NO6		
4	0.70	53	14	4.00	3.15	6	3	3.3	14	E500M4NO7		
4	0.70	53	14	4.00	3.15	6	3	3.3	14	E500M4NO8		
4.5	0.75	53	9.5	4.50	3.55	6	3	3.8	18	E500M4.5NO1		
4.5	0.75	53	9.5	4.50	3.55	6	3	3.8	18	E500M4.5NO2		
4.5	0.75	53	9.5	4.50	3.55	6	3	3.8	18	E500M4.5NO3		
4.5	0.75	53	9.5	4.50	3.55	6	3	3.8	18	E500M4.5NO6		
5	0.80	58	11	5.00	4.00	7	3	4.2	22	E500M5NO1		
5	0.90	58	11	5.00	4.00	7	3	4.1	22	E500M5X.9NO1		
5	0.80	58	11	5.00	4.00	7	3	4.2	22	E500M5NO2	E501M5NO2	
5	0.90	58	11	5.00	4.00	7	3	4.1	22	E500M5X.9NO2		
5	0.80	58	11	5.00	4.00	7	3	4.2	22	E500M5NO3	E501M5NO3	E504M5NO3
5	0.90	58	11	5.00	4.00	7	3	4.1	22	E500M5X.9NO3		
5	0.80	58	11	5.00	4.00	7	3	4.2	22	E500M5NO6		
5	0.80	58	11	5.00	4.00	7	3	4.2	22	E500M5NO7		
5	0.80	58	11	5.00	4.00	7	3	4.2	22	E500M5NO8		
5.5	0.90	62	12	5.60	4.50	7	3	4.6	21	E500M5.5X.9NO1		
5.5	0.90	62	12	5.60	4.50	7	3	4.6	21	E500M5.5X.9NO2		
5.5	0.90	62	12	5.60	4.50	7	3	4.6	21	E500M5.5X.9NO3		
6	1.00	66	13	6.30	5.00	8	3	5	26	E500M6NO1	E501M6NO1	
6	1.00	66	13	6.30	5.00	8	3	5	26	E500M6NO2	E501M6NO2	
6	1.00	66	13	6.30	5.00	8	3	5	26	E500M6NO3	E501M6NO3	E504M6NO3
6	1.00	66	13	6.30	5.00	8	3	5	26	E500M6NO6		
6	1.00	66	13	6.30	5.00	8	3	5	26	E500M6NO7		
6	1.00	66	13	6.30	5.00	8	3	5	26	E500M6NO8		
7	1.00	66	13	7.10	5.60	8	3	6	26	E500M7NO1		
7	1.00	66	13	7.10	5.60	8	3	6	26	E500M7NO2		
7	1.00	66	13	7.10	5.60	8	3	6	26	E500M7NO3		
7	1.00	66	13	7.10	5.60	8	3	6	26	E500M7NO6		
8	1.25	72	16	8.00	6.30	9	3	6.8	29	E500M8NO1	E501M8NO1	
8	1.25	72	16	8.00	6.30	9	3	6.8	29	E500M8NO2	E501M8NO2	
8	1.25	72	16	8.00	6.30	9	3	6.8	29	E500M8NO3	E501M8NO3	E504M8NO3
8	1.25	72	16	8.00	6.30	9	3	6.8	29	E500M8NO6		
8	1.25	72	16	8.00	6.30	9	3	6.8	29	E500M8NO7		

M	P mm	l ₁ mm	l ₂ mm	d ₂ ∅ mm	a mm	l ₃ mm	z		l ₄ mm	E500	E501	E504
8	1.25	72	16	8.00	6.30	9	3	6.8	29	E500M8NO8		
9	1.25	72	16	9.00	7.10	10	3	7.8	29	E500M9NO1		
9	1.25	72	16	9.00	7.10	10	3	7.8	29	E500M9NO2		
9	1.25	72	16	9.00	7.10	10	3	7.8	29	E500M9NO3		
9	1.25	72	16	9.00	7.10	10	3	7.8	29	E500M9NO6		
10	1.50	80	18	10.00	8.00	11	3	8.5	34	E500M10NO1	E501M10NO1	
10	1.50	80	18	10.00	8.00	11	3	8.5	34	E500M10NO2	E501M10NO2	
10	1.50	80	18	10.00	8.00	11	3	8.5	34	E500M10NO3	E501M10NO3	E504M10NO3
10	1.50	80	18	10.00	8.00	11	3	8.5	34	E500M10NO6		
10	1.50	80	18	10.00	8.00	11	3	8.5	34	E500M10NO7		
10	1.50	80	18	10.00	8.00	11	3	8.5	34	E500M10NO8		
11	1.50	85	19	8.00	6.30	9	3	9.5	-	E500M11NO1		
11	1.50	85	19	8.00	6.30	9	3	9.5	-	E500M11NO2		
11	1.50	85	19	8.00	6.30	9	3	9.5	-	E500M11NO3		
11	1.50	85	19	8.00	6.30	9	3	9.5	-	E500M11NO6		
12	1.75	89	22	9.00	7.10	10	3	10.3	-	E500M12NO1	E501M12NO1	
12	1.75	89	22	9.00	7.10	10	3	10.3	-	E500M12NO2	E501M12NO2	
12	1.75	89	22	9.00	7.10	10	3	10.3	-	E500M12NO3	E501M12NO3	E504M12NO3
12	1.75	89	22	9.00	7.10	10	3	10.3	-	E500M12NO6		
12	1.75	89	22	9.00	7.10	10	3	10.3	-	E500M12NO7		
12	1.75	89	22	9.00	7.10	10	3	10.3	-	E500M12NO8		
14	2.00	95	24	11.20	9.00	12	4	12	-	E500M14NO1	E501M14NO1	
14	2.00	95	24	11.20	9.00	12	4	12	-	E500M14NO2	E501M14NO2	
14	2.00	95	24	11.20	9.00	12	4	12	-	E500M14NO3	E501M14NO3	
14	2.00	95	24	11.20	9.00	12	4	12	-	E500M14NO6		
14	2.00	95	24	11.20	9.00	12	4	12	-	E500M14NO7		
14	2.00	95	24	11.20	9.00	12	4	12	-	E500M14NO8		
16	2.00	102	24	12.50	10.00	13	4	14	-	E500M16NO1	E501M16NO1	
16	2.00	102	24	12.50	10.00	13	4	14	-	E500M16NO2	E501M16NO2	
16	2.00	102	24	12.50	10.00	13	4	14	-	E500M16NO3	E501M16NO3	E504M16NO3
16	2.00	102	24	12.50	10.00	13	4	14	-	E500M16NO6		
16	2.00	102	24	12.50	10.00	13	4	14	-	E500M16NO7		
16	2.00	102	24	12.50	10.00	13	4	14	-	E500M16NO8		
18	2.50	112	29	14.00	11.20	14	4	15.5	-	E500M18NO1		
18	2.50	112	29	14.00	11.20	14	4	15.5	-	E500M18NO2		
18	2.50	112	29	14.00	11.20	14	4	15.5	-	E500M18NO3	E501M18NO3	
18	2.50	112	29	14.00	11.20	14	4	15.5	-	E500M18NO6		
20	2.50	112	29	14.00	11.20	14	4	17.5	-	E500M20NO1	E501M20NO1	
20	2.50	112	29	14.00	11.20	14	4	17.5	-	E500M20NO2	E501M20NO2	
20	2.50	112	29	14.00	11.20	14	4	17.5	-	E500M20NO3	E501M20NO3	E504M20NO3
20	2.50	112	29	14.00	11.20	14	4	17.5	-	E500M20NO6		
20	2.50	112	29	14.00	11.20	14	4	17.5	-	E500M20NO7		
20	2.50	112	29	14.00	11.20	14	4	17.5	-	E500M20NO8		
22	2.50	118	29	16.00	12.50	16	4	19.5	-	E500M22NO1		
22	2.50	118	29	16.00	12.50	16	4	19.5	-	E500M22NO2		
22	2.50	118	29	16.00	12.50	16	4	19.5	-	E500M22NO3	E501M22NO3	
22	2.50	118	29	16.00	12.50	16	4	19.5	-	E500M22NO6		
24	3.00	130	35	18.00	14.00	18	4	21	-	E500M24NO1		
24	3.00	130	35	18.00	14.00	18	4	21	-	E500M24NO2	E501M24NO2	
24	3.00	130	35	18.00	14.00	18	4	21	-	E500M24NO3	E501M24NO3	E504M24NO3
24	3.00	130	35	18.00	14.00	18	4	21	-	E500M24NO6		
24	3.00	130	35	18.00	14.00	18	4	21	-	E500M24NO7		
27	3.00	135	35	20.00	16.00	20	4	24	-	E500M27NO1		
27	3.00	135	35	20.00	16.00	20	4	24	-	E500M27NO2		
27	3.00	135	35	20.00	16.00	20	4	24	-	E500M27NO3		
30	3.50	138	41	20.00	16.00	20	4	26.5	-	E500M30NO1		
30	3.50	138	41	20.00	16.00	20	4	26.5	-	E500M30NO2		
30	3.50	138	41	20.00	16.00	20	4	26.5	-	E500M30NO3		
33	3.50	151	41	22.40	18.00	22	4	29.5	-	E500M33NO1		
33	3.50	151	41	22.40	18.00	22	4	29.5	-	E500M33NO2		
33	3.50	151	41	22.40	18.00	22	4	29.5	-	E500M33NO3		
36	4.00	162	47	25.00	20.00	24	4	32	-	E500M36NO1		
36	4.00	162	47	25.00	20.00	24	4	32	-	E500M36NO2		
36	4.00	162	47	25.00	20.00	24	4	32	-	E500M36NO3		
39	4.00	170	47	28.00	22.40	26	4	35	-	E500M39NO1		
39	4.00	170	47	28.00	22.40	26	4	35	-	E500M39NO2		
39	4.00	170	47	28.00	22.40	26	4	35	-	E500M39NO3		
42	4.50	170	53	28.00	22.40	26	6	37.5	-	E500M42NO1		
42	4.50	170	53	28.00	22.40	26	6	37.5	-	E500M42NO2		
42	4.50	170	53	28.00	22.40	26	6	37.5	-	E500M42NO3		



M	P mm	l ₁ mm	l ₂ mm	d ₂ ∅ mm	a mm	l ₃ mm	z		l ₄ mm	E500	E501	E504
45	4.50	187	54	31.50	25.00	28	6	40.5	-	E500M45NO1		
45	4.50	187	54	31.50	25.00	28	6	40.5	-	E500M45NO2		
45	4.50	187	54	31.50	25.00	28	6	40.5	-	E500M45NO3		
48	5.00	187	60	31.50	25.00	28	6	43	-	E500M48NO1		
48	5.00	187	60	31.50	25.00	28	6	43	-	E500M48NO2		
48	5.00	187	60	31.50	25.00	28	6	43	-	E500M48NO3		
52	5.00	200	60	35.50	28.00	31	6	47	-	E500M52NO3		
56	5.50	200	60	35.50	28.00	31	6	50.5	-	E500M56NO3		

E303



- M 机用丝锥 直槽
- M Macho Máquina Canal Reto
- M Machos de máquina Estrías rectas
- M Machine Tap Straight Flute

E303

E303 • 1.1 1.2 1.3 1.4 1.5 3.1 3.2 3.3 6.2 6.3 7.2 7.3 8.2

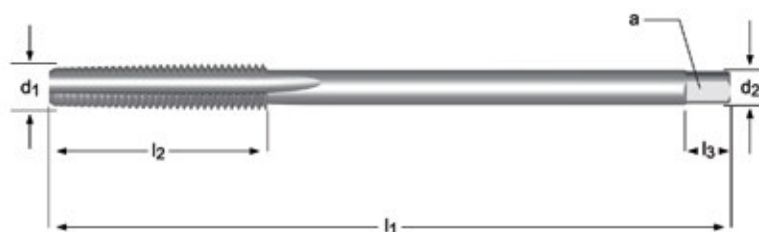

M	P mm	l_1 mm	l_2 mm	d_2 Ø mm	a mm	l_3 mm	z		E303
3	0.50	70	22	2.2	2.1	5	3	2.5	E303M3NO1
3	0.50	70	22	2.2	2.1	5	3	2.5	E303M3NO3
4	0.70	90	25	2.8	2.1	5	3	3.3	E303M4NO1
4	0.70	90	25	2.8	2.1	5	3	3.3	E303M4NO3
5	0.80	100	28	3.5	2.7	6	3	4.2	E303M5NO1
5	0.80	100	28	3.5	2.7	6	3	4.2	E303M5NO3
6	1.00	110	32	4.5	3.4	6	3	5.0	E303M6NO1
6	1.00	110	32	4.5	3.4	6	3	5.0	E303M6NO3
8	1.25	125	40	6.0	4.9	8	3	6.8	E303M8NO1
8	1.25	125	40	6.0	4.9	8	3	6.8	E303M8NO3
10	1.50	140	45	7.0	5.5	8	3	8.5	E303M10NO1
10	1.50	140	45	7.0	5.5	8	3	8.5	E303M10NO3
12	1.75	180	50	9.0	7.0	10	3	10.3	E303M12NO1
12	1.75	180	50	9.0	7.0	10	3	10.3	E303M12NO3
14	2.00	200	56	11.0	9.0	12	3	12.0	E303M14NO1
14	2.00	200	56	11.0	9.0	12	3	12.0	E303M14NO3
16	2.00	200	63	12.0	9.0	12	3	14.0	E303M16NO1
16	2.00	200	63	12.0	9.0	12	3	14.0	E303M16NO3
18	2.50	220	63	14.0	11.0	14	3	15.5	E303M18NO1
18	2.50	220	63	14.0	11.0	14	3	15.5	E303M18NO3
20	2.50	250	70	16.0	12.0	15	3	17.5	E303M20NO1
20	2.50	250	70	16.0	12.0	15	3	17.5	E303M20NO3





- E600**
- M 机用丝锥, 超长, 直槽
 - M Macho Máquina Extra Longo Canal Reto
- E610**
- M Machos de máquina Extra largo Estrías rectas
 - M Machine Tap, Extra Long Straight Flute

E600	•	1.1	1.2	1.3	1.4	1.5	3.1	3.2	3.3	3.4	6.1	6.2	6.3	6.4	7.2	7.3	7.4	8.2	8.3
E610	▪	3.1	3.2	3.3															
	•	1.1	1.2	1.3	1.4	1.5	3.4	6.2	6.3	6.4	7.2	7.3	7.4	8.2	8.3				

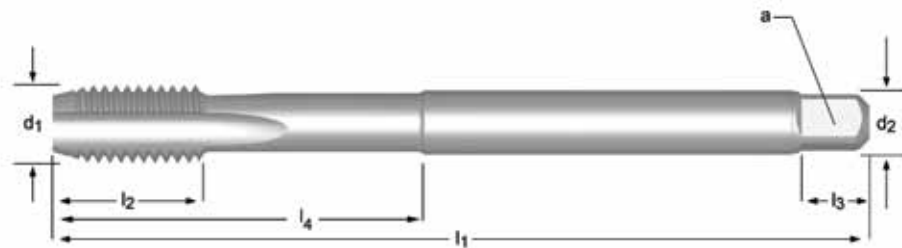

M	P mm	l_1 mm	l_2 mm	d_2 Ø mm	\square a mm	l_3 mm	z		l_4 mm	E600	E610
3	0.50	66	9	3.15	2.50	5	3	2.5	18	E600M3NO3	E610M3NO3
4	0.70	73	12	3.15	2.50	5	3	3.3	-	E600M4NO1	
4	0.70	73	12	3.15	2.50	5	3	3.3	-	E600M4NO2	
4	0.70	73	12	3.15	2.50	5	3	3.3	-	E600M4NO3	E610M4NO3
5	0.80	79	12	4.00	3.15	6	3	4.2	-	E600M5NO1	
5	0.80	79	12	4.00	3.15	6	3	4.2	-	E600M5NO2	
5	0.80	79	12	4.00	3.15	6	3	4.2	-	E600M5NO3	E610M5NO3
6	1.00	89	14	4.50	3.55	6	3	5	-	E600M6NO1	
6	1.00	89	14	4.50	3.55	6	3	5	-	E600M6NO2	
6	1.00	89	14	4.50	3.55	6	3	5	-	E600M6NO3	E610M6NO3
8	1.25	97	17	6.30	5.00	8	3	6.8	-	E600M8NO1	
8	1.25	97	17	6.30	5.00	8	3	6.8	-	E600M8NO2	
8	1.25	97	17	6.30	5.00	8	3	6.8	-	E600M8NO3	E610M8NO3
10	1.50	108	19	8.00	6.30	9	3	8.5	-	E600M10NO1	
10	1.50	108	19	8.00	6.30	9	3	8.5	-	E600M10NO2	
10	1.50	108	19	8.00	6.30	9	3	8.5	-	E600M10NO3	E610M10NO3
12	1.75	119	23	9.00	7.10	10	3	10.3	-	E600M12NO1	
12	1.75	119	23	9.00	7.10	10	3	10.3	-	E600M12NO2	
12	1.75	119	23	9.00	7.10	10	3	10.3	-	E600M12NO3	E610M12NO3
14	2.00	127	25	11.20	9.00	12	4	12	-	E600M14NO3	E610M14NO3
16	2.00	137	25	12.50	10.0	13	4	14	-	E600M16NO3	E610M16NO3
20	2.50	149	30	14.00	11.2	14	4	17.5	-	E600M20NO2	
20	2.50	149	30	14.00	11.2	14	4	17.5	-	E600M20NO3	
24	3.00	172	36	18.00	14.0	18	4	21	-	E600M24NO3	
30	3.50	183	42	20.00	16.0	20	4	26.5	-	E600M30NO3	

EP006H	M	DIN 371≤10 376≥12	6H		2.5XD	HSS-E	B 3.5-5				L114 307
EP006G	M	DIN 371≤10 376≥12	6G		2.5XD	HSS-E	B 3.5-5				
EP00TIN	M	DIN 371≤10 376≥12	6H		2.5XD	HSS-E	B 3.5-5			TIN	
EP016H	M	DIN 371≤10 376≥12	6H		2.5XD	HSS-E	B 3.5-5			ST	

- EP006H** • M 机用螺尖 丝锥
- EP006G** • M Macho Máquina Ponta Helicoidal
- EP00TIN** • M Machos de máquina Entrada en hélice
- EP016H** • M Machine Tap Spiral Point

EP006H; EP006G	■	1.1	1.2	1.3	1.4	1.5	6.1	6.3	7.1	7.2	7.3	7.4	
	●	1.6	3.1	3.2	3.3	3.4	4.1	4.2	5.1	5.2	6.2	8.1	
EP00TIN	■	1.1	1.2	1.3	1.4	1.5	2.1	2.2	6.1	6.3	7.3	7.4	
	●	1.6	2.3	3.1	3.2	3.3	3.4	4.1	4.2	5.1	5.2	6.2	8.2
EP016H	■	1.1	1.2	1.3	1.4	1.5							
	●	1.6	2.1	2.2	2.3	3.1	3.2	3.3	3.4				

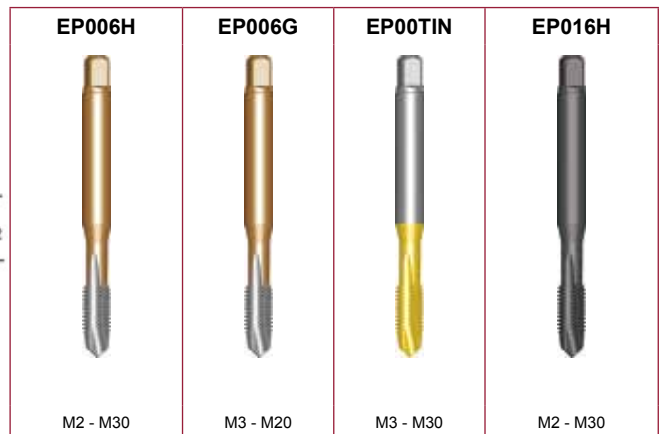
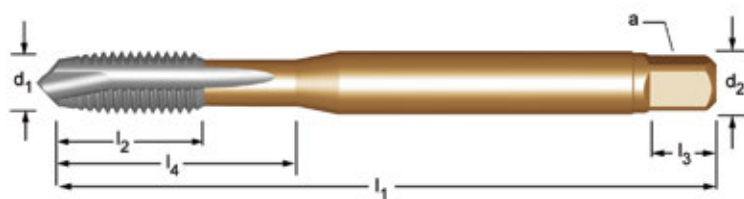

M	P mm	l ₁ mm	l ₂ mm	d ₂ mm	a mm	l ₃ mm	z	l ₄ mm	EP006H	EP006G	EP00TIN	EP016H	
2	0.40	50	6	2.8	2.1	5	2	1.6	9	EP00M2		EP01M2	
2.5	0.45	50	8	2.8	2.1	5	2	2.1	12.5	EP00M2.5		EP01M2.5	
3	0.50	56	10	2.2	1.8	4	3	2.5	18	EP00M3DIN376		EP01M3DIN376	
3	0.50	56	9	3.5	2.7	6	3	2.5	18	EP00M3	EP006GM3	EP00TINM3	EP01M3
3.5	0.60	56	11	4.0	3.0	6	3	2.9	20	EP00M3.5		EP01M3.5	
4	0.70	63	12	2.8	2.1	5	3	3.3	21	EP00M4DIN376		EP01M4DIN376	
4	0.70	63	12	4.5	3.4	6	3	3.3	21	EP00M4	EP006GM4	EP00TINM4	EP01M4
4.5	0.75	70	13	6.0	4.9	8	3	3.8	25	EP00M4.5		EP01M4.5	
5	0.80	70	13	3.5	2.7	6	3	4.2	25	EP00M5DIN376		EP01M5DIN376	
5	0.80	70	13	6.0	4.9	8	3	4.2	25	EP00M5	EP006GM5	EP00TINM5	EP01M5
6	1.00	80	15	4.5	3.4	6	3	5	30	EP00M6DIN376		EP01M6DIN376	
6	1.00	80	15	6.0	4.9	8	3	5	30	EP00M6	EP006GM6	EP00TINM6	EP01M6
7	1.00	80	15	7.0	5.5	8	3	6	30	EP00M7		EP01M7	
8	1.25	90	18	6.0	4.9	8	3	6.8	35	EP00M8DIN376		EP01M8DIN376	

M	P mm	l ₁ mm	l ₂ mm	d ₂ Ø mm	□ a mm	l ₃ mm	z	 mm	l ₄ mm	EP006H	EP006G	EP00TIN	EP016H
8	1.25	90	18	8.0	6.2	9	3	6.8	35	EP00M8	EP006GM8	EP00TINM8	EP01M8
10	1.50	100	20	10.0	8.0	11	3	8.5	39	EP00M10	EP006GM10	EP00TINM10	EP01M10
10	1.50	100	20	7.0	5.5	8	3	8.5	-	EP00M10DIN376			EP01M10DIN376
12	1.75	110	23	9.0	7.0	10	3	10.3	-	EP00M12	EP006GM12	EP00TINM12	EP01M12
14	2.00	110	25	11.0	9.0	12	3	12	-	EP00M14		EP00TINM14	EP01M14
16	2.00	110	25	12.0	9.0	12	3	14	-	EP00M16	EP006GM16	EP00TINM16	EP01M16
18	2.50	125	30	14.0	11.0	14	4	15.5	-	EP00M18		EP00TINM18	EP01M18
20	2.50	140	30	16.0	12.0	15	4	17.5	-	EP00M20	EP006GM20	EP00TINM20	EP01M20
22	2.50	140	34	18.0	14.5	17	4	19.5	-	EP00M22		EP00TINM22	EP01M22
24	3.00	160	38	18.0	14.5	17	4	21	-	EP00M24		EP00TINM24	EP01M24
27	3.00	160	38	20.0	16.0	19	4	24	-	EP00M27		EP00TINM27	EP01M27
30	3.50	180	45	22.0	18.0	21	4	26.5	-	EP00M30		EP00TINM30	EP01M30

E297

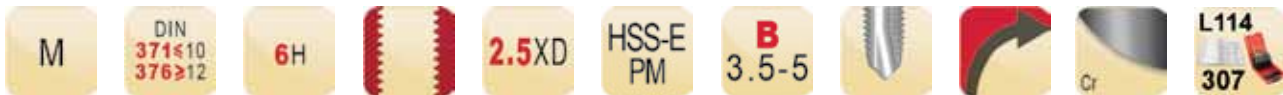

E297

- M 机用螺尖丝锥，黄圈鲨鱼丝锥
- M Macho Máquina Ponta Helicoidal, Shark - Anel Amarelo
- M Macho de máquina con entrada en hélice Shark (Anillo Amarillo)
- M Machine Tap Spiral Point, Yellow Shark

提供HSS-E，直到新的可用库存

Fornecido em HSS-E até disponibilidade do novo estoque

Suministrado en HSS-E hasta disponibilidad de nuevo stock

Supplied in HSS-E until new stock available

E297 ■ 1.1 1.2 1.3 6.1 6.3
 • 1.4 1.5 6.2



M	P mm	l ₁ mm	l ₂ mm	d ₂ Ø mm	∠ a mm	l ₃ mm	z		l ₄ mm	E297
3	0.50	56	9	3.5	2.7	6	3	2.5	18	E297M3
4	0.70	63	12	4.5	3.4	6	3	3.3	21	E297M4
5	0.80	70	13	6.0	4.9	8	3	4.2	25	E297M5
6	1.00	80	15	6.0	4.9	8	3	5.0	30	E297M6
8	1.25	90	18	8.0	6.2	9	3	6.8	35	E297M8
10	1.50	100	20	10.0	8.0	11	3	8.5	39	E297M10
12	1.75	110	23	9.0	7.0	10	3	10.3	-	E297M12
14	2.00	110	25	11.0	9.0	12	3	12.0	-	E297M14
16	2.00	110	25	12.0	9.0	12	3	14.0	-	E297M16
18	2.50	125	30	14.0	11.0	14	3	15.5	-	E297M18
20	2.50	140	30	16.0	12.0	15	3	17.5	-	E297M20
22	2.50	140	34	18.0	14.5	17	4	19.5	-	E297M22
24	3.00	160	38	18.0	14.5	17	4	21.0	-	E297M24
27	3.00	160	38	20.0	16.0	19	4	24.0	-	E297M27
30	3.50	180	45	22.0	18.0	21	4	26.5	-	E297M30



- E255**
- M 机用螺尖丝锥，红圈鲨鱼丝锥
 - M Macho Máquina Ponta Helicoidal, Shark - Anel Vermelho
- E256**
- M Macho de máquina con entrada en hélice Shark (Anillo Rojo)
 - M Machine Tap Spiral Point, Red Shark

E255	▪	1.4			
	•	1.5	1.6	4.2	5.2
E256	▪	1.4	1.5		
	•	1.6	4.2	5.2	

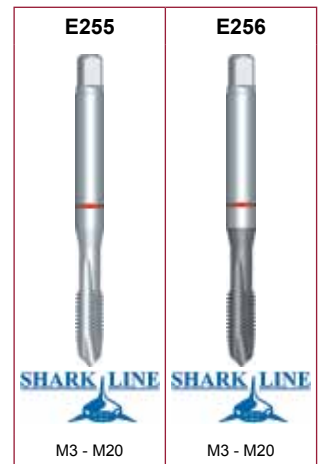
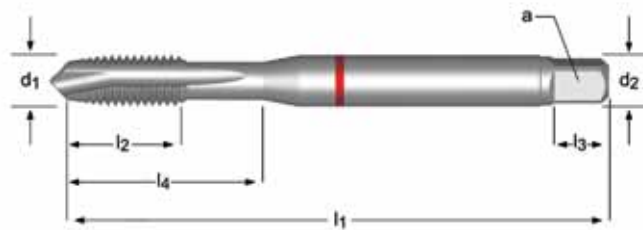

M	P mm	l ₁ mm	l ₂ mm	d ₂ Ø mm	∠ a mm	l ₃ mm	z		l ₄ mm	E255	E256
3	0.50	56	9	3.5	2.7	6	3	2.5	18	E255M3	E256M3
4	0.70	63	12	4.5	3.4	6	3	3.3	21	E255M4	E256M4
5	0.80	70	13	6.0	4.9	8	3	4.2	25	E255M5	E256M5
6	1.00	80	15	6.0	4.9	8	3	5.0	30	E255M6	E256M6
8	1.25	90	18	8.0	6.2	9	3	6.8	35	E255M8	E256M8
10	1.50	100	20	10.0	8.0	11	3	8.5	39	E255M10	E256M10
12	1.75	110	23	9.0	7.0	10	3	10.3	-	E255M12	E256M12
14	2.00	110	25	11.0	9.0	12	3	12.0	-	E255M14	
16	2.00	110	25	12.0	9.0	12	3	14.0	-	E255M16	E256M16
20	2.50	140	30	16.0	12.0	15	4	17.5	-	E255M20	E256M20



- E240**
- M 机用螺尖丝锥，蓝圈鲨鱼丝锥
 - M Macho Máquina Ponta Helicoidal Shark - Anel Azul
- E241**
- M Macho de máquina con entrada en hélice Shark (Anillo Azul)
 - M Machine Tap Spiral Point, Blue Shark

提供HSS-E，直到新的可用库存
 Fornecido em HSS-E até disponibilidade do novo estoque
 Suministrado en HSS-E hasta disponibilidad de nuevo stock
 Supplied in HSS-E until new stock available

E240	▪	2.1	2.2	2.3
	•	1.5	1.6	
E241	▪	2.1	2.2	2.3
	•	1.3	1.4	1.5

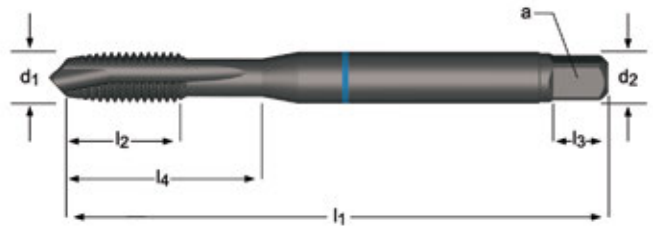

M	P mm	l ₁ mm	l ₂ mm	d ₂ Ø mm	□ a mm	l ₃ mm	z	↔	l ₄ mm	E240	E241
3	0.50	56	9	3.5	2.7	6	3	2.5	18	E240M3	E241M3
4	0.70	63	12	4.5	3.4	6	3	3.3	21	E240M4	E241M4
5	0.80	70	13	6.0	4.9	8	3	4.2	25	E240M5	E241M5
6	1.00	80	15	6.0	4.9	8	3	5.0	30	E240M6	E241M6
8	1.25	90	18	8.0	6.2	9	3	6.8	35	E240M8	E241M8
10	1.50	100	20	10.0	8.0	11	3	8.5	39	E240M10	E241M10
12	1.75	110	23	9.0	7.0	10	4	10.3	-	E240M12	E241M12
14	2.00	110	25	11.0	9.0	12	4	12.0	-	E240M14	E241M14
16	2.00	110	25	12.0	9.0	12	4	14.0	-	E240M16	E241M16
18	2.50	125	30	14.0	11.0	14	4	15.5	-	E240M18	E241M18
20	2.50	140	30	16.0	12.0	15	4	17.5	-	E240M20	E241M20
22	2.50	140	34	18.0	14.5	17	4	19.5	-	E240M22	
24	3.00	160	38	18.0	14.5	17	4	21.0	-	E240M24	
27	3.00	160	38	20.0	16.0	19	4	24.0	-	E240M27	
30	3.50	180	45	22.0	18.0	21	4	26.5	-	E240M30	



- E471**
- M机用螺尖丝锥，绿圈鲨鱼丝锥
 - M Macho Máquina Ponta Helicoidal, Shark - Anel Verde
- E472**
- M Macho de máquina con entrada en hélice Shark (Anillo Verde)
 - M Machine Tap Spiral Point, Green Shark

E471	▪	6.2	6.3	7.1	7.2	7.3	8.1
	•	1.1	1.2	1.3	6.1	7.4	
E472	▪	4.1	5.1	6.2	7.2	7.3	7.4
	•	1.2	1.3	6.3	7.1	8.1	

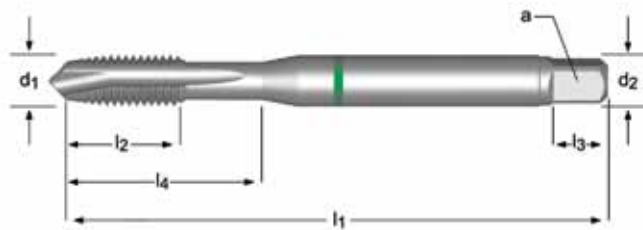

M	P mm	l ₁ mm	l ₂ mm	d ₂ ∅ mm	a mm	l ₃ mm	z	↔	l ₄ mm	E471	E472
3	0.50	56	9	3.5	2.7	6	2	2.5	18	E471M3	E472M3
4	0.70	63	12	4.5	3.4	6	2	3.3	21	E471M4	E472M4
5	0.80	70	13	6.0	4.9	8	2	4.2	25	E471M5	E472M5
6	1.00	80	15	6.0	4.9	8	3	5.0	30	E471M6	E472M6
8	1.25	90	18	8.0	6.2	9	3	6.8	35	E471M8	E472M8
10	1.50	100	20	10.0	8.0	11	3	8.5	39	E471M10	E472M10
12	1.75	110	23	9.0	7.0	10	3	10.3	-	E471M12	E472M12
16	2.00	110	25	12.0	9.0	12	4	14.0	-	E471M16	E472M16
20	2.50	140	30	16.0	12.0	15	4	17.5	-	E471M20	E472M20



E000

- M 机用螺尖 丝锥

E000TIN

- M Macho Máquina Ponta Helicoidal

E001

- M Machos de máquina Entrada en hélice

- M Machine Tap Spiral Point

E000	■	1.1	1.2	1.3	1.4	1.5	6.1	6.3	7.1	7.2	7.3	7.4
	•	1.6	3.1	3.2	3.3	3.4	4.1	4.2	5.1	5.2	6.2	8.1
E000TIN	■	1.1	1.2	1.3	1.4	1.5	2.1	2.2	6.1	6.3	7.3	7.4
	•	1.6	2.3	3.1	3.2	3.3	3.4	4.1	4.2	5.1	5.2	6.2
E001	■	1.1	1.2	1.3	1.4	1.5						
	•	1.6	2.1	2.2	2.3	3.1	3.2	3.3	3.4			

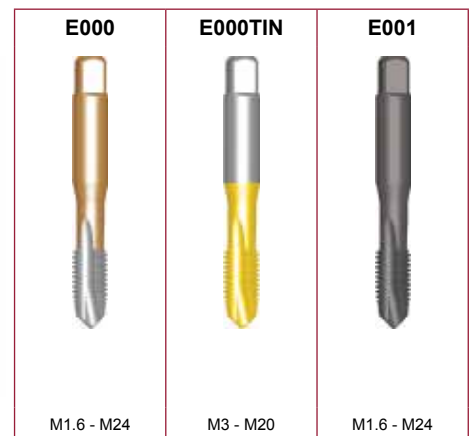
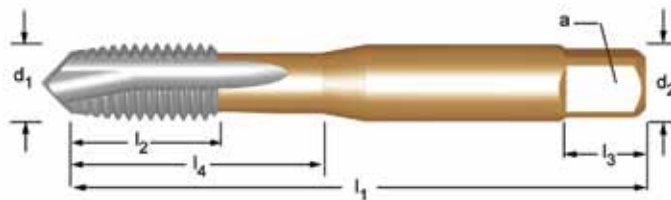

M	P	l ₁	l ₂	d ₂	□	l ₃	z		l ₄	E000	E000TIN	E001
mm	mm	mm	mm	mm	mm	mm			mm			
1.6	0.35	41	7	2.50	2.00	4	2	1.25	7	E000M1.6		E001M1.6
2	0.40	41	8	2.50	2.00	4	2	1.6	8	E000M2		E001M2
2.5	0.45	44.5	9.5	2.80	2.24	5	2	2.05	9.5	E000M2.5		E001M2.5
3	0.50	48	15	3.15	2.50	5	3	2.5	15	E000M3	E000TINM3	E001M3
3.5	0.60	50	16	3.55	2.80	5	3	2.9	16	E000M3.5		E001M3.5
4	0.70	53	17	4.00	3.15	6	3	3.3	17	E000M4	E000TINM4	E001M4
5	0.80	58	11	5.00	4.00	7	3	4.2	22	E000M5	E000TINM5	E001M5
6	1.00	66	13	6.30	5.00	8	3	5.0	26	E000M6	E000TINM6	E001M6
7	1.00	66	13	7.10	5.60	8	3	6.0	26	E000M7		E001M7
8	1.25	72	16	8.00	6.30	9	3	6.8	29	E000M8	E000TINM8	E001M8
10	1.50	80	18	10.00	8.00	11	3	8.5	34	E000M10	E000TINM10	E001M10
12	1.75	89	22	9.00	7.10	10	3	10.3	-	E000M12	E000TINM12	E001M12
14	2.00	95	24	11.20	9.00	12	3	12.0	-	E000M14		E001M14
16	2.00	102	24	12.50	10.00	13	3	14.0	-	E000M16	E000TINM16	E001M16
18	2.50	112	29	14.00	11.20	14	4	15.5	-	E000M18		E001M18
20	2.50	112	29	14.00	11.20	14	4	17.5	-	E000M20	E000TINM20	E001M20
22	2.50	118	29	16.00	12.50	16	4	19.5	-	E000M22		E001M22
24	3.00	130	35	18.00	14.00	18	4	21.0	-	E000M24		E001M24

E510



- M 机用螺尖 丝锥
- M Macho Máquina Ponta Helicoidal
- M Machos de máquina Entrada en hélice
- M Machine Tap Spiral Point

E510

E510 ■ 1.5 1.6 2.1 2.2 2.3 3.1 3.2 3.3

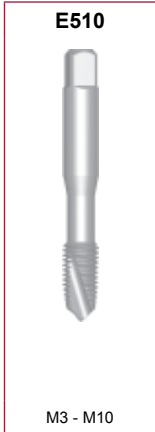
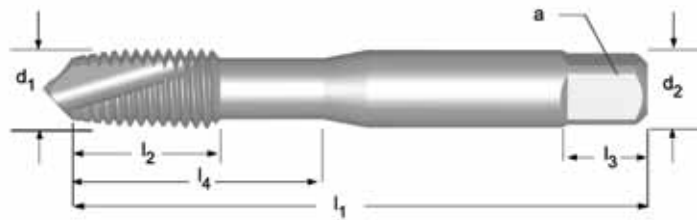

M	P mm	l_1 mm	l_2 mm	d_2 \varnothing mm	\square a mm	l_3 mm	z		l_4 mm	E510
3	0.50	48	12.5	3.15	2.50	5	2	2.5	12.5	E510M3
4	0.70	53	14	4.00	3.15	6	2	3.3	14	E510M4
5	0.80	58	11	5.00	4.00	7	2	4.2	22	E510M5
6	1.00	66	13	6.30	5.00	8	3	5	26	E510M6
8	1.25	72	16	8.00	6.30	9	3	6.8	29	E510M8
10	1.50	80	18	10.00	8.00	11	3	8.5	34	E510M10

E606

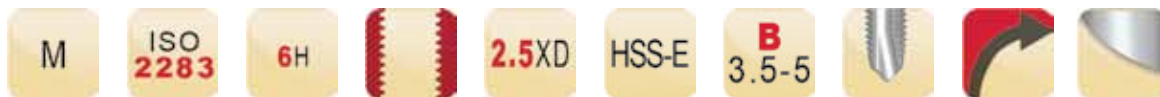

- M 机用丝锥, 超长, 螺尖
- M Macho Máquina Extra Longo Ponta Helicoidal
- M Machos de máquina Extra largo Entrada en hélice
- M Machine Tap, Extra Long Spiral Point

E606

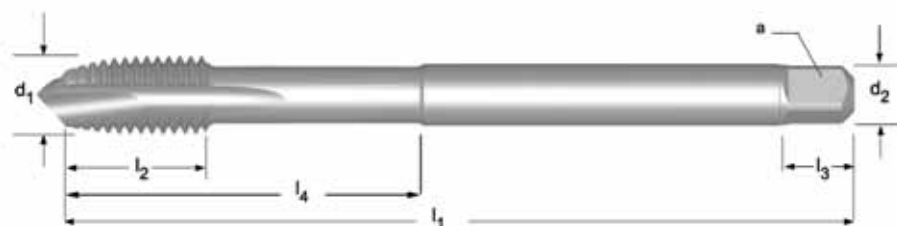

M	P mm	l_1 mm	l_2 mm	d_2 Ø mm	a mm	l_3 mm	z		l_4 mm	E606
3	0.50	66	9	3.15	2.50	5	3	2.5	18	E606M3
4	0.70	73	12	3.15	2.50	5	3	3.3	-	E606M4
5	0.80	79	12	4.00	3.15	6	3	4.2	-	E606M5
6	1.00	89	14	4.50	3.55	6	3	5	-	E606M6
8	1.25	97	17	6.30	5.00	8	3	6.8	-	E606M8
10	1.50	108	19	8.00	6.30	9	3	8.5	-	E606M10
12	1.75	119	23	9.00	7.10	10	3	10.3	-	E606M12
14	2.00	127	25	11.20	9.00	12	3	12	-	E606M14
16	2.00	137	25	12.50	10.00	13	3	14	-	E606M16
20	2.50	149	30	14.00	11.20	14	4	17.5	-	E606M20
24	3.00	172	36	18.00	14.00	18	4	21	-	E606M24



- E216** • M 跳牙机用丝锥 螺尖
- E266** • M Macho Máquina, Rosca Interrompida Ponta Helicoidal
- E422** • M Machos de máquina, dientes alternos Entrada en hélice
- E423** • M Machine Tap, Interrupted Threads Spiral Point

E216; E266; E422; E423	■	1.2	1.3	1.4														
	●	1.1	1.5	3.1	3.2	3.3	3.4	4.1	4.3	5.1	5.2	6.1	6.2	6.3	7.1	7.2		
		7.3	7.4	8.1														

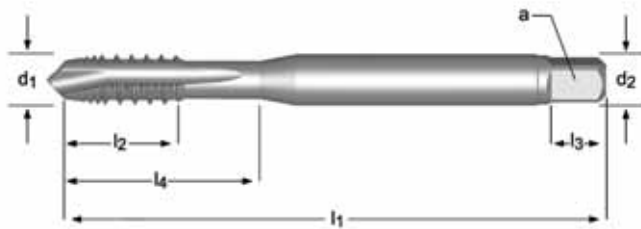

M	P mm	l ₁ mm	l ₂ mm	d ₂ Ø mm	□ a mm	l ₃ mm	z	↔ mm	l ₄ mm	E216	E266	E422	E423
3	0.50	56	9	3.5	2.7	6	3	2.5	18	E216M3		E422M3	
4	0.70	63	12	4.5	3.4	6	3	3.3	21	E216M4		E422M4	
5	0.80	70	13	6.0	4.9	8	3	4.2	25	E216M5		E422M5	
6	1.00	80	15	6.0	4.9	8	3	5.0	30	E216M6		E422M6	
8	1.25	90	18	8.0	6.2	9	3	6.8	35	E216M8		E422M8	
10	1.50	100	20	10.0	8.0	11	3	8.5	39	E216M10		E422M10	
12	1.75	110	23	9.0	7.0	10	3	10.3			E266M12		E423M12
14	2.00	110	25	11.0	9.0	12	3	12.0			E266M14		E423M14
16	2.00	110	25	12.0	9.0	12	3	14.0			E266M16		E423M16
18	2.50	125	30	14.0	11.0	14	3	15.5			E266M18		E423M18
20	2.50	140	30	16.0	12.0	15	3	17.5			E266M20		E423M20
22	2.50	140	34	18.0	14.5	17	4	19.5			E266M22		E423M22
24	3.00	160	38	18.0	14.5	17	4	21.0			E266M24		E423M24

E207	M	DIN 371	6H		1.5XD	HSS-E	C 2-3			
E258	M	DIN 376	6H		1.5XD	HSS-E	C 2-3			
E212	M	DIN 371	6H		1.5XD	HSS-E	C 2-3			
E263	M	DIN 376	6H		1.5XD	HSS-E	C 2-3			

- E207** • M 机用丝锥 螺旋槽 15°
- E258** • M Macho Máquina Canal Helicoidal 15°
- E212** • M Machos de máquina Estrías helicoidales a 15°
- E263** • M Machine Tap Spiral Flute 15°

E207; E258	▪	1.3	1.4				
	•	1.2	1.5	7.2	7.3		
E212; E263	▪	1.3	1.4				
	•	1.1	1.2	1.5	4.2	4.3	7.2

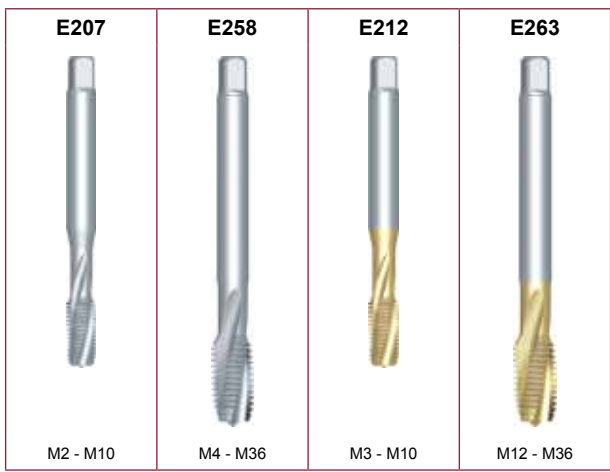
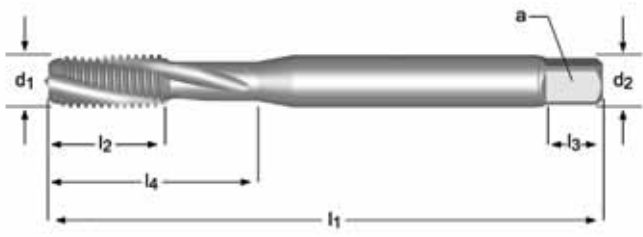

M	P mm	l ₁ mm	l ₂ mm	d ₂ ∅ mm	a mm	l ₃ mm	z		l ₄ mm	E207	E258	E212	E263
2	0.40	45	4	2.8	2.1	5	3	1.6	9	E207M2			
2.5	0.45	50	4	2.8	2.1	5	3	2.05	12.5	E207M2.5			
3	0.50	56	9	3.5	2.7	6	3	2.5	18	E207M3		E212M3	
3.5	0.60	56	11	4.0	3.0	6	3	2.9	20	E207M3.5			
4	0.70	63	12	4.5	3.4	6	3	3.3	21	E207M4		E212M4	
4	0.70	63	12	2.8	2.1	5	3	3.3	-		E258M4		
5	0.80	70	13	3.5	2.7	6	3	4.2	-		E258M5		
5	0.80	70	13	6.0	4.9	8	3	4.2	25	E207M5		E212M5	
6	1.00	80	15	4.5	3.4	6	3	5.0	-		E258M6		
6	1.00	80	15	6.0	4.9	8	3	5	30	E207M6		E212M6	
7	1.00	80	15	7.0	5.5	8	3	6	30	E207M7			
8	1.25	90	18	6.0	4.9	8	3	6.8	-		E258M8		
8	1.25	90	18	8.0	6.2	9	3	6.8	35	E207M8		E212M8	
10	1.50	100	20	10.0	8.0	11	3	8.5	39	E207M10		E212M10	
10	1.50	100	20	7.0	5.5	8	3	8.5	-		E258M10		
12	1.75	110	23	9.0	7.0	10	3	10.3	-		E258M12		E263M12

M	P mm	l ₁ mm	l ₂ mm	d ₂ ∅ mm	□ a mm	l ₃ mm	z	 mm	l ₄ mm	E207	E258	E212	E263
14	2.00	110	25	11.0	9.0	12	3	12.0	-		E258M14		E263M14
16	2.00	110	25	12.0	9.0	12	3	14.0	-		E258M16		E263M16
18	2.50	125	30	14.0	11.0	14	3	15.5	-		E258M18		E263M18
20	2.50	140	30	16.0	12.0	15	3	17.5	-		E258M20		E263M20
22	2.50	140	34	18.0	14.5	17	4	19.5	-		E258M22		E263M22
24	3.00	160	38	18.0	14.5	17	4	21.0	-		E258M24		E263M24
27	3.00	160	38	20.0	16.0	19	4	24.0	-		E258M27		E263M27
30	3.50	180	45	22.0	18.0	21	4	26.5	-		E258M30		E263M30
33	3.50	180	50	25.0	20.0	23	4	29.5	-		E258M33		E263M33
36	4.00	200	55	28.0	22.0	25	4	32.0	-		E258M36		E263M36

E052



- M 机用丝锥 螺旋槽 15°
- M Macho Máquina Canal Helicoidal 15°
- M Machos de máquina Estrías helicoidales a 15°
- M Machine Tap Spiral Flute 15°

E052

E052	■	1.4	1.5	6.2	6.3	7.2	7.3	7.4
	•	1.1	1.2	1.3	6.1	7.1		

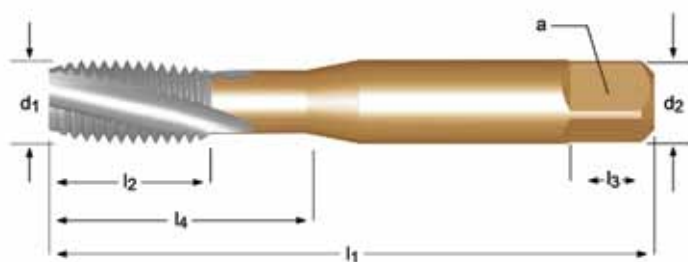

M	P mm	l ₁ mm	l ₂ mm	d ₂ ∅ mm	∠ a mm	l ₃ mm	z		l ₄ mm	E052
3	0.50	48	12.5	3.15	2.50	5	3	2.5	12.5	E052M3
4	0.70	53	14	4.00	3.15	6	3	3.3	14	E052M4
5	0.80	58	11	5.00	4.00	7	3	4.2	22	E052M5
6	1.00	66	13	6.30	5.00	8	3	5	26	E052M6
8	1.25	72	16	8.00	6.30	9	3	6.8	29	E052M8
10	1.50	80	18	10.00	8.00	11	3	8.5	34	E052M10
12	1.75	89	22	9.00	7.10	10	3	10.3	-	E052M12
16	2.00	102	24	12.50	10.00	13	4	14	-	E052M16

EX006H	M	DIN 371 \leq 10 376 \geq 12	6H		2.5XD	HSS-E	C 2-3	$\lambda 45^\circ$			L114 307
EX006G	M	DIN 371 \leq 10 376 \geq 12	6G		2.5XD	HSS-E	C 2-3	$\lambda 45^\circ$			
EX00TIN	M	DIN 371 \leq 10 376 \geq 12	6H		2.5XD	HSS-E	C 2-3	$\lambda 45^\circ$		TIN	
EX016H	M	DIN 371 \leq 10 376 \geq 12	6H		2.5XD	HSS-E	C 2-3	$\lambda 45^\circ$		ST	

- EX006H** • M 机用丝锥 螺旋槽 45°
- EX006G** • M Macho Máquina Canal Helicoidal 45°
- EX00TIN** • M Machos de máquina Estrías helicoidales a 45°
- EX016H** • M Machine Tap Spiral Flute 45°

EX006H; EX006G	▪	1.1	1.2	1.3	1.4	1.5	7.1	7.2	7.3	7.4
	•	4.1	4.2	5.1	5.2					
EX00TIN	▪	1.1	1.2	1.3	1.4	1.5	2.1	2.2	7.3	7.4
	•	2.3	3.1	3.2	3.3	3.4	4.1	4.2	5.1	5.2
EX016H	▪	1.1	1.2	1.3	1.4	1.5	2.1	2.2		
	•	2.3								

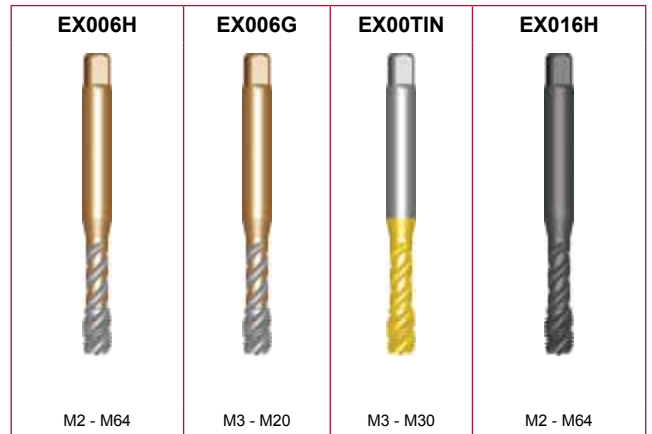
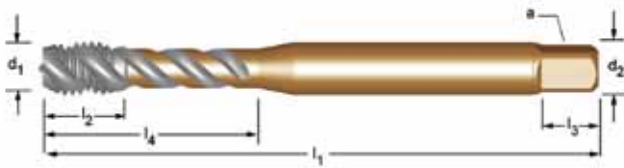

M	P mm	l_1 mm	l_2 mm	d_2 \varnothing mm	\square a mm	l_3 mm	z	\leftrightarrow	l_4 mm	EX006H	EX006G	EX00TIN	EX016H
2	0.40	45	4	2.8	2.1	5	3	1.6	9	EX00M2			EX01M2
2.5	0.45	50	4	2.8	2.1	5	3	2.05	12.5	EX00M2.5			EX01M2.5
3	0.50	56	6	3.5	2.7	6	3	2.5	18	EX00M3	EX00M36G	EX00TINM3	EX01M3
3.5	0.60	56	7	4.0	3.0	6	3	2.9	20	EX00M3.5			EX01M3.5
4	0.70	63	7	4.5	3.4	6	3	3.3	21	EX00M4	EX00M46G	EX00TINM4	EX01M4
5	0.80	70	8	6.0	4.9	8	3	4.2	25	EX00M5	EX00M56G	EX00TINM5	EX01M5
6	1.00	80	10	4.5	3.4	6	3	5	31	EX00M6DIN376			EX01M6DIN376
6	1.00	80	10	6.0	4.9	8	3	5	31	EX00M6	EX00M66G	EX00TINM6	EX01M6
7	1.00	80	10	7.0	5.5	8	3	6	31	EX00M7			EX01M7
8	1.25	90	12	8.0	6.2	9	3	6.8	35	EX00M8	EX00M86G	EX00TINM8	EX01M8
8	1.25	90	13	6.0	4.9	8	3	6.8	35	EX00M8DIN376			EX01M8DIN376
10	1.50	100	15	10.0	8.0	11	3	8.5	39	EX00M10	EX00M106G	EX00TINM10	EX01M10
10	1.50	100	15	7.0	5.5	8	3	8.5	39	EX00M10DIN376			EX01M10DIN376
12	1.75	110	16	9.0	7.0	10	3	10.3	-	EX00M12	EX00M126G	EX00TINM12	EX01M12

M	P mm	l ₁ mm	l ₂ mm	d ₂ Ø mm	a mm	l ₃ mm	z		l ₄ mm	EX006H	EX006G	EX00TIN	EX016H
14	2.00	110	20	11.0	9.0	12	3	12	-	EX00M14	EX00M146G	EX00TINM14	EX01M14
16	2.00	110	20	12.0	9.0	12	4	14	-	EX00M16	EX00M166G	EX00TINM16	EX01M16
18	2.50	125	25	14.0	11.0	14	4	15.5	-	EX00M18		EX00TINM18	EX01M18
20	2.50	140	25	16.0	12.0	15	4	17.5	-	EX00M20	EX00M206G	EX00TINM20	EX01M20
22	2.50	140	25	18.0	14.5	17	4	19.5	-	EX00M22		EX00TINM22	EX01M22
24	3.00	160	30	18.0	14.5	17	4	21	-	EX00M24		EX00TINM24	EX01M24
27	3.00	160	30	20.0	16.0	19	4	24	-	EX00M27		EX00TINM27	EX01M27
30	3.50	180	36	22.0	18.0	21	4	26.5	-	EX00M30		EX00TINM30	EX01M30
33	3.50	180	36	25.0	20.0	23	4	29.5	-	EX00M33			EX01M33
36	4.00	200	40	28.0	22.0	25	4	32	-	EX00M36			EX01M36
39	4.00	200	40	32.0	24.0	27	4	35	-	EX00M39			EX01M39
42	4.50	200	45	32.0	24.0	27	4	37.5	-	EX00M42			EX01M42
48	5.00	250	50	36.0	29.0	32	4	43	-	EX00M48			EX01M48
52	5.00	250	50	40.0	32.0	35	5	47	-	EX00M52			EX01M52
56	5.50	250	55	40.0	32.0	35	5	50.5	-	EX00M56			EX01M56
64	6.00	315	60	50.0	39.0	42	6	58	-	EX00M64			EX01M64

E298



E298

- M 机用螺旋槽40°丝锥，黄圈鲨鱼丝锥
- M Macho Máquina Canal Helicoidal 40°, Shark - Anel Amarelo
- M Macho de máquina helicoidal 40° Shark (Anillo Amarillo)
- M Machine Tap Spiral Flute 40°, Yellow Shark

提供HSS-E，直到新的可用库存

Fornecido em HSS-E até disponibilidade do novo estoque
 Suministrado en HSS-E hasta disponibilidad de nuevo stock
 Supplied in HSS-E until new stock available

E298	■	1.1	1.2	1.3	6.1	6.3
	•	1.4	1.5	6.2		

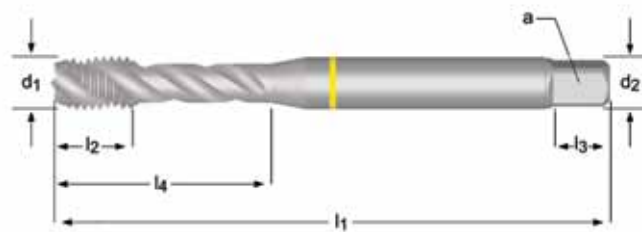

M	P mm	l_1 mm	l_2 mm	d_2 \varnothing mm	\square a mm	l_3 mm	z		l_4 mm	E298
3	0.50	56	6	3.5	2.7	6	3	2.5	18	E298M3
4	0.70	63	7	4.5	3.4	6	3	3.3	21	E298M4
5	0.80	70	8	6.0	4.9	8	3	4.2	25	E298M5
6	1.00	80	10	6.0	4.9	8	3	5.0	30	E298M6
8	1.25	90	13	8.0	6.2	9	3	6.8	35	E298M8
10	1.50	100	15	10.0	8.0	11	3	8.5	39	E298M10
12	1.75	110	18	9.0	7.0	10	3	10.3	-	E298M12
14	2.00	110	20	11.0	9.0	12	3	12.0	-	E298M14
16	2.00	110	20	12.0	9.0	12	4	14.0	-	E298M16
18	2.50	125	25	14.0	11.0	14	4	15.5	-	E298M18
20	2.50	140	25	16.0	12.0	15	4	17.5	-	E298M20
22	2.50	140	25	18.0	14.5	17	4	19.5	-	E298M22
24	3.00	160	30	18.0	14.5	17	4	21.0	-	E298M24
27	3.00	160	30	20.0	16.0	19	4	24.0	-	E298M27
30	3.50	160	36	22.0	18.0	21	4	26.5	-	E298M30



- E260**
- M 机用螺旋槽45°丝锥，带倒锥的红圈鲨鱼丝锥
 - M Macho Máquina Canal Helicoidal 45° Shark - Anel Vermelho, Redução na saída
- E261**
- M Macho de máquina helicoidal 45° Shark con chaflán de salida (Anillo Rojo)
 - M Machine Tap Spiral Flute 45°, Back Tapered, Red Shark

E260	▪	1.4			
	•	1.5	1.6	4.2	5.2
E261	▪	1.4	1.5		
	•	1.6	4.2	5.2	

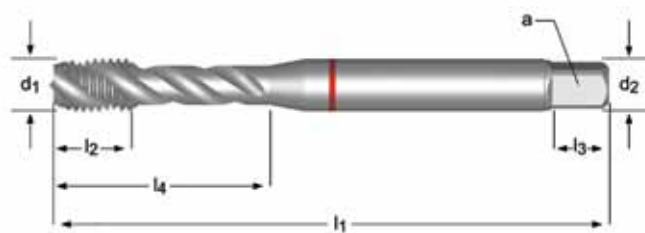

M	P mm	l ₁ mm	l ₂ mm	d ₂ ∅ mm	a mm	l ₃ mm	z		l ₄ mm	E260	E261
3	0.50	56	9	3.5	2.7	6	3	2.5	18	E260M3	E261M3
4	0.70	63	12	4.5	3.4	6	3	3.3	21	E260M4	E261M4
5	0.80	70	13	6.0	4.9	8	3	4.2	25	E260M5	E261M5
6	1.00	80	15	6.0	4.9	8	3	5.0	30	E260M6	E261M6
8	1.25	90	18	8.0	6.2	9	3	6.8	35	E260M8	E261M8
10	1.50	100	20	10.0	8.0	11	3	8.5	39	E260M10	E261M10
12	1.75	110	23	9.0	7.0	10	3	10.3	-	E260M12	E261M12
14	2.00	110	25	11.0	9.0	12	3	12.0	-	E260M14	-
16	2.00	110	25	12.0	9.0	12	4	14.0	-	E260M16	E261M16
20	2.50	140	30	16.0	12.0	15	4	17.5	-	E260M20	E261M20

E238	M	DIN 371≤10 376>12	6H		2.5XD	HSS-E PM	C 2-3			L114 307
E239	M	DIN 371≤10 376>12	6H		2.5XD	HSS-E PM	C 2-3			

- E238**
- M 机用螺旋槽40°丝锥，带倒锥的蓝圈鲨鱼丝锥
 - M Macho Máquina Canal Helicoidal 40° Shark - Anel Azul, Redução na Saída
- E239**
- M Macho de máquina helicoidal 40° Shark con chafán de salida (Anillo Azul)
 - M Machine Tap Spiral Flute 40°, Back Tapered, Blue Shark

E238	▪	2.1	2.2	2.3
	•	1.5	1.6	
E239	▪	2.1	2.2	2.3
	•	1.3	1.4	1.5



M	P mm	l ₁ mm	l ₂ mm	d ₂ ∅ mm	a mm	l ₃ mm	z		l ₄ mm	E238	E239
3	0.50	56	6	3.5	2.7	6	3	2.5	18	E238M3	E239M3
4	0.70	63	7	4.5	3.4	6	3	3.3	21	E238M4	E239M4
5	0.80	70	8	6.0	4.9	8	3	4.2	25	E238M5	E239M5
6	1.00	80	10	6.0	4.9	8	3	5.0	30	E238M6	E239M6
8	1.25	90	13	8.0	6.2	9	3	6.8	33	E238M8	E239M8
10	1.50	100	15	10.0	8.0	11	3	8.5	39	E238M10	E239M10
12	1.75	110	18	9.0	7.0	10	4	10.3	-	E238M12	E239M12
14	2.00	110	20	11.0	9.0	12	4	12.0	-	E238M14	E239M14
16	2.00	110	20	12.0	9.0	12	4	14.0	-	E238M16	E239M16
18	2.50	125	25	14.0	11.0	14	4	15.5	-	E238M18	
20	2.50	140	25	16.0	12.0	15	4	17.5	-	E238M20	E239M20
22	2.50	140	25	18.0	14.5	17	4	19.8	-	E238M22	
24	3.00	160	30	18.0	14.5	17	4	21.0	-	E238M24	
27	3.00	160	30	20.0	16.0	19	4	24.0	-	E238M27	
30	3.50	180	36	22.0	18.0	21	4	26.5	-	E238M30	



- E473**
- M机用螺旋槽35°丝锥，绿圈鲨鱼丝锥
 - M Macho Máquina Canal Helicoidal 35°, Shark - Anel Verde
- E474**
- M Macho de máquina helicoidal 35° Shark (Anillo Verde)
 - M Machine Tap Spiral Flute 35°, Green Shark

E473	▪	6.2	6.3	7.1	7.2	7.3	8.1
	•	1.1	1.2	1.3	6.1	7.4	
E474	▪	4.1	5.1	6.2	7.2	7.3	7.4
	•	1.2	1.3	6.3	7.1	8.1	

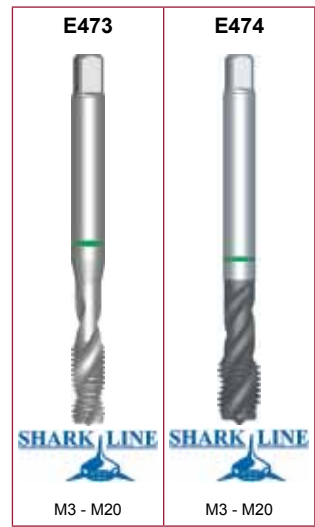
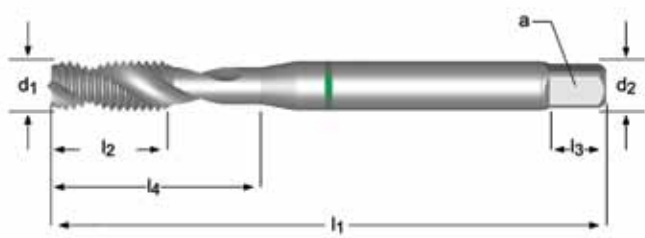

M	P mm	l ₁ mm	l ₂ mm	d ₂ ∅ mm	a mm	l ₃ mm	z	λ	l ₄ mm	E473	E474
3	0.50	56	9	3.5	2.7	6	2	2.5	18	E473M3	E474M3
4	0.70	63	12	4.5	3.4	6	2	3.3	21	E473M4	E474M4
5	0.80	70	13	6.0	4.9	8	2	4.2	25	E473M5	E474M5
6	1.00	80	15	6.0	4.9	8	2	5.0	30	E473M6	E474M6
8	1.25	90	18	8.0	6.2	9	2	6.8	35	E473M8	E474M8
10	1.50	100	20	10.0	8.0	11	2	8.5	39	E473M10	E474M10
12	1.75	110	23	9.0	7.0	10	3	10.3	-	E473M12	E474M12
16	2.00	110	25	12.0	9.0	12	3	14.0	-	E473M16	E474M16
20	2.50	140	30	16.0	12.0	15	3	17.5	-	E473M20	E474M20



E002

- M 机用丝锥 螺旋槽 45°

E002TIN

- M Macho Máquina Canal Helicoidal 45°

E003

- M Machos de máquina Estrías helicoidales a 45°

- M Machine Tap Spiral Flute 45°

E002	■	1.1	1.2	1.3	1.4	1.5	7.1	7.2	7.3	7.4
	•	4.1	4.2	5.1	5.2					
E002TIN	■	1.1	1.2	1.3	1.4	1.5	2.1	2.2	7.3	7.4
	•	2.3	3.1	3.2	3.3	3.4	4.1	4.2	5.1	5.2
E003	■	1.1	1.2	1.3	1.4	1.5				
	•	2.1	2.2	2.3						

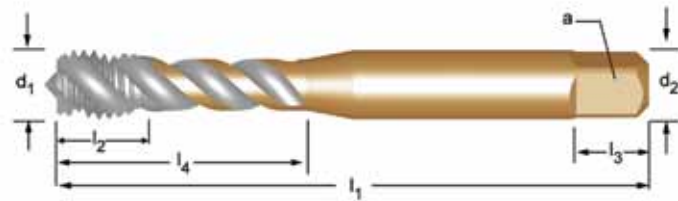

M2 - M24

M3 - M20

M2 - M24

M	P mm	l ₁ mm	l ₂ mm	d ₂ ∅ mm	□ a mm	l ₃ mm	z	l ₄ mm	E002	E002TIN	E003	
2	0.40	41	8	2.50	2.00	4	2	1.6	8	E002M2	E003M2	
2.5	0.45	44.5	9.5	2.80	2.24	5	2	2.05	9.5	E002M2.5	E003M2.5	
3	0.50	48	6	3.15	2.50	5	3	2.5	12.5	E002M3	E002TINM3	E003M3
3.5	0.60	50	16	3.55	2.80	5	3	2.9	16	E002M3.5	E003M3.5	
4	0.70	53	7	4.00	3.15	6	3	3.3	19	E002M4	E002TINM4	E003M4
5	0.80	58	8	5.00	4.00	7	3	4.2	22	E002M5	E002TINM5	E003M5
6	1.00	66	10	6.30	5.00	8	3	5.0	27	E002M6	E002TINM6	E003M6
7	1.00	66	13	7.10	5.60	8	3	6	26	E002M7	E003M7	
8	1.25	72	12	8.00	6.30	9	3	6.8	31	E002M8	E002TINM8	E003M8
10	1.50	80	15	10.00	8.00	11	3	8.5	35	E002M10	E002TINM10	E003M10
12	1.75	89	16	9.00	7.10	10	3	10.3	-	E002M12	E002TINM12	E003M12
14	2.00	95	18	11.20	9.00	12	3	12.0	-	E002M14	E003M14	
16	2.00	102	18	12.50	10.00	13	4	14.0	-	E002M16	E002TINM16	E003M16
18	2.50	112	29	14.00	11.20	14	4	15.5	-	E002M18	E003M18	
20	2.50	112	29	14.00	11.20	14	4	17.5	-	E002M20	E002TINM20	E003M20
22	2.50	118	29	16.00	12.50	16	4	19.5	-	E002M22	E003M22	
24	3.00	130	35	18.00	14.00	18	4	21.0	-	E002M24	E003M24	

E650

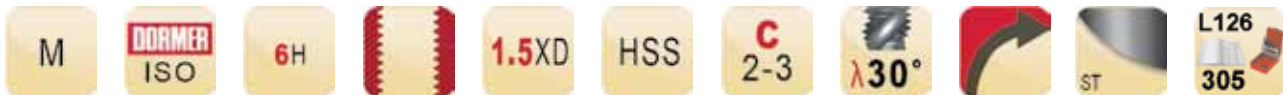

- M 钻攻复合刀具 螺旋槽 30°
- M Broca-Macho Canal Helicoidal 30°
- M Combinación broca-macho Estrías helicoidales a 30°
- M Combi Taps Spiral Flute 30°

E650

E650 • 1.1 1.2 1.3 1.4 3.2 6.2 6.3 7.1 7.2 8.1

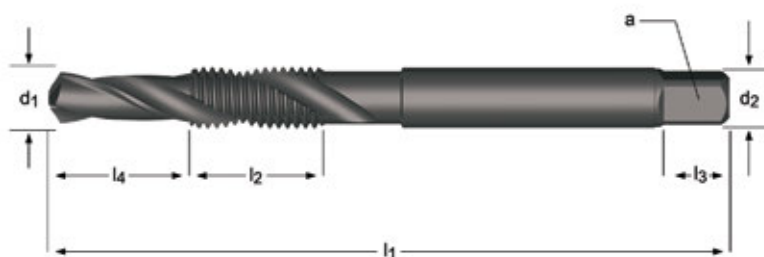

M	P mm	d ₁ Ø mm	l ₁ mm	l ₂ mm	l ₄ mm	d ₂ Ø mm	∠ a mm	l ₃ mm	z	E650
3	0.50	2.5	56	10	6	3.15	2.5	5.0	2	E650M3
4	0.70	3.3	65	12	8	4.0	3.15	6.0	2	E650M4
5	0.80	4.2	69	15	10	5.0	4.00	7.0	2	E650M5
6	1.00	5.0	84	18	12	6.3	5.00	8.0	2	E650M6
8	1.25	6.8	96	21	16	8.0	6.30	9.0	2	E650M8
10	1.50	8.5	108	22	20	10.0	8.00	11.0	2	E650M10
12	1.75	10.2	113	29	24	9.0	7.10	10.0	2	E650M12
14	2.00	12.0	123	30	28	11.2	9.00	12.0	2	E650M14
16	2.00	14.0	134	32	32	12.5	10.00	13.0	2	E650M16

E605



- M 机用丝锥, 超长, 螺旋槽 40°
- M Macho Máquina Extra Longo Canal Helicoidal 40°
- M Machos de máquina Extra largo Estrías helicoidales a 40°
- M Machine Tap, Extra Long Spiral Flute 40°

E605

E605 • 1.2 1.3 1.4 1.5 2.1 2.2 2.3 5.2 7.1 7.2 7.3 7.4

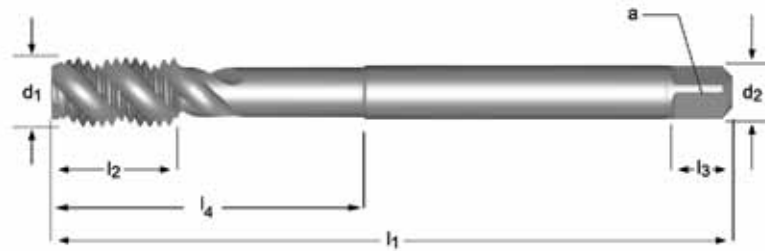

E605



M3 - M20

M	P mm	l_1 mm	l_2 mm	d_2 Ø mm	□ a mm	l_3 mm	z		l_4 mm	E605
3	0.50	66	9	3.15	2.50	5	2	2.5	21	E605M3
4	0.70	73	9	4.00	3.15	6	2	3.3	22	E605M4
5	0.80	79	12	5.00	4.00	7	3	4.2	26	E605M5
6	1.00	89	12	6.30	5.00	8	3	5	29	E605M6
8	1.25	97	12	6.30	5.00	8	3	6.8	-	E605M8
10	1.50	108	14	8.00	6.30	9	3	8.5	-	E605M10
12	1.75	119	23	9.00	7.10	10	3	10.3	-	E605M12
14	2.00	127	25	11.20	9.00	12	3	12	-	E605M14
16	2.00	137	25	12.50	10.00	13	3	14	-	E605M16
20	2.50	149	30	14.00	11.20	14	3	17.5	-	E605M20

E291	M	DIN 2174	6HX		3XD	HSS-E	C 2-3.5			
E292	M	DIN 2174	6HX		3XD	HSS-E	C 2-3.5			TIN
E293	M	DIN 2174	6HX		3XD	HSS-E	E 1.5-2			TIN
E294	M	DIN 2174	6HX		3.5XD	HSS-E	C 2-3.5			TIN

- E291** • M 机用挤压丝锥
- E292** • M Macho Máquina de Laminação
- E293** • M Machos de laminación
- E294** • M Machine Forming Tap
- M机用挤压丝锥，油槽
 - M Macho Máquina de Laminação com ranhuras para Lubrificação
 - M Machos de laminación, con ranuras de lubricación
 - M Machine Forming Tap, Oil Grooves

E291	▪	1.1	1.2	1.3	1.4	7.1	7.2						
	•	7.3											
E292; E293; E294	▪	1.1	1.2	1.3	1.4	2.1	2.2	4.1	5.1	7.1	7.2	7.3	
	•	1.5	2.3	5.2	6.1	6.3	7.4						

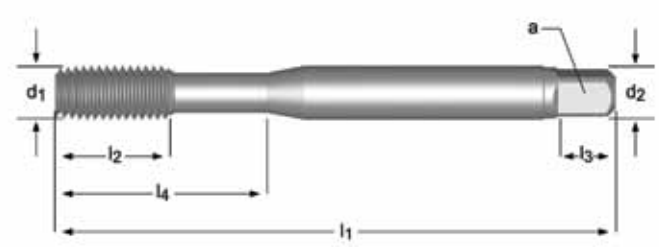

M	P mm	l ₁ mm	l ₂ mm	d ₂ mm	□ a mm	l ₃ mm	z		l ₄ mm	E291	E292	E293	E294
1.6	0.35	40	8	2.5	2.1	5	3	1.4	-	E291M1.6	E292M1.6		
2	0.40	45	6	2.8	2.1	5	3	1.8	-	E291M2	E292M2		
2.5	0.45	50	8	2.8	2.1	5	3	2.3	-	E291M2.5	E292M2.5		
3	0.50	56	9	3.5	2.7	6	4	2.8	18	E291M3	E292M3	E293M3	E294M3
3.5	0.60	56	11	4.0	3.0	6	4	3.2	20	E291M3.5	E292M3.5		
4	0.70	63	12	4.5	3.4	6	5	3.7	21	E291M4	E292M4	E293M4	E294M4
5	0.80	70	13	6.0	4.9	8	5	4.6	25	E291M5	E292M5	E293M5	E294M5
6	1.00	80	15	6.0	4.9	8	5	5.5	30	E291M6	E292M6	E293M6	E294M6
8	1.25	90	18	8.0	6.2	9	5	7.4	35	E291M8	E292M8	E293M8	E294M8
10	1.50	100	20	10.0	8.0	11	5	9.3	39	E291M10	E292M10	E293M10	E294M10
12	1.75	110	23	9.0	7.0	10	5	11.2	-	E291M12	E292M12		E294M12
14	2.00	110	25	11.0	9.0	12	6	13.0	-				E294M14
16	2.00	110	25	12.0	9.0	12	8	15.0	-	E291M16	E292M16		E294M16



- E295**
- M 机用挤压丝锥
 - M Macho Máquina de Laminação
- E296**
- M Machos de laminación
 - M Machine Forming Tap

E295; E296	▪	1.1	1.2	1.3	1.4	2.1	2.2	4.1	5.1	7.1	7.2	7.3
	•	1.5	2.3	5.2	6.1	6.3	7.4					

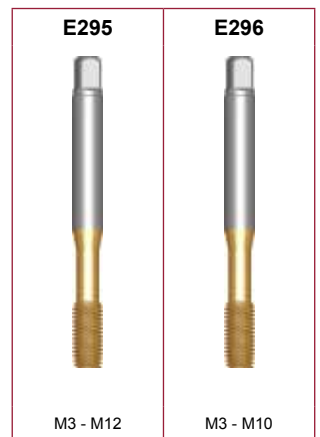
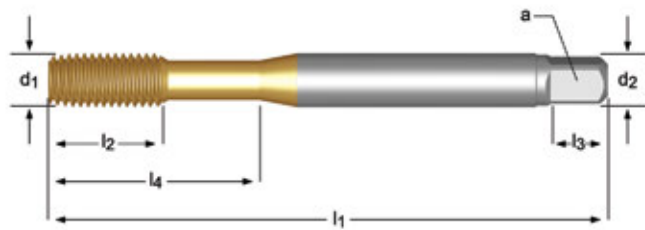

M	P mm	l ₁ mm	l ₂ mm	d ₂ Ø mm	□ a mm	l ₃ mm	z		l ₄ mm	E295	E296
3	0.50	56	9	3.5	2.7	6	4	2.8	18	E295M3	E296M3
3.5	0.60	56	11	4.0	3.0	6	4	3.2	20	E295M3.5	
4	0.70	63	12	4.5	3.4	6	5	3.7	21	E295M4	E296M4
5	0.80	70	13	6.0	4.9	8	5	4.6	25	E295M5	E296M5
6	1.00	80	15	6.0	4.9	8	5	5.5	30	E295M6	E296M6
8	1.25	90	18	8.0	6.2	9	5	7.4	35	E295M8	E296M8
10	1.50	100	20	10.0	8.0	11	5	9.3	39	E295M10	E296M10
12	1.75	110	23	9.0	7.0	10	5	11.2	-	E295M12	

E105

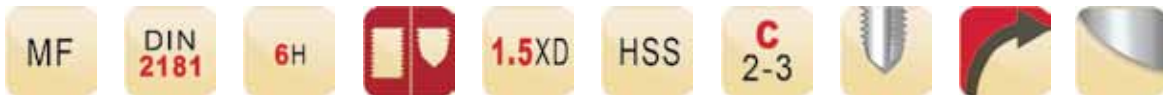

- MF 手用丝锥 直槽
- MF Macho Manual Canal Reto
- MF Machos de mano Estrías rectas
- MF Hand Tap Straight Flute

E105

E105	1.1	1.2	1.3	1.4	1.5	3.1	3.2	3.3	3.4	6.1	6.2	6.3	6.4	7.2	7.3	7.4	8.2	8.3
------	-----	-----	-----	-----	-----	-----	-----	-----	-----	-----	-----	-----	-----	-----	-----	-----	-----	-----

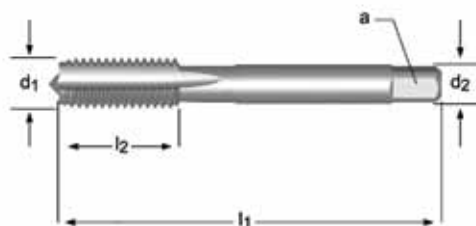

MF	P mm	l_1 mm	l_2 mm	d_2 mm	\square a mm	z		E105
2.5	0.35	40	9	2.8	2.1	3	2.15	E105M2.5X.35NO3
2.5	0.35	40	9	2.8	2.1	3	2.15	E105M2.5X.35NO9
3	0.35	40	9	3.5	2.7	3	2.65	E105M3X.35NO3
3	0.35	40	9	3.5	2.7	3	2.65	E105M3X.35NO9
3.5	0.35	45	10	4.0	3.0	3	3.2	E105M3.5X.35NO3
3.5	0.35	45	10	4.0	3.0	3	3.2	E105M3.5X.35NO9
4	0.50	45	12	4.5	3.4	3	3.5	E105M4X.5NO3
4	0.50	45	12	4.5	3.4	3	3.5	E105M4X.5NO9
5	0.50	50	14	6.0	4.9	3	4.5	E105M5X.5NO3
5	0.50	50	14	6.0	4.9	3	4.5	E105M5X.5NO9
5.5	0.50	56	16	6.0	4.9	3	5	E105M5.5X.5NO9
6	0.75	56	16	6.0	4.9	3	5.3	E105M6X.75NO3
6	0.75	56	16	6.0	4.9	3	5.3	E105M6X.75NO9
7	0.75	56	16	6.0	4.9	3	6.3	E105M7X.75NO3
7	0.75	56	16	6.0	4.9	3	6.3	E105M7X.75NO9
8	0.75	56	16	6.0	4.9	3	7.3	E105M8X.75NO3
8	0.75	56	16	6.0	4.9	3	7.3	E105M8X.75NO9
8	1.00	63	19	6.0	4.9	3	7	E105M8X1.0NO3
8	1.00	63	19	6.0	4.9	3	7	E105M8X1.0NO9
9	0.75	63	19	7.0	5.5	3	8.3	E105M9X.75NO3
9	0.75	63	19	7.0	5.5	3	8.3	E105M9X.75NO9
9	1.00	63	19	7.0	5.5	3	8	E105M9X1.0NO3
9	1.00	63	19	7.0	5.5	3	8	E105M9X1.0NO9
10	0.75	63	16	7.0	5.5	3	9.3	E105M10X.75NO3
10	0.75	63	16	7.0	5.5	3	9.3	E105M10X.75NO9
10	1.00	63	16	7.0	5.5	3	9	E105M10X1.0NO3
10	1.00	63	16	7.0	5.5	3	9	E105M10X1.0NO9
10	1.25	70	22	7.0	5.5	3	8.8	E105M10X1.25NO3
10	1.25	70	22	7.0	5.5	3	8.8	E105M10X1.25NO9
11	0.75	63	15	8.0	6.2	3	10.3	E105M11X.75NO3
11	0.75	63	15	8.0	6.2	3	10.3	E105M11X.75NO9
11	1.00	63	15	8.0	6.2	3	10	E105M11X1.0NO3
11	1.00	63	15	8.0	6.2	3	10	E105M11X1.0NO9
12	1.00	70	16	9.0	7.0	3	11	E105M12X1.0NO3
12	1.00	70	16	9.0	7.0	3	11	E105M12X1.0NO9
12	1.25	70	16	9.0	7.0	3	10.8	E105M12X1.25NO3
12	1.25	70	16	9.0	7.0	3	10.8	E105M12X1.25NO9
12	1.50	70	16	9.0	7.0	3	10.5	E105M12X1.5NO3

NO1
NO9
198

MF	P mm	l ₁ mm	l ₂ mm	d ₂ Ø mm	□ a mm	z		E105
12	1.50	70	16	9.0	7.0	3	10.5	E105M12X1.5NO9
14	1.00	70	16	11.0	9.0	4	13	E105M14X1.0NO3
14	1.00	70	16	11.0	9.0	4	13	E105M14X1.0NO9
14	1.25	70	16	11.0	9.0	4	12.8	E105M14X1.25NO3
14	1.25	70	16	11.0	9.0	4	12.8	E105M14X1.25NO9
14	1.50	70	16	11.0	9.0	4	12.5	E105M14X1.5NO3
14	1.50	70	16	11.0	9.0	4	12.5	E105M14X1.5NO9
15	1.00	70	16	12.0	9.0	4	14	E105M15X1.0NO3
15	1.00	70	16	12.0	9.0	4	14	E105M15X1.0NO9
15	1.50	70	16	12.0	9.0	4	13.5	E105M15X1.5NO3
15	1.50	70	16	12.0	9.0	4	13.5	E105M15X1.5NO9
16	1.00	70	16	12.0	9.0	4	15	E105M16X1.0NO3
16	1.00	70	16	12.0	9.0	4	15	E105M16X1.0NO9
16	1.50	70	16	12.0	9.0	4	14.5	E105M16X1.5NO3
16	1.50	70	16	12.0	9.0	4	14.5	E105M16X1.5NO9
18	1.00	80	18	14.0	11.0	4	17	E105M18X1.0NO3
18	1.00	80	18	14.0	11.0	4	17	E105M18X1.0NO9
18	1.50	80	18	14.0	11.0	4	16.5	E105M18X1.5NO3
18	1.50	80	18	14.0	11.0	4	16.5	E105M18X1.5NO9
20	1.00	80	18	16.0	12.0	4	19	E105M20X1.0NO3
20	1.00	80	18	16.0	12.0	4	19	E105M20X1.0NO9
20	1.50	80	18	16.0	12.0	4	18.5	E105M20X1.5NO3
20	1.50	80	18	16.0	12.0	4	18.5	E105M20X1.5NO9
22	1.00	80	22	18.0	14.5	4	21	E105M22X1.0NO3
22	1.00	80	22	18.0	14.5	4	21	E105M22X1.0NO9
22	1.50	80	22	18.0	14.5	4	20.5	E105M22X1.5NO3
22	1.50	80	22	18.0	14.5	4	20.5	E105M22X1.5NO9
24	1.00	90	22	18.0	14.5	4	23	E105M24X1.0NO3
24	1.00	90	22	18.0	14.5	4	23	E105M24X1.0NO9
24	1.50	90	22	18.0	14.5	4	22.5	E105M24X1.5NO3
24	1.50	90	22	18.0	14.5	4	22.5	E105M24X1.5NO9
24	2.00	90	22	18.0	14.5	4	22	E105M24X2.0NO3
24	2.00	90	22	18.0	14.5	4	22	E105M24X2.0NO9
25	1.50	90	22	18.0	14.5	4	23.5	E105M25X1.5NO3
25	1.50	90	22	18.0	14.5	4	23.5	E105M25X1.5NO9
25	2.00	90	22	18.0	14.5	4	23	E105M25X2.0NO3
25	2.00	90	22	18.0	14.5	4	23	E105M25X2.0NO9
27	1.50	90	22	20.0	16.0	4	25.5	E105M27X1.5NO3
27	1.50	90	22	20.0	16.0	4	25.5	E105M27X1.5NO9
27	2.00	90	22	20.0	16.0	4	25	E105M27X2.0NO3
27	2.00	90	22	20.0	16.0	4	25	E105M27X2.0NO9
28	1.50	90	22	20.0	16.0	4	26.5	E105M28X1.5NO3
28	1.50	90	22	20.0	16.0	4	26.5	E105M28X1.5NO9
28	2.00	90	22	20.0	16.0	4	26	E105M28X2.0NO3
28	2.00	90	22	20.0	16.0	4	26	E105M28X2.0NO9
30	1.50	90	22	22.0	18.0	4	28.5	E105M30X1.5NO3
30	1.50	90	22	22.0	18.0	4	28.5	E105M30X1.5NO9
30	2.00	90	22	22.0	18.0	4	28	E105M30X2.0NO3
30	2.00	90	22	22.0	18.0	4	28	E105M30X2.0NO9
32	1.50	90	22	22.0	18.0	4	30.5	E105M32X1.5NO3
32	1.50	90	22	22.0	18.0	4	30.5	E105M32X1.5NO9
32	2.00	90	22	22.0	18.0	4	30	E105M32X2.0NO3
32	2.00	90	22	22.0	18.0	4	30	E105M32X2.0NO9
36	1.50	100	25	28.0	22.0	4	34.5	E105M36X1.5NO3
36	1.50	100	25	28.0	22.0	4	34.5	E105M36X1.5NO9
36	2.00	125	40	28.0	22.0	4	34	E105M36X2.0NO3
36	2.00	125	40	28.0	22.0	4	34	E105M36X2.0NO9
36	3.00	125	40	28.0	22.0	4	33	E105M36X3.0NO3
36	3.00	125	40	28.0	22.0	4	33	E105M36X3.0NO9
40	1.50	110	25	32.0	24.0	4	38.5	E105M40X1.5NO3
40	1.50	110	25	32.0	24.0	4	38.5	E105M40X1.5NO9
40	2.00	125	40	32.0	24.0	4	38	E105M40X2.0NO3
40	2.00	125	40	32.0	24.0	4	38	E105M40X2.0NO9
40	3.00	125	40	32.0	24.0	4	37	E105M40X3.0NO3
40	3.00	125	40	32.0	24.0	4	37	E105M40X3.0NO9
42	1.50	110	25	32.0	24.0	4	40.5	E105M42X1.5NO3
42	1.50	110	25	32.0	24.0	4	40.5	E105M42X1.5NO9
42	2.00	125	40	32.0	24.0	4	40	E105M42X2.0NO3
42	2.00	125	40	32.0	24.0	4	40	E105M42X2.0NO9
42	3.00	125	40	32.0	24.0	4	39	E105M42X3.0NO3



MF	P mm	l ₁ mm	l ₂ mm	d ₂ ∅ mm	□ a mm	z		E105
42	3.00	125	40	32.0	24.0	4	39	E105M42X3.0NO9
45	1.50	110	25	36.0	29.0	6	43.5	E105M45X1.5NO3
45	1.50	110	25	36.0	29.0	6	43.5	E105M45X1.5NO9
45	2.00	125	40	36.0	29.0	6	43	E105M45X2.0NO3
45	2.00	125	40	36.0	29.0	6	43	E105M45X2.0NO9
45	3.00	125	40	36.0	29.0	6	42	E105M45X3.0NO3
45	3.00	125	40	36.0	29.0	6	42	E105M45X3.0NO9
48	1.50	140	40	36.0	29.0	6	46.5	E105M48X1.5NO3
48	1.50	140	40	36.0	29.0	6	46.5	E105M48X1.5NO9
48	2.00	140	40	36.0	29.0	6	46	E105M48X2.0NO3
48	2.00	140	40	36.0	29.0	6	46	E105M48X2.0NO9
48	3.00	140	40	36.0	29.0	6	45	E105M48X3.0NO3
48	3.00	140	40	36.0	29.0	6	45	E105M48X3.0NO9
50	1.50	140	40	36.0	29.0	6	48.5	E105M50X1.5NO3
50	1.50	140	40	36.0	29.0	6	48.5	E105M50X1.5NO9
50	2.00	140	40	36.0	29.0	6	48	E105M50X2.0NO3
50	2.00	140	40	36.0	29.0	6	48	E105M50X2.0NO9
50	3.00	140	40	36.0	29.0	6	47	E105M50X3.0NO3
50	3.00	140	40	36.0	29.0	6	47	E105M50X3.0NO9





- E268** • MF 机用丝锥 直槽
- E242** • MF Macho Máquina Canal Reto
- E290** • MF Machine Tap Straight Flute

E268; E242; E290 • 1.1 1.2 1.3 1.4 1.5 3.1 3.2 3.3 6.2 6.3 7.2 7.3 8.2

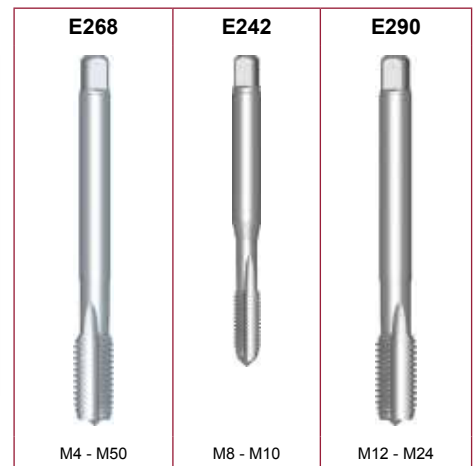
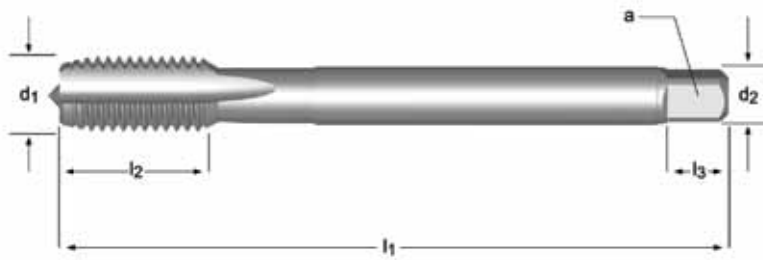

MF	P mm	l ₁ mm	l ₂ mm	d ₂ Ø mm	□ a mm	l ₃ mm	z	↔ mm	l ₄ mm	E268	E242	E290
4	0.50	63	10	2.8	2.1	5	3	3.5	-	E268M4X.5		
5	0.50	70	13	3.5	2.7	6	3	4.5	-	E268M5X.5		
6	0.75	80	15	4.5	3.4	6	3	5.3	-	E268M6X.75		
7	0.75	80	15	5.5	4.3	7	3	6.3	-	E268M7X.75		
8	0.75	80	15	6.0	4.9	8	3	7.3	-	E268M8X.75		
8	1.00	90	18	6.0	4.9	8	3	7.0	-	E268M8X1.0		
8	1.00	90	18	8.0	6.2	9	3	7.0	35		E242M8X1.0	
9	1.00	90	18	6.0	4.9	8	3	8.0	-	E268M9X1.0		
10	0.75	90	20	7.0	5.5	8	3	9.3	-	E268M10X.75		
10	1.00	100	20	10.0	8.0	11	3	9.0	39		E242M10X1.0	
10	1.00	90	20	7.0	5.5	8	3	9.0	-	E268M10X1.0		
10	1.25	100	20	7.0	5.5	8	3	8.8	-	E268M10X1.25		
11	1.00	90	20	8.0	6.2	9	3	10.0	-	E268M11X1.0		
12	1.00	100	21	9.0	7.0	10	4	11.0	-	E268M12X1.0		E290M12X1.0
12	1.25	100	21	9.0	7.0	10	4	10.8	-	E268M12X1.25		
12	1.50	100	21	9.0	7.0	10	4	10.5	-	E268M12X1.5		E290M12X1.5
14	1.00	100	21	11.0	9.0	12	4	13.0	-	E268M14X1.0		E290M14X1.0
14	1.25	100	21	11.0	9.0	12	4	12.8	-	E268M14X1.25		
14	1.50	100	21	11.0	9.0	12	4	12.5	-	E268M14X1.5		E290M14X1.5
15	1.50	100	21	12.0	9.0	12	4	13.5	-	E268M15X1.5		
16	1.00	100	21	12.0	9.0	12	4	15.0	-	E268M16X1.0		E290M16X1.0
16	1.50	100	21	12.0	9.0	12	4	14.5	-	E268M16X1.5		E290M16X1.5
18	1.00	110	24	14.0	11.0	14	4	17.0	-	E268M18X1.0		
18	1.50	110	24	14.0	11.0	14	4	16.5	-	E268M18X1.5		E290M18X1.5
20	1.00	125	24	16.0	12.0	15	4	19.0	-	E268M20X1.0		
20	1.50	125	24	16.0	12.0	15	4	18.5	-	E268M20X1.5		E290M20X1.5
22	1.00	125	25	18.0	14.5	17	4	21.0	-	E268M22X1.0		
22	1.50	125	25	18.0	14.5	17	4	20.5	-	E268M22X1.5		E290M22X1.5

MF	P mm	l ₁ mm	l ₂ mm	d ₂ ∅ mm	a mm	l ₃ mm	z	 mm	l ₄ mm	E268	E242	E290
24	1.00	140	28	18.0	14.5	17	4	23.0	-	E268M24X1.0		
24	1.50	140	28	18.0	14.5	17	4	22.5	-	E268M24X1.5		E290M24X1.5
24	2.00	140	28	18.0	14.5	17	4	22.0	-	E268M24X2.0		
25	1.50	140	28	18.0	14.5	17	4	23.5	-	E268M25X1.5		
25	2.00	140	28	18.0	14.5	17	4	23.0	-	E268M25X2.0		
26	1.50	140	28	18.0	14.5	17	4	24.5	-	E268M26X1.5		
26	2.00	140	28	18.0	14.5	17	4	24.0	-	E268M26X2.0		
27	1.50	140	28	20.0	16.0	19	4	25.5	-	E268M27X1.5		
27	2.00	140	28	20.0	16.0	19	4	25.0	-	E268M27X2.0		
28	1.50	140	28	20.0	16.0	19	4	26.5	-	E268M28X1.5		
28	2.00	140	28	20.0	16.0	19	4	26.0	-	E268M28X2.0		
30	1.50	150	28	22.0	18.0	21	4	28.5	-	E268M30X1.5		
30	2.00	150	28	22.0	18.0	21	4	28.0	-	E268M30X2.0		
32	1.50	150	28	22.0	18.0	21	4	30.5	-	E268M32X1.5		
32	2.00	150	28	22.0	18.0	21	4	30.0	-	E268M32X2.0		
33	1.50	160	30	25.0	20.0	23	4	31.5	-	E268M33X1.5		
34	1.50	170	30	28.0	22.0	25	4	32.5	-	E268M34X1.5		
35	1.50	170	30	28.0	22.0	25	4	33.5	-	E268M35X1.5		
36	1.50	170	30	28.0	22.0	25	4	34.5	-	E268M36X1.5		
36	2.00	170	30	28.0	22.0	25	4	34.0	-	E268M36X2.0		
36	3.00	200	55	28.0	22.0	25	4	33.0	-	E268M36X3.0		
40	1.50	170	30	32.0	24.0	27	4	38.5	-	E268M40X1.5		
40	2.00	170	30	32.0	24.0	27	4	38.0	-	E268M40X2.0		
40	3.00	200	60	32.0	24.0	27	4	37.0	-	E268M40X3.0		
42	1.50	170	30	32.0	24.0	27	4	40.5	-	E268M42X1.5		
42	2.00	170	30	32.0	24.0	27	4	40.0	-	E268M42X2.0		
42	3.00	200	60	32.0	24.0	27	4	39.0	-	E268M42X3.0		
45	1.50	180	32	36.0	29.0	32	6	43.5	-	E268M45X1.5		
45	2.00	180	32	36.0	29.0	32	6	43.0	-	E268M45X2.0		
45	3.00	200	42	36.0	29.0	32	6	42.0	-	E268M45X3.0		
48	1.50	190	32	36.0	29.0	32	6	46.5	-	E268M48X1.5		
48	2.00	190	32	36.0	29.0	32	6	46.0	-	E268M48X2.0		
48	3.00	225	50	36.0	29.0	32	6	45.0	-	E268M48X3.0		
50	1.50	190	32	36.0	29.0	32	6	48.5	-	E268M50X1.5		
50	2.00	190	30	36.0	29.0	32	6	48.0	-	E268M50X2.0		
50	3.00	225	50	36.0	29.0	32	6	47.0	-	E268M50X3.0		

E513

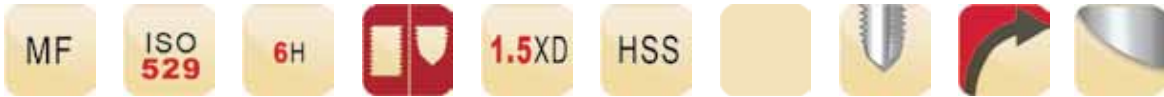

- MF 机用丝锥 直槽
- MF Macho Máquina Canal Reto
- MF Machos de máquina Estrías rectas
- MF Machine Tap Straight Flute

E513

E513	1.1	1.2	1.3	1.4	1.5	3.1	3.2	3.3	3.4	6.1	6.2	6.3	6.4	7.2	7.3	7.4	8.2	8.3
------	-----	-----	-----	-----	-----	-----	-----	-----	-----	-----	-----	-----	-----	-----	-----	-----	-----	-----

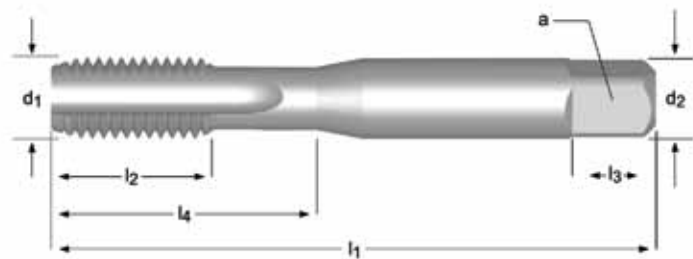

MF	P mm	l_1 mm	l_2 mm	d_2 Ø mm	\square a mm	l_3 mm	z		l_4 mm	E513
3	0.35	48	12.5	3.15	2.50	5	3	2.65	12.5	E513M3X.35NO1
3	0.35	48	12.5	3.15	2.50	5	3	2.65	12.5	E513M3X.35NO2
3	0.35	48	12.5	3.15	2.50	5	3	2.65	12.5	E513M3X.35NO3
3.5	0.35	48	12.5	3.15	2.50	5	3	3.2	12.5	E513M3.5X.35NO3
4	0.50	53	14	4.00	3.15	6	3	3.5	14	E513M4X.5NO1
4	0.50	53	14	4.00	3.15	6	3	3.5	14	E513M4X.5NO2
4	0.50	53	14	4.00	3.15	6	3	3.5	14	E513M4X.5NO3
4	0.50	53	14	4.00	3.15	6	3	3.5	14	E513M4X.5NO7
5	0.50	58	11	5.00	4.00	7	3	4.5	22	E513M5X.5NO1
5	0.50	58	11	5.00	4.00	7	3	4.5	22	E513M5X.5NO2
5	0.50	58	11	5.00	4.00	7	3	4.5	22	E513M5X.5NO3
5	0.50	58	11	5.00	4.00	7	3	4.5	22	E513M5X.5NO7
5	0.75	58	11	5.00	4.00	7	3	4.3	22	E513M5X.75NO1
5	0.75	58	11	5.00	4.00	7	3	4.3	22	E513M5X.75NO2
5	0.75	58	11	5.00	4.00	7	3	4.3	22	E513M5X.75NO3
6	0.50	66	13	6.30	5.00	8	3	5.5	26	E513M6X.5NO1
6	0.50	66	13	6.30	5.00	8	3	5.5	26	E513M6X.5NO2
6	0.50	66	13	6.30	5.00	8	3	5.5	26	E513M6X.5NO3
6	0.75	66	13	6.30	5.00	8	3	5.3	26	E513M6X.75NO1
6	0.75	66	13	6.30	5.00	8	3	5.3	26	E513M6X.75NO2
6	0.75	66	13	6.30	5.00	8	3	5.3	26	E513M6X.75NO3
6	0.75	66	13	6.30	5.00	8	3	5.3	26	E513M6X.75NO7
7	0.75	66	13	7.10	5.60	8	3	6.3	26	E513M7X.75NO1
7	0.75	66	13	7.10	5.60	8	3	6.3	26	E513M7X.75NO2
7	0.75	66	13	7.10	5.60	8	3	6.3	26	E513M7X.75NO3
8	0.50	72	16	8.00	6.30	9	3	7.5	29	E513M8X.5NO1
8	0.50	72	16	8.00	6.30	9	3	7.5	29	E513M8X.5NO2
8	0.50	72	16	8.00	6.30	9	3	7.5	29	E513M8X.5NO3
8	0.75	72	16	8.00	6.30	9	3	7.3	29	E513M8X.75NO1
8	0.75	72	16	8.00	6.30	9	3	7.3	29	E513M8X.75NO2
8	0.75	72	16	8.00	6.30	9	3	7.3	29	E513M8X.75NO3
8	0.75	72	16	8.00	6.30	9	3	7.3	29	E513M8X.75NO7
8	1.00	72	16	8.00	6.30	9	3	7	29	E513M8X1.0NO1
8	1.00	72	16	8.00	6.30	9	3	7	29	E513M8X1.0NO2
8	1.00	72	16	8.00	6.30	9	3	7	29	E513M8X1.0NO3
8	1.00	72	16	8.00	6.30	9	3	7	29	E513M8X1.0NO7
9	0.75	72	16	9.00	7.10	10	3	8.3	29	E513M9X.75NO3
9	1.00	72	16	9.00	7.10	10	3	8	29	E513M9X1.0NO1
9	1.00	72	16	9.00	7.10	10	3	8	29	E513M9X1.0NO2
9	1.00	72	16	9.00	7.10	10	3	8	29	E513M9X1.0NO3

NO1
NO9
198

MF	P mm	l ₁ mm	l ₂ mm	d ₂ Ø mm	a mm	l ₃ mm	z		l ₄ mm	E513
10	0.50	80	18	10.00	8.00	11	3	9.5	34	E513M10X.5NO3
10	0.75	80	18	10.00	8.00	11	3	9.3	34	E513M10X.75NO1
10	0.75	80	18	10.00	8.00	11	3	9.3	34	E513M10X.75NO2
10	0.75	80	18	10.00	8.00	11	3	9.3	34	E513M10X.75NO3
10	1.00	80	18	10.00	8.00	11	3	9	34	E513M10X1.0NO1
10	1.00	80	18	10.00	8.00	11	3	9	34	E513M10X1.0NO2
10	1.00	80	18	10.00	8.00	11	3	9	34	E513M10X1.0NO3
10	1.00	80	18	10.00	8.00	11	3	9	34	E513M10X1.0NO6
10	1.00	80	18	10.00	8.00	11	3	9	34	E513M10X1.0NO7
10	1.25	80	18	10.00	8.00	11	3	8.8	34	E513M10X1.25NO1
10	1.25	80	18	10.00	8.00	11	3	8.8	34	E513M10X1.25NO2
10	1.25	80	18	10.00	8.00	11	3	8.8	34	E513M10X1.25NO3
10	1.25	80	18	10.00	8.00	11	3	8.8	34	E513M10X1.25NO6
10	1.25	80	18	10.00	8.00	11	3	8.8	34	E513M10X1.25NO7
11	0.75	85	19	8.00	6.30	9	3	10.3	-	E513M11X.75NO1
11	0.75	85	19	8.00	6.30	9	3	10.3	-	E513M11X.75NO2
11	0.75	85	19	8.00	6.30	9	3	10.3	-	E513M11X.75NO3
11	1.00	85	19	8.00	6.30	9	3	10	-	E513M11X1.0NO1
11	1.00	85	19	8.00	6.30	9	3	10	-	E513M11X1.0NO2
11	1.00	85	19	8.00	6.30	9	3	10	-	E513M11X1.0NO3
11	1.25	85	19	8.00	6.30	9	3	9.8	-	E513M11X1.25NO3
12	0.75	89	22	9.00	7.10	10	3	11.3	-	E513M12X.75NO3
12	1.00	89	22	9.00	7.10	10	3	11	-	E513M12X1.0NO1
12	1.00	89	22	9.00	7.10	10	3	11	-	E513M12X1.0NO2
12	1.00	89	22	9.00	7.10	10	3	11	-	E513M12X1.0NO3
12	1.00	89	22	9.00	7.10	10	3	11	-	E513M12X1.0NO7
12	1.25	89	22	9.00	7.10	10	3	10.8	-	E513M12X1.25NO1
12	1.25	89	22	9.00	7.10	10	3	10.8	-	E513M12X1.25NO2
12	1.25	89	22	9.00	7.10	10	3	10.8	-	E513M12X1.25NO3
12	1.25	89	22	9.00	7.10	10	3	10.8	-	E513M12X1.25NO6
12	1.25	89	22	9.00	7.10	10	3	10.8	-	E513M12X1.25NO7
12	1.50	89	22	9.00	7.10	10	3	10.5	-	E513M12X1.5NO1
12	1.50	89	22	9.00	7.10	10	3	10.5	-	E513M12X1.5NO2
12	1.50	89	22	9.00	7.10	10	3	10.5	-	E513M12X1.5NO3
12	1.50	89	22	9.00	7.10	10	3	10.5	-	E513M12X1.5NO6
12	1.50	89	22	9.00	7.10	10	3	10.5	-	E513M12X1.5NO7
13	1.50	89	22	9.00	7.10	10	3	11.5	-	E513M13X1.5NO3
14	1.00	95	24	11.20	9.00	12	4	13	-	E513M14X1.0NO1
14	1.00	95	24	11.20	9.00	12	4	13	-	E513M14X1.0NO2
14	1.00	95	24	11.20	9.00	12	4	13	-	E513M14X1.0NO3
14	1.00	95	24	11.20	9.00	12	4	13	-	E513M14X1.0NO7
14	1.25	95	24	11.20	9.00	12	4	12.8	-	E513M14X1.25NO1
14	1.25	95	24	11.20	9.00	12	4	12.8	-	E513M14X1.25NO2
14	1.25	95	24	11.20	9.00	12	4	12.8	-	E513M14X1.25NO3
14	1.25	95	24	11.20	9.00	12	4	12.8	-	E513M14X1.25NO6
14	1.50	95	24	11.20	9.00	12	4	12.5	-	E513M14X1.5NO1
14	1.50	95	24	11.20	9.00	12	4	12.5	-	E513M14X1.5NO2
14	1.50	95	24	11.20	9.00	12	4	12.5	-	E513M14X1.5NO3
14	1.50	95	24	11.20	9.00	12	4	12.5	-	E513M14X1.5NO6
14	1.50	95	24	11.20	9.00	12	4	12.5	-	E513M14X1.5NO7
15	1.50	95	24	11.20	9.00	12	4	13.5	-	E513M15X1.5NO2
15	1.50	95	24	11.20	9.00	12	4	13.5	-	E513M15X1.5NO3
16	1.00	102	24	12.50	10.00	13	4	15	-	E513M16X1.0NO1
16	1.00	102	24	12.50	10.00	13	4	15	-	E513M16X1.0NO2
16	1.00	102	24	12.50	10.00	13	4	15	-	E513M16X1.0NO3
16	1.00	102	24	12.50	10.00	13	4	15	-	E513M16X1.0NO7
16	1.25	102	24	12.50	10.00	13	4	14.8	-	E513M16X1.25NO3
16	1.50	102	24	12.50	10.00	13	4	14.5	-	E513M16X1.5NO1
16	1.50	102	24	12.50	10.00	13	4	14.5	-	E513M16X1.5NO2
16	1.50	102	24	12.50	10.00	13	4	14.5	-	E513M16X1.5NO3
16	1.50	102	24	12.50	10.00	13	4	14.5	-	E513M16X1.5NO6
16	1.50	102	24	12.50	10.00	13	4	14.5	-	E513M16X1.5NO7
18	1.00	112	29	14.00	11.20	14	4	17	-	E513M18X1.0NO1
18	1.00	112	29	14.00	11.20	14	4	17	-	E513M18X1.0NO2
18	1.00	112	29	14.00	11.20	14	4	17	-	E513M18X1.0NO3
18	1.00	112	29	14.00	11.20	14	4	17	-	E513M18X1.0NO7
18	1.50	112	29	14.00	11.20	14	4	16.5	-	E513M18X1.5NO1
18	1.50	112	29	14.00	11.20	14	4	16.5	-	E513M18X1.5NO2

NO1
NO9
198

MF	P mm	l ₁ mm	l ₂ mm	d ₂ ∅ mm	a mm	l ₃ mm	z		l ₄ mm	E513
18	1.50	112	29	14.00	11.20	14	4	16.5	-	E513M18X1.5NO3
18	1.50	112	29	14.00	11.20	14	4	16.5	-	E513M18X1.5NO6
18	1.50	112	29	14.00	11.20	14	4	16.5	-	E513M18X1.5NO7
18	2.00	112	29	14.00	11.20	14	4	16	-	E513M18X2.0NO1
18	2.00	112	29	14.00	11.20	14	4	16	-	E513M18X2.0NO2
18	2.00	112	29	14.00	11.20	14	4	16	-	E513M18X2.0NO3
18	2.00	112	29	14.00	11.20	14	4	16	-	E513M18X2.0NO7
20	1.00	112	29	14.00	11.20	14	4	19	-	E513M20X1.0NO1
20	1.00	112	29	14.00	11.20	14	4	19	-	E513M20X1.0NO2
20	1.00	112	29	14.00	11.20	14	4	19	-	E513M20X1.0NO3
20	1.00	112	29	14.00	11.20	14	4	19	-	E513M20X1.0NO7
20	1.50	112	29	14.00	11.20	14	4	18.5	-	E513M20X1.5NO1
20	1.50	112	29	14.00	11.20	14	4	18.5	-	E513M20X1.5NO2
20	1.50	112	29	14.00	11.20	14	4	18.5	-	E513M20X1.5NO3
20	1.50	112	29	14.00	11.20	14	4	18.5	-	E513M20X1.5NO6
20	1.50	112	29	14.00	11.20	14	4	18.5	-	E513M20X1.5NO7
20	2.00	112	29	14.00	11.20	14	4	18	-	E513M20X2.0NO1
20	2.00	112	29	14.00	11.20	14	4	18	-	E513M20X2.0NO2
20	2.00	112	29	14.00	11.20	14	4	18	-	E513M20X2.0NO3
20	2.00	112	29	14.00	11.20	14	4	18	-	E513M20X2.0NO7
22	1.00	118	29	16.00	12.50	16	4	21	-	E513M22X1.0NO2
22	1.00	118	29	16.00	12.50	16	4	21	-	E513M22X1.0NO3
22	1.00	118	29	16.00	12.50	16	4	21	-	E513M22X1.0NO7
22	1.50	118	29	16.00	12.50	16	4	20.5	-	E513M22X1.5NO1
22	1.50	118	29	16.00	12.50	16	4	20.5	-	E513M22X1.5NO2
22	1.50	118	29	16.00	12.50	16	4	20.5	-	E513M22X1.5NO3
22	1.50	118	29	16.00	12.50	16	4	20.5	-	E513M22X1.5NO7
22	2.00	118	29	16.00	12.50	16	4	20	-	E513M22X2.0NO1
22	2.00	118	29	16.00	12.50	16	4	20	-	E513M22X2.0NO2
22	2.00	118	29	16.00	12.50	16	4	20	-	E513M22X2.0NO3
22	2.00	118	29	16.00	12.50	16	4	20	-	E513M22X2.0NO7
24	1.00	130	35	18.00	14.00	18	4	23	-	E513M24X1.0NO2
24	1.00	130	35	18.00	14.00	18	4	23	-	E513M24X1.0NO3
24	1.50	130	35	18.00	14.00	18	4	22.5	-	E513M24X1.5NO1
24	1.50	130	35	18.00	14.00	18	4	22.5	-	E513M24X1.5NO2
24	1.50	130	35	18.00	14.00	18	4	22.5	-	E513M24X1.5NO3
24	1.50	130	35	18.00	14.00	18	4	22.5	-	E513M24X1.5NO7
24	2.00	130	35	18.00	14.00	18	4	22	-	E513M24X2.0NO1
24	2.00	130	35	18.00	14.00	18	4	22	-	E513M24X2.0NO2
24	2.00	130	35	18.00	14.00	18	4	22	-	E513M24X2.0NO3
24	2.00	130	35	18.00	14.00	18	4	22	-	E513M24X2.0NO7
25	1.50	130	35	18.00	14.00	18	4	23.5	-	E513M25X1.5NO1
25	1.50	130	35	18.00	14.00	18	4	23.5	-	E513M25X1.5NO2
25	1.50	130	35	18.00	14.00	18	4	23.5	-	E513M25X1.5NO3
25	1.50	130	35	18.00	14.00	18	4	23.5	-	E513M25X1.5NO6
25	1.50	130	35	18.00	14.00	18	4	23.5	-	E513M25X1.5NO7
26	1.50	130	35	18.00	14.00	18	4	24.5	-	E513M26X1.5NO2
26	1.50	130	35	18.00	14.00	18	4	24.5	-	E513M26X1.5NO3
27	1.50	135	35	20.00	16.00	20	4	25.5	-	E513M27X1.5NO2
27	1.50	135	35	20.00	16.00	20	4	25.5	-	E513M27X1.5NO3
27	2.00	135	35	20.00	16.00	20	4	25	-	E513M27X2.0NO3
28	1.50	138	35	20.00	16.00	20	4	26.5	-	E513M28X1.5NO2
28	1.50	138	35	20.00	16.00	20	4	26.5	-	E513M28X1.5NO3
30	1.50	138	41	20.00	16.00	20	4	28.5	-	E513M30X1.5NO2
30	1.50	138	41	20.00	16.00	20	4	28.5	-	E513M30X1.5NO3
30	2.00	138	41	20.00	16.00	20	4	28	-	E513M30X2.0NO2
30	2.00	138	41	20.00	16.00	20	4	28	-	E513M30X2.0NO3
32	1.50	151	41	22.40	18.00	22	4	30.5	-	E513M32X1.5NO1
32	1.50	151	41	22.40	18.00	22	4	30.5	-	E513M32X1.5NO2
32	1.50	151	41	22.40	18.00	22	4	30.5	-	E513M32X1.5NO3
33	2.00	151	41	22.40	18.00	22	4	31	-	E513M33X2.0NO2
33	2.00	151	41	22.40	18.00	22	4	31	-	E513M33X2.0NO3
35	1.50	162	47	25.00	20.00	24	4	33.5	-	E513M35X1.5NO2
35	1.50	162	47	25.00	20.00	24	4	33.5	-	E513M35X1.5NO3
36	1.50	162	47	25.00	20.00	24	4	34.5	-	E513M36X1.5NO3
36	2.00	162	47	25.00	20.00	24	4	34	-	E513M36X2.0NO2
36	2.00	162	47	25.00	20.00	24	4	34	-	E513M36X2.0NO3
36	3.00	162	47	25.00	20.00	24	4	33	-	E513M36X3.0NO2



MF	P mm	l ₁ mm	l ₂ mm	d ₂ ∅ mm	a mm	l ₃ mm	z		l ₄ mm	E513
36	3.00	162	47	25.00	20.00	24	4	33	-	E513M36X3.0NO3
39	3.00	170	47	28.00	22.40	26	4	36	-	E513M39X3.0NO2
39	3.00	170	47	28.00	22.40	26	4	36	-	E513M39X3.0NO3
40	1.50	170	53	28.00	22.40	26	6	38.5	-	E513M40X1.5NO2
40	1.50	170	53	28.00	22.40	26	6	38.5	-	E513M40X1.5NO3
42	1.50	170	53	28.00	22.40	26	6	40.5	-	E513M42X1.5NO2
42	1.50	170	53	28.00	22.40	26	6	40.5	-	E513M42X1.5NO3
42	3.00	170	53	28.00	22.40	26	6	39	-	E513M42X3.0NO3
45	1.50	187	54	31.50	25.00	28	6	43.5	-	E513M45X1.5NO2
45	1.50	187	54	31.50	25.00	28	6	43.5	-	E513M45X1.5NO3
48	1.50	187	60	31.50	25.00	28	6	46.5	-	E513M48X1.5NO3
48	2.00	187	60	31.50	25.00	28	6	46	-	E513M48X2.0NO3
48	3.00	187	60	31.50	25.00	28	6	45	-	E513M48X3.0NO3
50	1.50	187	60	31.50	25.00	28	6	48.5	-	E513M50X1.5NO2
50	1.50	187	60	31.50	25.00	28	6	48.5	-	E513M50X1.5NO3





EP10

- MF 机用丝锥 螺尖

EP10TIN

- MF Macho Máquina Ponta Helicoidal

EP11

- MF Machos de máquina Entrada en hélice

- MF Machine Tap Spiral Point

EP10	▪	1.1	1.2	1.3	1.4	1.5	6.1	6.3	7.1	7.2	7.3	7.4
	•	1.6	3.1	3.2	3.3	3.4	4.1	4.2	5.1	5.2	6.2	8.1
EP10TIN	▪	1.1	1.2	1.3	1.4	1.5	2.1	2.2	6.1	6.3	7.3	7.4
	•	1.6	2.3	3.1	3.2	3.3	3.4	4.1	4.2	5.1	5.2	6.2
EP11	▪	1.1	1.2	1.3	1.4	1.5						
	•	1.6	2.1	2.2	2.3	3.1	3.2	3.3	3.4			

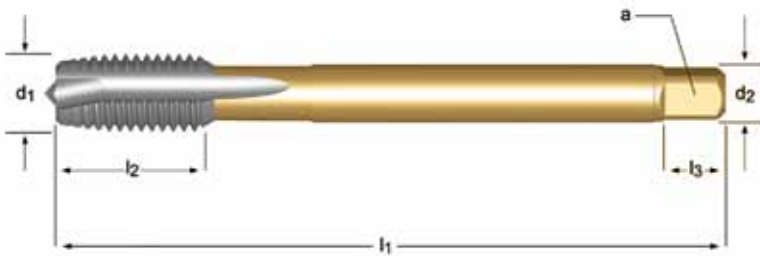

MF	P mm	l ₁ mm	l ₂ mm	d ₂ Ø mm	□ a mm	l ₃ mm	z		EP10	EP10TIN	EP11
4	0.50	63	12	2.8	2.1	5	3	3.5	EP10M4X.5		EP11M4X.5
5	0.50	70	13	3.5	2.7	6	3	4.5	EP10M5X.5		EP11M5X.5
6	0.75	80	15	4.5	3.4	6	3	5.3	EP10M6X.75		EP11M6X.75
8	0.75	80	15	6.0	4.9	8	3	7.3	EP10M8X.75		EP11M8X.75
8	1.00	90	18	6.0	4.9	8	3	7	EP10M8X1.0	EP10TINM8X1.0	EP11M8X1.0
10	0.75	90	18	7.0	5.5	8	3	9.3	EP10M10X.75		EP11M10X.75
10	1.00	90	18	7.0	5.5	8	3	9	EP10M10X1.0	EP10TINM10X1.0	EP11M10X1.0
10	1.25	100	20	7.0	5.5	8	3	8.8	EP10M10X1.25	EP10TINM10X1.25	EP11M10X1.25
12	1.00	100	21	9.0	7.0	10	3	11	EP10M12X1.0	EP10TINM12X1.0	EP11M12X1.0
12	1.25	100	21	9.0	7.0	10	3	10.8	EP10M12X1.25	EP10TINM12X1.25	EP11M12X1.25
12	1.50	100	21	9.0	7.0	10	3	10.5	EP10M12X1.5	EP10TINM12X1.5	EP11M12X1.5
14	1.00	100	21	11.0	9.0	12	3	13	EP10M14X1.0		EP11M14X1.0
14	1.25	100	21	11.0	9.0	12	3	13	EP10M14X1.25		EP11M14X1.25
14	1.50	100	21	11.0	9.0	12	3	12.5	EP10M14X1.5	EP10TINM14X1.5	EP11M14X1.5
16	1.00	100	21	12.0	9.0	12	3	15	EP10M16X1.0		EP11M16X1.0
16	1.50	100	21	12.0	9.0	12	3	14.5	EP10M16X1.5	EP10TINM16X1.5	EP11M16X1.5
18	1.00	110	24	14.0	11.0	14	4	17	EP10M18X1.0		EP11M18X1.0
18	1.50	110	24	14.0	11.0	14	4	16.5	EP10M18X1.5	EP10TINM18X1.5	EP11M18X1.5
20	1.00	125	24	16.0	12.0	15	4	19	EP10M20X1.0		EP11M20X1.0
20	1.50	125	24	16.0	12.0	15	4	18.5	EP10M20X1.5	EP10TINM20X1.5	EP11M20X1.5

MF	P mm	l ₁ mm	l ₂ mm	d ₂ ∅ mm	a mm	l ₃ mm	z		EP10	EP10TIN	EP11
22	1.50	125	25	18.0	14.5	17	4	20.5	EP10M22X1.5		EP11M22X1.5
24	1.50	140	28	18.0	14.5	17	4	22.5	EP10M24X1.5		EP11M24X1.5
24	2.00	140	28	18.0	14.5	17	4	22	EP10M24X2.0		EP11M24X2.0
25	1.50	140	28	18.0	14.5	17	4	23.5	EP10M25X1.5		EP11M25X1.5
26	1.50	140	28	18.0	14.5	17	4	24.5	EP10M26X1.5		EP11M26X1.5
27	1.50	140	28	20.0	16.0	19	4	25.5	EP10M27X1.5		EP11M27X1.5
27	2.00	140	28	20.0	16.0	19	4	25	EP10M27X2.0		EP11M27X2.0
28	1.50	140	28	20.0	16.0	19	4	26.5	EP10M28X1.5		EP11M28X1.5
30	1.50	150	28	22.0	18.0	21	4	28.5	EP10M30X1.5		EP11M30X1.5
30	2.00	150	28	22.0	18.0	21	4	28	EP10M30X2.0		EP11M30X2.0

E299

MF

DIN
374

6H



2.5XD

HSS-E
PM

B
3.5-5



- MF 机用螺尖丝锥，黄圈鲨鱼丝锥
- MF Macho Máquina Ponta Helicoidal, Shark - Anel Amarelo
- MF Macho de máquina con entrada en hélice Shark (Anillo Amarillo)
- MF Machine Tap Spiral Point, Yellow Shark

提供HSS-E，直到新的可用库存
Fornecido em HSS-E até disponibilidade do novo estoque
Suministrado en HSS-E hasta disponibilidad de nuevo stock
Supplied in HSS-E until new stock available

E299

E299	■	1.1	1.2	1.3	6.1	6.3
	•	1.4	1.5	6.2		

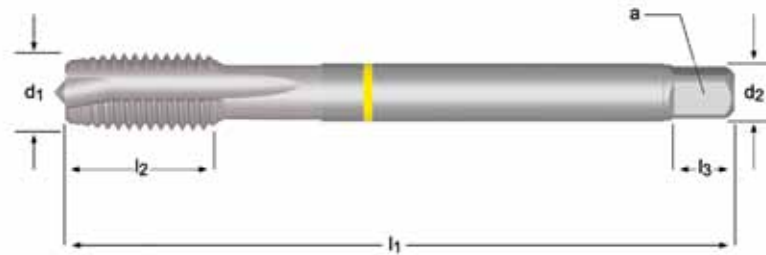

MF	P mm	l ₁ mm	l ₂ mm	d ₂ ∅ mm	∠ a mm	l ₃ mm	z		E299
4	0.50	63	12	2.8	2.1	5	3	3.5	E299M4X.5
5	0.50	70	13	3.5	2.7	6	3	4.5	E299M5X.5
6	0.75	80	15	4.5	3.4	6	3	5.3	E299M6X.75
8	0.75	80	15	6.0	4.9	8	3	7.3	E299M8X.75
8	1.00	90	18	6.0	4.9	8	3	7.0	E299M8X1.0
10	0.75	90	20	7.0	5.5	8	3	9.3	E299M10X.75
10	1.00	90	20	7.0	5.5	8	3	9.0	E299M10X1.0
10	1.25	100	20	7.0	5.5	8	3	8.8	E299M10X1.25
12	1.00	100	21	9.0	7.0	10	4	11.0	E299M12X1.0
12	1.25	100	21	9.0	7.0	10	4	10.8	E299M12X1.25
12	1.50	110	21	9.0	7.0	10	4	10.5	E299M12X1.5
14	1.00	100	21	11.0	9.0	12	4	13.0	E299M14X1.0
14	1.25	100	21	11.0	9.0	12	4	12.8	E299M14X1.25
14	1.50	100	21	11.0	9.0	12	4	12.5	E299M14X1.5
16	1.00	100	21	12.0	9.0	12	4	15.0	E299M16X1.0
16	1.50	100	21	12.0	9.0	12	4	14.5	E299M16X1.5
18	1.00	110	24	14.0	11.0	14	4	17.0	E299M18X1.0
18	1.50	110	24	14.0	11.0	14	4	16.5	E299M18X1.5
20	1.50	125	24	16.0	12.0	15	4	18.5	E299M20X1.5
22	1.50	125	25	18.0	14.5	17	4	20.5	E299M22X1.5
24	1.50	140	28	18.0	14.5	17	4	22.5	E299M24X1.5
24	2.00	140	28	18.0	14.5	17	4	22.0	E299M24X2.0
27	2.00	140	28	20.0	16.0	19	4	25.0	E299M27X2.0
30	2.00	150	28	22.0	18.0	21	4	28.0	E299M30X2.0

E384

MF

DIN
374

6H



2.5XD

HSS-E
PM

B
3.5-5



E384

- MF 机用螺尖丝锥，蓝圈鲨鱼丝锥
- MF Macho Máquina Ponta Helicoidal Shark - Anel Azul
- MF Macho de máquina con entrada en hélice Shark (Anillo Azul)
- MF Machine Tap Spiral Point, Blue Shark

提供HSS-E，直到新的可用库存

Fornecido em HSS-E até disponibilidade do novo estoque

Suministrado en HSS-E hasta disponibilidad de nuevo stock

Supplied in HSS-E until new stock available

E384	▪	2.1	2.2	2.3
	•	1.5	1.6	



MF	P mm	l_1 mm	l_2 mm	d_2 Ø mm	\square a mm	l_3 mm	z		E384
6	0.75	80	15	4.5	3.4	6	3	5.3	E384M6X.75
8	1.00	90	18	6.0	4.9	8	3	7.0	E384M8X1.0
10	1.00	90	20	7.0	5.5	8	3	9.0	E384M10X1.0
10	1.25	100	20	7.0	5.5	8	3	8.8	E384M10X1.25
12	1.00	100	21	9.0	7.0	10	4	11.0	E384M12X1.0
12	1.25	100	21	9.0	7.0	10	4	10.8	E384M12X1.25
12	1.50	100	21	9.0	7.0	10	4	10.5	E384M12X1.5
14	1.50	100	21	11.0	9.0	12	4	12.5	E384M14X1.5
16	1.50	100	21	12.0	9.0	12	5	14.5	E384M16X1.5
18	1.50	110	24	14.0	11.0	14	5	16.5	E384M18X1.5
20	1.50	125	24	16.0	12.0	15	5	18.5	E384M20X1.5

E011

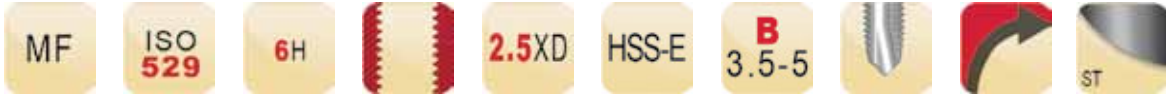

- MF 机用丝锥 螺尖
- MF Macho Máquina Ponta Helicoidal
- MF Machos de máquina Entrada en hélice
- MF Machine Tap Spiral Point

E011

E011	▪	1.1	1.2	1.3	1.4	1.5				
	•	1.6	2.1	2.2	2.3	3.1	3.2	3.3	3.4	

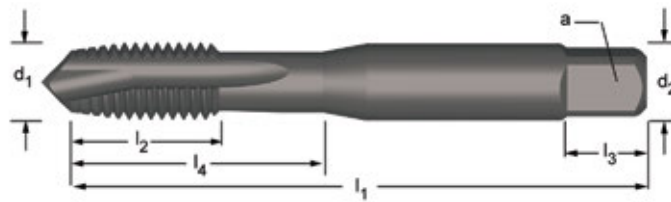

MF	P mm	l ₁ mm	l ₂ mm	d ₂ Ø mm	□ a mm	l ₃ mm	z		l ₄ mm	E011
4	0.50	53	17	4.0	3.15	6	3	3.5	17	E011M4X.5
5	0.50	58	11	5.0	4.00	7	3	4.5	22	E011M5X.5
6	0.50	66	13	6.3	5.00	8	3	5.5	26	E011M6X.5
6	0.75	66	13	6.3	5.00	8	3	5.3	26	E011M6X.75
8	0.75	72	16	8.0	6.30	9	3	7.3	29	E011M8X.75
8	1.00	72	16	8.0	6.30	9	3	7.0	29	E011M8X1.0
10	1.00	80	18	10.0	8.00	11	3	9.0	34	E011M10X1.0
10	1.25	80	18	10.0	8.00	11	3	8.8	34	E011M10X1.25
12	1.00	89	22	9.0	7.10	10	3	11.0	-	E011M12X1.0
12	1.25	89	22	9.0	7.10	10	3	10.8	-	E011M12X1.25
12	1.50	89	22	9.0	7.10	10	3	10.5	-	E011M12X1.5
14	1.00	95	24	11.2	9.00	12	3	13.0	-	E011M14X1.0
14	1.25	95	24	11.2	9.00	12	3	12.8	-	E011M14X1.25
14	1.50	95	24	11.2	9.00	12	3	12.5	-	E011M14X1.5
16	1.00	102	24	12.5	10.00	13	3	15.0	-	E011M16X1.0
16	1.50	102	24	12.5	10.00	13	3	14.5	-	E011M16X1.5
18	1.00	112	29	14.0	11.20	14	4	17.0	-	E011M18X1.0
18	1.50	112	29	14.0	11.20	14	4	16.5	-	E011M18X1.5
20	1.00	112	29	14.0	11.20	14	4	19.0	-	E011M20X1.0
20	1.50	112	29	14.0	11.20	14	4	18.5	-	E011M20X1.5
20	2.00	112	29	14.0	11.20	14	4	18.0	-	E011M20X2.0
22	1.50	118	29	16.0	12.50	16	4	20.5	-	E011M22X1.5
24	1.50	130	35	18.0	14.00	18	4	22.5	-	E011M24X1.5
24	2.00	130	35	18.0	14.00	18	4	22.0	-	E011M24X2.0



EX10

- MF 机用丝锥 螺旋槽 45°

EX10TIN

- MF Macho Máquina Canal Helicoidal 45°

EX11

- MF Machos de máquina Estrías helicoidales a 45°

- MF Machine Tap Spiral Flute 45°

EX10	▪	1.1	1.2	1.3	1.4	1.5	7.1	7.2	7.3	7.4
	•	4.1	4.2	5.1	5.2					
EX10TIN	▪	1.1	1.2	1.3	1.4	1.5	2.1	2.2	7.3	7.4
	•	2.3	3.1	3.2	3.3	3.4	4.1	4.2	5.1	5.2
EX11	▪	1.1	1.2	1.3	1.4	1.5	2.1	2.2		
	•	2.3								

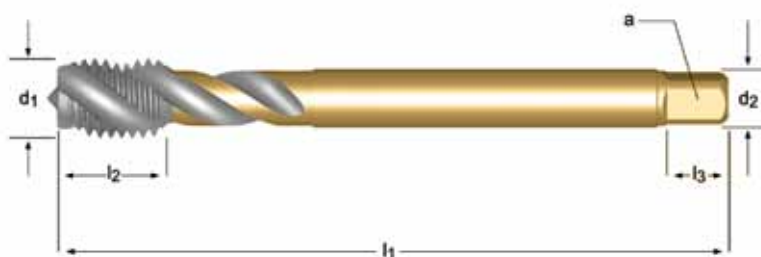

MF	P mm	l ₁ mm	l ₂ mm	d ₂ Ø mm	□ a mm	l ₃ mm	z		EX10	EX10TIN	EX11
4	0.50	63	7	2.8	2.1	5	3	3.5	EX10M4X.50		EX11M4X.50
5	0.50	70	8	3.5	2.7	6	3	4.5	EX10M5X.50		EX11M5X.50
6	0.75	80	10	4.5	3.4	6	3	5.3	EX10M6X.75		EX11M6X.75
8	0.75	80	13	6.0	4.9	8	3	7.3	EX10M8X.75		EX11M8X.75
8	1.00	90	13	6.0	4.9	8	3	7	EX10M8X1.0	EX10TINM8X1.0	EX11M8X1.0
10	0.75	90	13	7.0	5.5	8	3	9.3	EX10M10X.75		EX11M10X.75
10	1.00	90	13	7.0	5.5	8	3	9	EX10M10X1.0	EX10TINM10X1.0	EX11M10X1.0
10	1.25	100	15	7.0	5.5	8	3	8.8	EX10M10X1.25	EX10TINM10X1.25	EX11M10X1.25
12	1.00	100	15	9.0	7.0	10	3	11	EX10M12X1.0	EX10TINM12X1.0	EX11M12X1.0
12	1.25	100	15	9.0	7.0	10	3	10.8	EX10M12X1.25	EX10TINM12X1.25	EX11M12X1.25
12	1.50	100	15	9.0	7.0	10	3	10.5	EX10M12X1.5	EX10TINM12X1.5	EX11M12X1.5
14	1.00	100	15	11.0	9.0	12	3	13	EX10M14X1.0		EX11M14X1.0
14	1.25	100	15	11.0	9.0	12	3	12.8	EX10M14X1.25		EX11M14X1.25
14	1.50	100	15	11.0	9.0	12	3	12.5	EX10M14X1.5	EX10TINM14X1.5	EX11M14X1.5
16	1.00	100	15	12.0	9.0	12	4	15	EX10M16X1.0		EX11M16X1.0
16	1.50	100	15	12.0	9.0	12	4	14.5	EX10M16X1.5	EX10TINM16X1.5	EX11M16X1.5
18	1.00	110	17	14.0	11.0	14	4	17	EX10M18X1.0		EX11M18X1.0
18	1.50	110	17	14.0	11.0	14	4	16.5	EX10M18X1.5	EX10TINM18X1.5	EX11M18X1.5
20	1.00	125	17	16.0	12.0	15	4	19	EX10M20X1.0		EX11M20X1.0
20	1.50	125	17	16.0	12.0	15	4	18.5	EX10M20X1.5	EX10TINM20X1.5	EX11M20X1.5

MF	P mm	l ₁ mm	l ₂ mm	d ₂ ∅ mm	□ a mm	l ₃ mm	z		EX10	EX10TIN	EX11
22	1.50	125	17	18.0	14.5	17	4	20.5	EX10M22X1.5		EX11M22X1.5
24	1.50	140	20	18.0	14.5	17	4	22.5	EX10M24X1.5		EX11M24X1.5
24	2.00	140	20	18.0	14.5	17	4	22	EX10M24X2.0		EX11M24X2.0
25	1.50	140	20	18.0	14.5	17	4	23.5	EX10M25X1.5		EX11M25X1.5
26	1.50	140	20	18.0	14.5	17	4	24.5	EX10M26X1.5		EX11M26X1.5
27	1.50	140	20	20.0	16.0	19	4	25.5	EX10M27X1.5		EX11M27X1.5
27	2.00	140	20	20.0	16.0	19	4	25	EX10M27X2.0		EX11M27X2.0
28	1.50	140	20	20.0	16.0	19	4	26.5	EX10M28X1.5		EX11M28X1.5
30	1.50	150	20	22.0	18.0	21	4	28.5	EX10M30X1.5		EX11M30X1.5
30	2.00	150	20	22.0	18.0	21	4	28	EX10M30X2.0		EX11M30X2.0

E300

MF

DIN
374

6H



2XD

HSS-E
PM

C
2-3



- MF 机用细牙螺旋槽40°丝锥，黄圈鲨鱼丝锥
- MF Macho Máquina Canal Helicoidal 40°, Shark - Anel Amarelo
- MF Macho de máquina helicoidal 40° Shark (Anillo Amarillo)
- MF Machine Tap Spiral Flute 40°, Yellow Shark

提供HSS-E，直到新的可用库存

Fornecido em HSS-E até disponibilidade do novo estoque

Suministrado en HSS-E hasta disponibilidad de nuevo stock

Supplied in HSS-E until new stock available

E300

- E300 ■ 1.1 1.2 1.3 6.1 6.3
 • 1.4 1.5 6.2

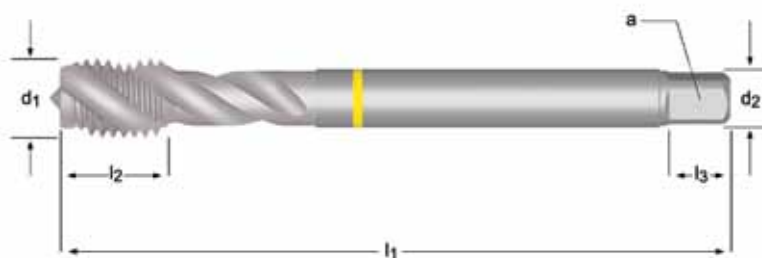

E300



SHARK LINE

M4 - M30

MF	P mm	l_1 mm	l_2 mm	d_2 Ø mm	\square a mm	l_3 mm	z		E300
4	0.50	63	6.5	2.8	2.1	5	3	3.5	E300M4X.5
5	0.50	70	7.5	3.5	2.7	6	3	4.5	E300M5X.5
6	0.75	80	10	4.5	3.4	6	3	5.3	E300M6X.75
8	0.75	80	13	6.0	4.9	8	3	7.3	E300M8X.75
8	1.00	90	13	6.0	4.9	8	3	7.0	E300M8X1.0
10	0.75	90	13	7.0	5.5	8	3	9.3	E300M10X.75
10	1.00	90	12	7.0	5.5	8	3	9.0	E300M10X1.0
10	1.25	100	15	7.0	5.5	8	3	8.8	E300M10X1.25
12	1.00	100	15	9.0	7.0	10	4	11.0	E300M12X1.0
12	1.25	100	13	9.0	7.0	10	4	10.8	E300M12X1.25
12	1.50	100	13	9.0	7.0	10	4	10.5	E300M12X1.5
14	1.00	100	15	11.0	9.0	12	4	13.0	E300M14X1.0
14	1.25	100	15	11.0	9.0	12	4	12.8	E300M14X1.25
14	1.50	100	15	11.0	9.0	12	4	12.5	E300M14X1.5
16	1.00	100	15	12.0	9.0	12	5	15.0	E300M16X1.0
16	1.50	100	15	12.0	9.0	12	5	14.5	E300M16X1.5
18	1.00	110	17	14.0	11.0	14	5	17.0	E300M18X1.0
18	1.50	110	17	14.0	11.0	14	5	16.5	E300M18X1.5
20	1.50	125	17	16.0	12.0	15	5	18.5	E300M20X1.5
22	1.50	125	17	18.0	14.5	17	5	20.5	E300M22X1.5
24	1.50	140	20	18.0	14.5	17	5	22.5	E300M24X1.5
24	2.00	140	20	18.0	14.5	17	5	22.0	E300M24X2.0
27	2.00	140	20	20.0	16.0	19	5	25.0	E300M27X2.0
30	2.00	150	20	22.0	18.0	21	5	28.0	E300M30X2.0

E383



E383

- MF 机用细牙螺旋槽40°丝锥，蓝圈鲨鱼丝锥
- MF Macho Máquina Canal Helicoidal 40° Shark - Anel Azul
- MF Macho de máquina helicoidal 40° Shark (Anillo Azul)
- MF Machine Tap Spiral Flute 40°, Blue Shark

提供HSS-E，直到新的可用库存
 Fornecido em HSS-E até disponibilidade do novo estoque
 Suministrado en HSS-E hasta disponibilidad de nuevo stock
 Supplied in HSS-E until new stock available

E383	▪	2.1	2.2	2.3
	•	1.5	1.6	



MF	P mm	l_1 mm	l_2 mm	d_2 Ø mm	\square a mm	l_3 mm	z		E383
6	0.75	80	10	4.5	3.4	6	3	5.3	E383M6X.75
8	1.00	90	13	6.0	4.9	8	3	7.0	E383M8X1.0
10	1.00	90	12	7.0	5.5	8	3	9.0	E383M10X1.0
10	1.25	100	15	7.0	5.5	8	3	8.8	E383M10X1.25
12	1.00	100	13	9.0	7.0	10	4	11.0	E383M12X1.0
12	1.25	100	13	9.0	7.0	10	4	10.8	E383M12X1.25
12	1.50	100	13	9.0	7.0	10	4	10.5	E383M12X1.5
14	1.50	100	21	11.0	9.0	12	4	12.5	E383M14X1.5
16	1.50	100	21	12.0	9.0	12	5	14.5	E383M16X1.5
18	1.50	110	24	14.0	11.0	14	5	16.5	E383M18X1.5
20	1.50	125	24	16.0	12.0	15	5	18.5	E383M20X1.5

E013

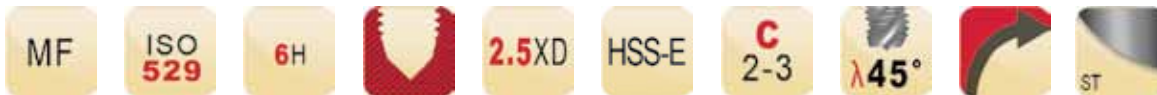

- MF 机用丝锥 螺旋槽 45°
- MF Macho Máquina Canal Helicoidal 45°
- MF Machos de máquina Estrías helicoidales a 45°
- MF Machine Tap Spiral Flute 45°

E013

E013	▪	1.1	1.2	1.3	1.4	1.5
	•	2.1	2.2	2.3		

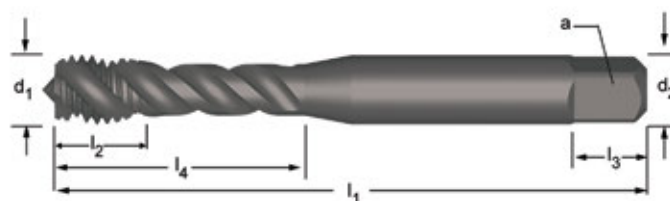

MF	P mm	l ₁ mm	l ₂ mm	d ₂ ∅ mm	□ a mm	l ₃ mm	z	↔	l ₄ mm	E013
4	0.50	53	7	4.0	3.15	6	3	3.5	19	E013M4X.5
5	0.50	58	8	5.0	4.0	7	3	4.5	22	E013M5X.5
6	0.50	66	10	6.3	5.0	8	3	5.5	27	E013M6X.5
6	0.75	66	10	6.3	5.0	8	3	5.3	27	E013M6X.75
8	0.75	72	12	8.0	6.3	9	3	7.3	31	E013M8X.75
8	1.00	72	12	8.0	6.3	9	3	7.0	31	E013M8X1.0
10	1.00	80	15	10.0	8.0	11	3	9.0	35	E013M10X1.0
10	1.25	80	15	10.0	8.0	11	3	8.8	35	E013M10X1.25
12	1.00	89	16	9.0	7.1	10	3	11.0	-	E013M12X1.0
12	1.25	89	16	9.0	7.1	10	3	10.8	-	E013M12X1.25
12	1.50	89	16	9.0	7.1	10	3	10.5	-	E013M12X1.5
14	1.50	95	18	11.2	9.0	12	3	12.5	-	E013M14X1.5
16	1.00	102	18	12.5	10.0	13	4	15.0	-	E013M16X1.0
16	1.50	102	18	12.5	10.0	13	4	14.5	-	E013M16X1.5
18	1.50	112	29	14.0	11.2	14	4	16.5	-	E013M18X1.5
20	1.50	112	29	14.0	11.2	14	4	18.5	-	E013M20X1.5
22	1.50	118	29	16.0	12.5	16	4	20.5	-	E013M22X1.5

E108

UNC

DIN
352

2B



1.5XD

HSS

C
2-3



- UNC 手动丝锥 直槽
- UNC Macho Manual Canal Reto
- UNC Machos de mano Estrias rectas
- UNC Hand Tap Straight Flute

E108

E108 • 1.1 1.2 1.3 1.4 1.5 3.1 3.2 3.3 3.4 6.1 6.2 6.3 6.4 7.2 7.3 7.4 8.2 8.3

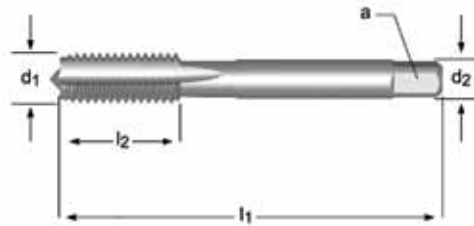

E108



No.5 - 1"

UNC	TPI	d ₁ nom mm	l ₁ mm	l ₂ mm	d ₂ Ø mm	□ a mm	z		E108
5	40	3.18	45	13	4.0	3.0	3	2.65	E1085-40NO3
5	40	3.18	45	13	4.0	3.0	3	2.65	E1085-40NO8
6	32	3.51	45	10	4.0	3.0	3	2.85	E1086-32NO3
6	32	3.51	45	10	4.0	3.0	3	2.85	E1086-32NO8
8	32	4.17	50	14	6.0	4.9	3	3.5	E1088-32NO3
8	32	4.17	50	14	6.0	4.9	3	3.5	E1088-32NO8
10	24	4.83	50	14	6.0	4.9	3	3.9	E10810-24NO3
10	24	4.83	50	14	6.0	4.9	3	3.9	E10810-24NO8
12	24	5.49	56	16	6.0	4.9	3	4.5	E10812-24NO3
12	24	5.49	56	16	6.0	4.9	3	4.5	E10812-24NO8
1/4	20	6.35	56	17	6.0	4.9	3	5.1	E1081/4NO3
1/4	20	6.35	56	17	6.0	4.9	3	5.1	E1081/4NO8
5/16	18	7.94	63	19	6.0	4.9	3	6.6	E1085/16NO3
5/16	18	7.94	63	19	6.0	4.9	3	6.6	E1085/16NO8
3/8	16	9.53	70	22	7.0	5.5	3	8	E1083/8NO3
3/8	16	9.53	70	22	7.0	5.5	3	8	E1083/8NO8
7/16	14	11.11	75	30	8.0	6.2	3	9.4	E1087/16NO3
7/16	14	11.11	75	30	8.0	6.2	3	9.4	E1087/16NO8
1/2	13	12.70	75	27	9.0	7.0	3	10.8	E1081/2NO3
1/2	13	12.70	75	27	9.0	7.0	3	10.8	E1081/2NO8
9/16	12	14.29	80	30	11.0	9.0	4	12.2	E1089/16NO3
9/16	12	14.29	80	30	11.0	9.0	4	12.2	E1089/16NO8
5/8	11	15.88	80	32	12.0	9.0	4	13.5	E1085/8NO3
5/8	11	15.88	80	32	12.0	9.0	4	13.5	E1085/8NO8
3/4	10	19.05	95	34	14.0	11.0	4	16.5	E1083/4NO3
3/4	10	19.05	95	34	14.0	11.0	4	16.5	E1083/4NO8
7/8	9	22.23	110	38	18.0	14.5	4	19.5	E1087/8NO3
7/8	9	22.23	110	38	18.0	14.5	4	19.5	E1087/8NO8
1"	8	25.40	110	38	20.0	16.0	4	22.25	E1081NO8

NO1
NO9
198



- E225**
- UNC 机用丝锥 直槽
 - UNC Macho Máquina Canal Reto
- E275**
- UNC MMachos de máquina Estrías rectas
 - UNC Machine Tap Straight Flute

E225; E275 • 1.1 1.2 1.3 1.4 1.5 3.1 3.2 3.3 6.2 6.3 7.2 7.3 8.2

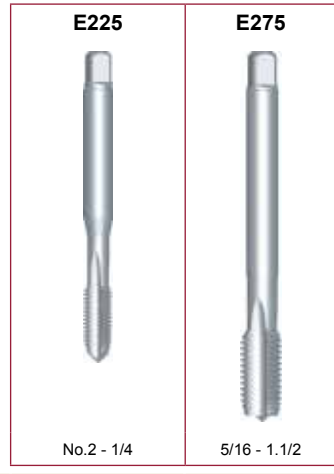
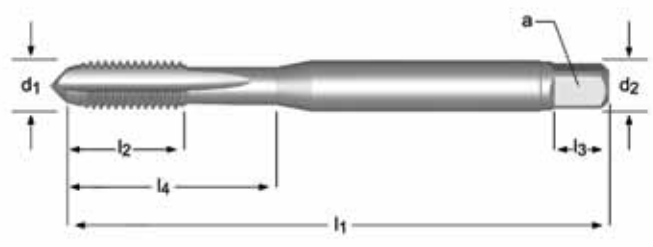

UNC	TPI	d ₁ nom mm	l ₁ mm	l ₂ mm	d ₂ ∅ mm	□ a mm	l ₃ mm	z	↔	l ₄ mm	E225	E275
2	56	2.184	45	7	2.8	2.1	5	3	1.9	12	E2252-56	
3	48	2.515	50	8	2.8	2.1	5	3	2.1	12.5	E2253-48NO3	
4	40	2.845	56	9	3.5	2.7	6	3	2.35	18	E2254-40	
5	40	3.175	56	10	3.5	2.7	6	3	2.65	18	E2255-40	
6	32	3.505	56	11	4.0	3.0	6	3	2.85	20	E2256-32	
8	32	4.166	63	12	4.5	3.4	8	3	3.5	21	E2258-32	
10	24	4.826	70	13	6.0	4.9	8	3	3.9	25	E22510-24	
12	24	5.486	80	15	6.0	4.9	8	3	4.5	30	E22512-24	
1/4	20	6.350	80	16	7.0	5.5	8	3	5.1	30	E2251/4	
5/16	18	7.94	90	18	6.0	4.9	8	3	6.6	-		E2755/16
3/8	16	9.53	100	24	7.0	5.5	8	3	8.0	-		E2753/8
7/16	14	11.11	110	23	9.0	7.0	10	3	9.4	-		E2757/16
1/2	13	12.7	110	23	9.0	7.0	10	3	10.8	-		E2751/2
9/16	12	14.29	110	25	11.0	9.0	12	3	12.2	-		E2759/16
5/8	11	15.88	110	25	12.0	9.0	12	4	13.5	-		E2755/8
3/4	10	19.05	140	34	14.0	11.0	14	4	16.5	-		E2753/4
7/8	9	22.23	140	34	18.0	14.5	17	4	19.5	-		E2757/8
1"	8	25.40	160	38	20.0	16.0	19	4	22.25	-		E2751
1.1/8	7	28.58	180	45	22.0	18.0	21	4	25.0	-		E2751.1/8
1.1/4	7	31.75	180	50	25.0	20.0	23	4	28.0	-		E2751.1/4
1.1/2	6	38.10	200	60	32.0	24.0	27	4	34.0	-		E2751.1/2

E515

UNC

ISO
529

2B



1.5XD

HSS



L120
309

- UNC 机用丝锥 直槽
- UNC Macho Máquina Canal Reto
- UNC MMachos de máquina Estrías rectas
- UNC Machine Tap Straight Flute

E515

E515 • 1.1 1.2 1.3 1.4 1.5 3.1 3.2 3.3 3.4 6.1 6.2 6.3 6.4 7.2 7.3 7.4 8.2 8.3

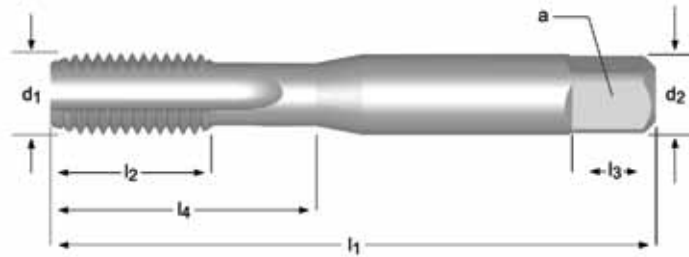

E515



No.1 - 2"

UNC	TPI	d ₁ nom mm	l ₁ mm	l ₂ mm	d ₂ Ø mm	∠ a mm	l ₃ mm	z		l ₄ mm	E515
1	64	1.854	41	8	2.50	2.00	4	2	1.55	8	E5151-64NO1
1	64	1.854	41	8	2.50	2.00	4	2	1.55	8	E5151-64NO2
1	64	1.854	41	8	2.50	2.00	4	2	1.55	8	E5151-64NO3
1	64	1.854	41	8	2.50	2.00	4	2	1.55	8	E5151-64NO6
2	56	2.184	44.5	9.5	2.80	2.24	5	3	1.85	9.5	E5152-56NO1
2	56	2.184	44.5	9.5	2.80	2.24	5	3	1.85	9.5	E5152-56NO2
2	56	2.184	44.5	9.5	2.80	2.24	5	3	1.85	9.5	E5152-56NO3
2	56	2.184	44.5	9.5	2.80	2.24	5	3	1.85	9.5	E5152-56NO6
3	48	2.515	44.5	9.5	2.80	2.24	5	3	2.1	9.5	E5153-48NO1
3	48	2.515	44.5	9.5	2.80	2.24	5	3	2.1	9.5	E5153-48NO2
3	48	2.515	44.5	9.5	2.80	2.24	5	3	2.1	9.5	E5153-48NO3
3	48	2.515	44.5	9.5	2.80	2.24	5	3	2.1	9.5	E5153-48NO6
4	40	2.845	48	12.5	3.15	2.50	5	3	2.35	12.5	E5154-40NO1
4	40	2.845	48	12.5	3.15	2.50	5	3	2.35	12.5	E5154-40NO2
4	40	2.845	48	12.5	3.15	2.50	5	3	2.35	12.5	E5154-40NO3
4	40	2.845	48	12.5	3.15	2.50	5	3	2.35	12.5	E5154-40NO6
5	40	3.175	48	12.5	3.15	2.50	5	3	2.65	12.5	E5155-40NO1
5	40	3.175	48	12.5	3.15	2.50	5	3	2.65	12.5	E5155-40NO2
5	40	3.175	48	12.5	3.15	2.50	5	3	2.65	12.5	E5155-40NO3
5	40	3.175	48	12.5	3.15	2.50	5	3	2.65	12.5	E5155-40NO6
6	32	3.505	50	14	3.55	2.80	5	3	2.85	14	E5156-32NO1
6	32	3.505	50	14	3.55	2.80	5	3	2.85	14	E5156-32NO2
6	32	3.505	50	14	3.55	2.80	5	3	2.85	14	E5156-32NO3
6	32	3.505	50	14	3.55	2.80	5	3	2.85	14	E5156-32NO6
8	32	4.166	53	9.5	4.50	3.55	6	3	3.5	17	E5158-32NO1
8	32	4.166	53	9.5	4.50	3.55	6	3	3.5	17	E5158-32NO2
8	32	4.166	53	9.5	4.50	3.55	6	3	3.5	17	E5158-32NO3
8	32	4.166	53	9.5	4.50	3.55	6	3	3.5	17	E5158-32NO6
10	24	4.826	58	11	5.00	4.00	7	3	3.9	20	E51510-24NO1
10	24	4.826	58	11	5.00	4.00	7	3	3.9	20	E51510-24NO2
10	24	4.826	58	11	5.00	4.00	7	3	3.9	20	E51510-24NO3
10	24	4.826	58	11	5.00	4.00	7	3	3.9	20	E51510-24NO6
12	24	5.486	62	12	5.60	4.50	7	3	4.5	21	E51512-24NO1
12	24	5.486	62	12	5.60	4.50	7	3	4.5	21	E51512-24NO2
12	24	5.486	62	12	5.60	4.50	7	3	4.5	21	E51512-24NO3
12	24	5.486	62	12	5.60	4.50	7	3	4.5	21	E51512-24NO6
1/4	20	6.350	66	13	6.30	5.00	8	3	5.1	26	E51514NO1
1/4	20	6.350	66	13	6.30	5.00	8	3	5.1	26	E51514NO2

UNC	TPI	d ₁ nom mm	l ₁ mm	l ₂ mm	d ₂ Ø mm	□ a mm	l ₃ mm	z		l ₄ mm	E515
1/4	20	6.350	66	13	6.30	5.00	8	3	5.1	26	E5151/4NO3
1/4	20	6.350	66	13	6.30	5.00	8	3	5.1	26	E5151/4NO6
5/16	18	7.938	72	16	8.00	6.30	9	3	6.6	29	E5155/16NO1
5/16	18	7.938	72	16	8.00	6.30	9	3	6.6	29	E5155/16NO2
5/16	18	7.938	72	16	8.00	6.30	9	3	6.6	29	E5155/16NO3
5/16	18	7.938	72	16	8.00	6.30	9	3	6.6	29	E5155/16NO6
3/8	16	9.525	80	18	10.00	8.00	11	3	8	32	E5153/8NO1
3/8	16	9.525	80	18	10.00	8.00	11	3	8	32	E5153/8NO2
3/8	16	9.525	80	18	10.00	8.00	11	3	8	32	E5153/8NO3
3/8	16	9.525	80	18	10.00	8.00	11	3	8	32	E5153/8NO6
7/16	14	11.112	85	19	8.00	6.30	9	3	9.4	-	E5157/16NO1
7/16	14	11.112	85	19	8.00	6.30	9	3	9.4	-	E5157/16NO2
7/16	14	11.112	85	19	8.00	6.30	9	3	9.4	-	E5157/16NO3
7/16	14	11.112	85	19	8.00	6.30	9	3	9.4	-	E5157/16NO6
1/2	13	12.700	89	22	9.00	7.10	10	3	10.8	-	E5151/2NO1
1/2	13	12.700	89	22	9.00	7.10	10	3	10.8	-	E5151/2NO2
1/2	13	12.700	89	22	9.00	7.10	10	3	10.8	-	E5151/2NO3
1/2	13	12.700	89	22	9.00	7.10	10	3	10.8	-	E5151/2NO6
9/16	12	14.288	95	24	11.20	9.00	12	4	12.2	-	E5159/16NO1
9/16	12	14.288	95	24	11.20	9.00	12	4	12.2	-	E5159/16NO2
9/16	12	14.288	95	24	11.20	9.00	12	4	12.2	-	E5159/16NO3
9/16	12	14.288	95	24	11.20	9.00	12	4	12.2	-	E5159/16NO6
5/8	11	15.875	102	24	12.50	10.00	13	4	13.5	-	E5155/8NO1
5/8	11	15.875	102	24	12.50	10.00	13	4	13.5	-	E5155/8NO2
5/8	11	15.875	102	24	12.50	10.00	13	4	13.5	-	E5155/8NO3
5/8	11	15.875	102	24	12.50	10.00	13	4	13.5	-	E5155/8NO6
3/4	10	19.050	112	29	14.00	11.20	14	4	16.5	-	E5153/4NO1
3/4	10	19.050	112	29	14.00	11.20	14	4	16.5	-	E5153/4NO2
3/4	10	19.050	112	29	14.00	11.20	14	4	16.5	-	E5153/4NO3
3/4	10	19.050	112	29	14.00	11.20	14	4	16.5	-	E5153/4NO6
7/8	9	22.225	118	29	16.00	12.50	16	4	19.5	-	E5157/8NO1
7/8	9	22.225	118	29	16.00	12.50	16	4	19.5	-	E5157/8NO2
7/8	9	22.225	118	29	16.00	12.50	16	4	19.5	-	E5157/8NO3
7/8	9	22.225	118	29	16.00	12.50	16	4	19.5	-	E5157/8NO6
1"	8	25.400	130	35	18.00	14.00	18	4	22.25	-	E5151NO3
1"	8	25.400	130	35	18.00	14.00	18	4	22.25	-	E5151NO1
1"	8	25.400	130	35	18.00	14.00	18	4	22.25	-	E5151NO2
1"	8	25.400	130	35	18.00	14.00	18	4	22.25	-	E5151NO6
1.1/8	7	28.575	138	35	20.00	16.00	20	4	25	-	E5151.1/8NO1
1.1/8	7	28.575	138	35	20.00	16.00	20	4	25	-	E5151.1/8NO2
1.1/8	7	28.575	138	35	20.00	16.00	20	4	25	-	E5151.1/8NO3
1.1/4	7	31.750	151	41	22.40	18.00	22	4	28	-	E5151.1/4NO1
1.1/4	7	31.750	151	41	22.40	18.00	22	4	28	-	E5151.1/4NO2
1.1/4	7	31.750	151	41	22.40	18.00	22	4	28	-	E5151.1/4NO3
1.3/8	6	34.925	162	47	25.00	20.00	24	4	30.75	-	E5151.3/8NO1
1.3/8	6	34.925	162	47	25.00	20.00	24	4	30.75	-	E5151.3/8NO2
1.3/8	6	34.925	162	47	25.00	20.00	24	4	30.75	-	E5151.3/8NO3
1.1/2	6	38.100	170	47	28.00	22.40	26	4	34	-	E5151.1/2NO1
1.1/2	6	38.100	170	47	28.00	22.40	26	4	34	-	E5151.1/2NO2
1.1/2	6	38.100	170	47	28.00	22.40	26	4	34	-	E5151.1/2NO3
1.3/4	5	44.450	187	54	31.50	25.00	28	6	39.5	-	E5151.3/4NO1
1.3/4	5	44.450	187	54	31.50	25.00	28	6	39.5	-	E5151.3/4NO2
1.3/4	5	44.450	187	54	31.50	25.00	28	6	39.5	-	E5151.3/4NO3
2"	4.5	50.800	200	60	35.50	28.00	31	6	45	-	E5152NO3
2"	4.5	50.800	200	60	35.50	28.00	31	6	45	-	E5152NO1
2"	4.5	50.800	200	60	35.50	28.00	31	6	45	-	E5152NO2



- EP20**
- UNC 机用丝锥 螺尖
 - UNC Macho Máquina Ponta Helicoidal
- EP21**
- UNC Machos de máquina Entrada en hélice
 - UNC Machine Tap Spiral Point

EP20	▪	1.1	1.2	1.3	1.4	1.5	6.1	6.3	7.1	7.2	7.3	7.4
	•	1.6	3.1	3.2	3.3	3.4	4.1	4.2	5.1	5.2	6.2	8.1
EP21	▪	1.1	1.2	1.3	1.4	1.5						
	•	1.6	2.1	2.2	2.3	3.1	3.2	3.3	3.4			

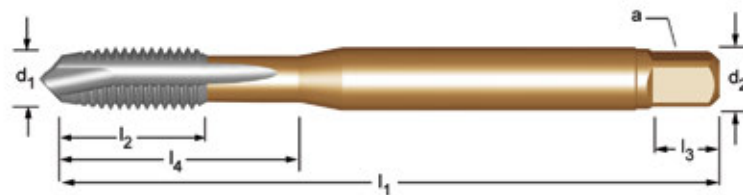

UNC	TPI	d ₁ nom mm	l ₁ mm	l ₂ mm	d ₂ Ø mm	□ a mm	l ₃ mm	z		l ₄ mm	EP20	EP21
4	40	2.845	56	9	3.5	2.7	6	3	2.35	18	EP204-40	EP214-40
5	40	3.175	56	10	3.5	2.7	6	3	2.65	18	EP205-40	EP215-40
6	32	3.505	56	11	4.0	3.0	6	3	2.85	20	EP206-32	EP216-32
8	32	4.166	63	12	4.5	3.4	8	3	3.5	21	EP208-32	EP218-32
10	24	4.826	70	13	6.0	4.9	8	3	3.9	25	EP210-24	EP2110-24
12	24	5.486	80	15	6.0	4.9	8	3	4.5	30	EP212-24	EP2112-24
1/4	20	6.350	80	15	7.0	5.5	8	3	5.1	30	EP201/4	EP211/4
5/16	18	7.938	90	18	8.0	6.2	9	3	6.6	35	EP205/16	EP215/16
3/8	16	9.525	100	20	10.0	8.0	11	3	8	39	EP203/8	EP213/8
7/16	14	11.112	100	20	8.0	6.2	9	3	9.4	-	EP207/16	EP217/16
1/2	13	12.700	110	23	9.0	7.0	10	3	10.8	-	EP201/2	EP211/2
5/8	11	15.875	110	25	12.0	9.0	12	3	13.5	-	EP205/8	EP215/8
3/4	10	19.050	125	30	14.0	11.0	14	4	16.5	-	EP203/4	EP213/4
7/8	9	22.225	140	34	18.0	14.5	17	4	19.5	-	EP207/8	EP217/8
1"	8	25.400	160	38	18.0	14.5	17	4	22.25	-	EP201	EP211

E021

UNC

ISO
529

2B



2.5XD

HSS-E

B
3.5-5



- UNC 机用丝锥 螺尖
- UNC Macho Máquina Ponta Helicoidal
- UNC Machos de máquina Entrada en hélice
- UNC Machine Tap Spiral Point

E021

E021

- 1.1 1.2 1.3 1.4 1.5
- 1.6 2.1 2.2 2.3 3.1 3.2 3.3 3.4

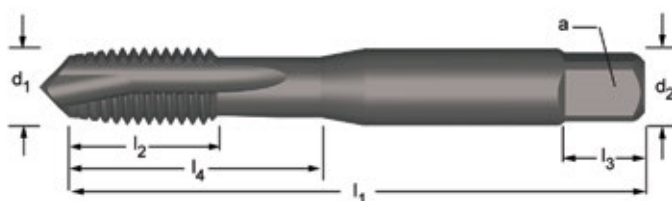

E021



No.2 - 1"

UNC	TPI	d ₁ nom mm	l ₁ mm	l ₂ mm	d ₂ ∅ mm	□ a mm	l ₃ mm	z		l ₄ mm	E021
2	56	2.184	44.5	9.5	2.80	2.24	5	2	1.85	9.5	E0212-56
4	40	2.845	48	14	3.15	2.50	5	3	2.35	14	E0214-40
5	40	3.175	48	12.5	3.15	2.50	5	3	2.65	12.5	E0215-40
6	32	3.505	50	16	3.55	2.80	5	3	2.85	16	E0216-32
8	32	4.166	53	9.5	4.50	3.55	6	3	3.50	17	E0218-32
10	24	4.826	58	11	5.00	4.00	7	3	3.90	20	E02110-24
12	24	5.486	62	12	5.60	4.50	7	3	4.50	21	E02112-24
1/4	20	6.350	66	13	6.30	5.00	8	3	5.10	26	E0211/4
5/16	18	7.938	72	16	8.00	6.30	9	3	6.60	29	E0215/16
3/8	16	9.525	80	18	10.00	8.00	11	3	8.00	32	E0213/8
7/16	14	11.112	85	19	8.00	6.30	9	3	9.40	-	E0217/16
1/2	13	12.700	89	22	9.00	7.10	10	3	10.80	-	E0211/2
5/8	11	15.875	102	24	12.50	10.00	13	3	13.50	-	E0215/8
3/4	10	19.050	112	29	14.00	11.20	14	4	16.50	-	E0213/4
7/8	9	22.225	118	29	16.00	12.50	16	4	19.50	-	E0217/8
1"	8	25.400	130	35	18.00	14.00	18	4	22.25	-	E0211



- EX20**
- UNC 机用丝锥 螺旋槽 45°
 - UNC Macho Máquina Canal Helicoidal 45°
- EX21**
- UNC Machos de máquina Estrías helicoidales a 45°
 - UNC Machine Tap Spiral Flute 45°

EX20	▪	1.1	1.2	1.3	1.4	1.5	7.1	7.2	7.3	7.4
	•	4.1	4.2	5.1	5.2					
EX21	▪	1.1	1.2	1.3	1.4	1.5	2.1	2.2		
	•	2.3								



UNC	TPI	d ₁ nom mm	l ₁ mm	l ₂ mm	d ₂ Ø mm	□ a mm	l ₃ mm	z	↔	l ₄ mm	EX20	EX21
4	40	2.845	56	6	3.5	2.7	6	3	2.35	18	EX204-40	EX214-40
5	40	3.175	56	6	3.5	2.7	6	3	2.65	18	EX205-40	EX215-40
6	32	3.505	56	7	4.0	3.0	6	3	2.85	20	EX206-32	EX216-32
8	32	4.166	63	7	4.5	3.4	8	3	3.5	21	EX208-32	EX218-32
10	24	4.826	70	8	6.0	4.9	8	3	3.9	25	EX210-24	EX2110-24
12	24	5.486	80	10	6.0	4.9	8	3	4.5	30	EX212-24	EX2112-24
1/4	20	6.350	80	10	7.0	5.5	8	3	5.1	30	EX201/4	EX211/4
5/16	18	7.938	90	12	8.0	6.2	9	3	6.6	35	EX205/16	EX215/16
3/8	16	9.525	100	15	10.0	8.0	11	3	8.0	39	EX203/8	EX213/8
7/16	14	11.112	100	15	8.0	6.2	9	3	9.4	-	EX207/16	EX217/16
1/2	13	12.700	110	18	9.0	7.0	10	3	10.8	-	EX201/2	EX211/2
5/8	11	15.875	110	20	12.0	9.0	12	4	13.5	-	EX205/8	EX215/8
3/4	10	19.050	125	25	14.0	11.0	14	4	16.5	-	EX203/4	EX213/4
7/8	9	22.225	140	25	18.0	14.5	17	4	19.5	-	EX207/8	EX217/8
1"	8	25.400	160	30	18.0	14.5	17	4	22.25	-	EX201	EX211

E023

UNC

ISO
529

2B



2.5XD

HSS-E

C
2-3



- UNC 机用丝锥 螺旋槽 45°
- UNC Macho Máquina Canal Helicoidal 45°
- UNC Machos de máquina Estrías helicoidales a 45°
- UNC Machine Tap Spiral Flute 45°

E023

E023 ■ 1.1 1.2 1.3 1.4 1.5

• 2.1 2.2 2.3

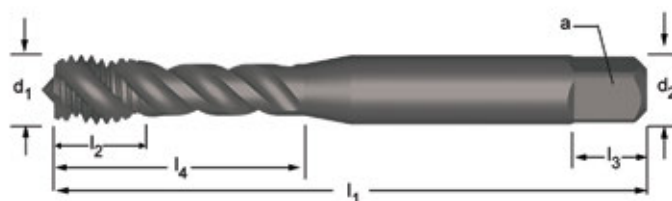

E023



No.2 - 1"

UNC	TPI	d ₁ nom mm	l ₁ mm	l ₂ mm	d ₂ Ø mm	□ a mm	l ₃ mm	z		l ₄ mm	E023
2	56	2.184	44.5	9.5	2.80	2.24	5	2	1.85	9.5	E0232-56
4	40	2.845	48	6	3.15	2.50	5	3	2.35	14	E0234-40
5	40	3.175	48	6	3.15	2.50	5	3	2.65	12.5	E0235-40
6	32	3.505	50	6	3.55	2.80	5	3	2.85	16	E0236-32
8	32	4.166	53	7	4.50	3.55	6	3	3.50	17	E0238-32
10	24	4.826	58	8	5.00	4.00	7	3	3.90	20	E02310-24
12	24	5.486	62	12	5.60	4.50	7	3	4.50	21	E02312-24
1/4	20	6.350	66	10	6.30	5.00	8	3	5.10	28	E0231/4
5/16	18	7.938	72	12	8.00	6.30	9	3	6.60	31	E0235/16
3/8	16	9.525	80	15	10.00	8.00	11	3	8.00	34	E0233/8
7/16	14	11.112	85	19	8.00	6.30	9	3	9.40	-	E0237/16
1/2	13	12.700	89	19	9.00	7.10	10	3	10.80	-	E0231/2
5/8	11	15.875	102	24	12.50	10.00	13	4	13.50	-	E0235/8
3/4	10	19.050	112	29	14.00	11.20	14	4	16.50	-	E0233/4
7/8	9	22.225	118	29	16.00	12.50	16	4	19.50	-	E0237/8
1"	8	25.400	130	35	18.00	14.00	18	4	22.25	-	E0231

E651

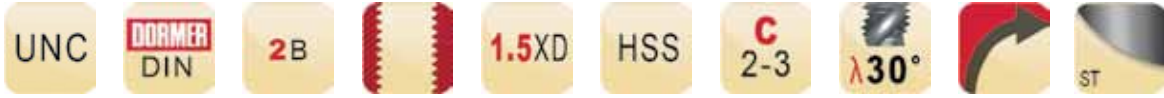

- UNC 钻攻复合刀具 螺旋槽 30°
- UNC Broca-Macho Canal Helicoidal 30°
- UNC Combinación broca-macho Estrías helicoidales a 30°
- UNC Combi Taps Spiral Flute 30°

E651

E651 • 1.1 1.2 1.3 1.4 3.2 6.2 6.3 7.1 7.2 8.1

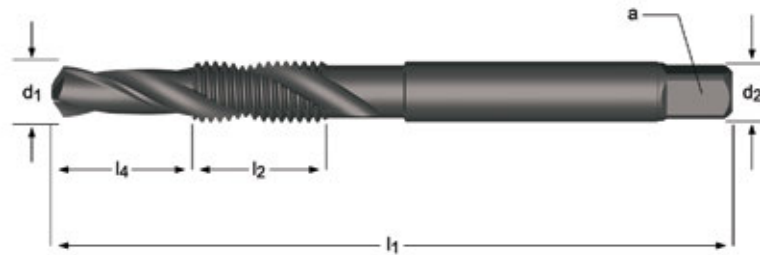

UNC	TPI	d ₁ nom mm	l ₁ mm	l ₂ mm	l ₄ mm	d ₂ ∅ mm	∠ a mm	z	E651
6	32	2.85	56.9	12	6.0	3.50	2.90	2	E6516-32
8	32	3.50	64.0	12	8.0	4.50	3.55	2	E6518-32
10	24	3.90	72.0	15	10.0	5.00	4.00	2	E65110-24
12	24	4.50	77.0	15	11.0	5.60	4.50	2	E65112-24
1/4	20	5.10	83.0	17	13.0	6.30	5.00	2	E6511/4
5/16	18	6.60	94.0	21	16.0	8.00	6.30	2	E6515/16
3/8	16	8.00	107.0	23	19.0	10.00	8.00	2	E6513/8
7/16	14	9.40	107.0	25	22.0	8.00	6.30	2	E6517/16
1/2	13	10.80	114.0	29	25.0	9.00	7.10	2	E6511/2
9/16	12	12.20	124.0	29	28.0	11.20	9.00	2	E6519/16
5/8	11	13.50	134.0	31	32.5	12.50	10.00	2	E6515/8

E111

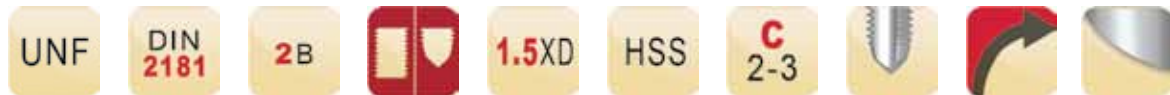

- UNF 手用丝锥 直槽
- UNF Macho Manual Canal Reto
- UNF Machos de mano Estrías rectas
- UNF Hand Tap Straight Flute

E111

E111	1.1	1.2	1.3	1.4	1.5	3.1	3.2	3.3	3.4	6.1	6.2	6.3	6.4	7.2	7.3	7.4	8.2	8.3
------	-----	-----	-----	-----	-----	-----	-----	-----	-----	-----	-----	-----	-----	-----	-----	-----	-----	-----

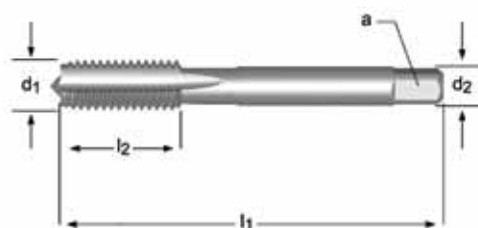

UNF	TPI	d ₁ nom mm	l ₁ mm	l ₂ mm	d ₂ ∅ mm	□ a mm	z		E111
5	44	3.18	45	13	4.0	3.0	3	2.7	E1115-44NO3
5	44	3.18	45	13	4.0	3.0	3	2.7	E1115-44NO9
6	40	3.51	45	10	4.0	3.0	3	2.95	E1116-40NO3
6	40	3.51	45	10	4.0	3.0	3	2.95	E1116-40NO9
8	36	4.17	50	14	6.0	4.9	3	3.5	E1118-36NO3
8	36	4.17	50	14	6.0	4.9	3	3.5	E1118-36NO9
10	32	4.82	50	14	6.0	4.9	3	4.1	E11110-32NO3
10	32	4.82	50	14	6.0	4.9	3	4.1	E11110-32NO9
1/4	28	6.35	56	17	6.0	4.9	3	5.5	E1111/4NO3
1/4	28	6.35	56	17	6.0	4.9	3	5.5	E1111/4NO9
5/16	24	7.94	63	19	6.0	4.9	3	6.9	E1115/16NO3
5/16	24	7.94	63	19	6.0	4.9	3	6.9	E1115/16NO9
3/8	24	9.53	63	16	7.0	5.5	3	8.5	E1113/8NO3
3/8	24	9.53	63	16	7.0	5.5	3	8.5	E1113/8NO9
7/16	20	11.11	63	15	8.0	6.2	3	9.9	E1117/16NO3
7/16	20	11.11	63	15	8.0	6.2	3	9.9	E1117/16NO9
1/2	20	12.70	70	22	9.0	7.0	3	11.5	E1111/2NO3
1/2	20	12.70	70	22	9.0	7.0	3	11.5	E1111/2NO9
9/16	18	14.29	70	16	11.0	9.0	4	12.9	E1119/16NO3
9/16	18	14.29	70	16	11.0	9.0	4	12.9	E1119/16NO9
5/8	18	15.88	70	16	12.0	9.0	4	14.5	E1115/8NO3
5/8	18	15.88	70	16	12.0	9.0	4	14.5	E1115/8NO9
3/4	16	19.05	80	22	14.0	11.0	4	17.5	E1113/4NO3
3/4	16	19.05	80	22	14.0	11.0	4	17.5	E1113/4NO9
7/8	14	22.23	90	22	18.0	14.5	4	20.4	E1117/8NO3
7/8	14	22.23	90	22	18.0	14.5	4	20.4	E1117/8NO9
1"	12	25.40	90	22	20.0	16.0	4	23.25	E1111NO3
1"	12	25.40	90	22	20.0	16.0	4	23.25	E1111NO9





- E229**
- UNF 机用丝锥 直槽
 - UNF Macho Máquina Canal Reto
- E278**
- UNF Machos de máquina Estrías rectas
 - UNF Machine Tap Straight Flute

E229; E278 • 1.1 1.2 1.3 1.4 1.5 3.1 3.2 3.3 6.2 6.3 7.2 7.3 8.2



UNF	TPI	d ₁ nom mm	l ₁ mm	l ₂ mm	d ₂ Ø mm	□ a mm	l ₃ mm	z	↔	l ₄ mm	E229	E278
2	64	2.184	45	7	2.8	2.1	5	3	1.9	12	E2292-64	
3	56	2.515	50	8	2.8	2.1	5	3	2.15	12.5	E2293-56	
4	48	2.845	56	9	3.5	2.7	6	3	2.4	18	E2294-48	
5	44	3.175	56	10	3.5	2.7	6	3	2.7	18	E2295-44	
6	40	3.505	56	11	4.0	3.0	6	3	2.95	20	E2296-40	
8	36	4.166	63	12	4.5	3.4	6	3	3.5	21	E2298-36	
10	32	4.826	70	13	6.0	4.9	8	3	4.1	25	E22910-32	
12	28	5.486	80	15	6.0	4.9	8	3	4.7	30	E22912-28	
1/4	28	6.350	80	15	7.0	5.5	8	3	5.5	30	E2291/4	
5/16	24	7.94	90	18	6.0	4.9	8	3	6.9	-		E2785/16
3/8	24	9.53	100	24	7.0	5.5	8	3	8.5	-		E2783/8
7/16	20	11.11	100	22	9.0	7.0	10	3	9.9	-		E2787/16
1/2	20	12.70	100	21	9.0	7.0	10	3	11.5	-		E2781/2
9/16	18	14.29	100	21	11.0	9.0	12	4	12.9	-		E2789/16
5/8	18	15.88	100	21	12.0	9.0	12	4	14.5	-		E2785/8
3/4	16	19.05	125	25	14.0	11.0	14	4	17.5	-		E2783/4
7/8	14	22.23	140	28	18.0	14.5	17	4	20.4	-		E2787/8
1"	12	25.40	140	26	18.0	14.5	17	4	23.25	-		E2781
1.1/8	12	28.58	150	28	22.0	18.0	21	4	26.5	-		E2781.1/8
1.1/4	12	31.75	150	28	25.0	20.0	23	4	29.5	-		E2781.1/4
1.3/8	12	34.93	170	30	28.0	22.0	25	4	32.75	-		E2781.3/8
1.1/2	12	38.10	170	30	32.0	24.0	27	4	36.0	-		E2781.1/2

E524

UNF

ISO
529

2B



1.5XD

HSS



L120
309

- UNF 机用丝锥 直槽
- UNF Macho Máquina Canal Reto
- UNF Machos de máquina Estrías rectas
- UNF Machine Tap Straight Flute

E524

E524 • 1.1 1.2 1.3 1.4 1.5 3.1 3.2 3.3 3.4 6.1 6.2 6.3 6.4 7.2 7.3 7.4 8.2 8.3

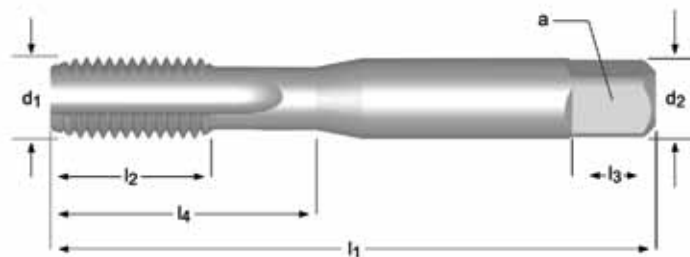

E524



No.0 - 1.1/2

UNF	TPI	d ₁ nom mm	l ₁ mm	l ₂ mm	d ₂ Ø mm	∠ a mm	l ₃ mm	z		l ₄ mm	E524
0	80	1.524	41	7	2.50	2.00	4	2	1.25	7	E5240-80NO1
0	80	1.524	41	7	2.50	2.00	4	2	1.25	7	E5240-80NO2
0	80	1.524	41	7	2.50	2.00	4	2	1.25	7	E5240-80NO3
1	72	1.854	41	8	2.50	2.00	4	2	1.55	8	E5241-72NO1
1	72	1.854	41	8	2.50	2.00	4	2	1.55	8	E5241-72NO2
1	72	1.854	41	8	2.50	2.00	4	2	1.55	8	E5241-72NO3
2	64	2.184	44.5	9.5	2.80	2.24	5	3	1.9	9.5	E5242-64NO1
2	64	2.184	44.5	9.5	2.80	2.24	5	3	1.9	9.5	E5242-64NO2
2	64	2.184	44.5	9.5	2.80	2.24	5	3	1.9	9.5	E5242-64NO3
4	48	2.845	48	12.5	3.15	2.50	5	3	2.4	12.5	E5244-48NO1
4	48	2.845	48	12.5	3.15	2.50	5	3	2.4	12.5	E5244-48NO2
4	48	2.845	48	12.5	3.15	2.50	5	3	2.4	12.5	E5244-48NO3
5	44	3.175	48	12.5	3.15	2.50	5	3	2.7	12.5	E5245-44NO1
5	44	3.175	48	12.5	3.15	2.50	5	3	2.7	12.5	E5245-44NO2
5	44	3.175	48	12.5	3.15	2.50	5	3	2.7	12.5	E5245-44NO3
6	40	3.505	50	14	3.55	2.80	5	3	2.95	14	E5246-40NO1
6	40	3.505	50	14	3.55	2.80	5	3	2.95	14	E5246-40NO2
6	40	3.505	50	14	3.55	2.80	5	3	2.95	14	E5246-40NO3
8	36	4.166	53	9.5	4.50	3.55	6	3	3.5	17	E5248-36NO1
8	36	4.166	53	9.5	4.50	3.55	6	3	3.5	17	E5248-36NO2
8	36	4.166	53	9.5	4.50	3.55	6	3	3.5	17	E5248-36NO3
10	32	4.826	58	11	5.00	4.00	7	3	4.1	20	E52410-32NO1
10	32	4.826	58	11	5.00	4.00	7	3	4.1	20	E52410-32NO2
10	32	4.826	58	11	5.00	4.00	7	3	4.1	20	E52410-32NO3
10	32	4.826	58	11	5.00	4.00	7	3	4.1	20	E52410-32NO6
12	28	5.486	62	12	5.60	4.50	7	3	4.7	21	E52412-28NO1
12	28	5.486	62	12	5.60	4.50	7	3	4.7	21	E52412-28NO2
12	28	5.486	62	12	5.60	4.50	7	3	4.7	21	E52412-28NO3
12	28	5.486	62	12	5.60	4.50	7	3	4.7	21	E52412-28NO6
1/4	28	6.350	66	13	6.30	5.00	8	3	5.5	26	E5241/4NO1
1/4	28	6.350	66	13	6.30	5.00	8	3	5.5	26	E5241/4NO2
1/4	28	6.350	66	13	6.30	5.00	8	3	5.5	26	E5241/4NO3
1/4	28	6.350	66	13	6.30	5.00	8	3	5.5	26	E5241/4NO6
5/16	24	7.938	72	16	8.00	6.30	9	3	6.9	29	E5245/16NO1
5/16	24	7.938	72	16	8.00	6.30	9	3	6.9	29	E5245/16NO2
5/16	24	7.938	72	16	8.00	6.30	9	3	6.9	29	E5245/16NO3
5/16	24	7.938	72	16	8.00	6.30	9	3	6.9	29	E5245/16NO6
3/8	24	9.525	80	18	10.00	8.00	11	3	8.5	32	E5243/8NO1
3/8	24	9.525	80	18	10.00	8.00	11	3	8.5	32	E5243/8NO2
3/8	24	9.525	80	18	10.00	8.00	11	3	8.5	32	E5243/8NO3

NO1
NO9
198

UNF	TPI	d ₁ nom mm	l ₁ mm	l ₂ mm	d ₂ ∅ mm	□ a mm	l ₃ mm	z		l ₄ mm	E524
3/8	24	9.525	80	18	10.00	8.00	11	3	8.5	32	E5243/8NO6
7/16	20	11.112	85	19	8.00	6.30	9	3	9.9	-	E5247/16NO1
7/16	20	11.112	85	19	8.00	6.30	9	3	9.9	-	E5247/16NO2
7/16	20	11.112	85	19	8.00	6.30	9	3	9.9	-	E5247/16NO3
7/16	20	11.112	85	19	8.00	6.30	9	3	9.9	-	E5247/16NO6
1/2	20	12.700	89	22	9.00	7.10	10	3	11.5	-	E5241/2NO1
1/2	20	12.700	89	22	9.00	7.10	10	3	11.5	-	E5241/2NO2
1/2	20	12.700	89	22	9.00	7.10	10	3	11.5	-	E5241/2NO3
1/2	20	12.700	89	22	9.00	7.10	10	3	11.5	-	E5241/2NO6
9/16	18	14.288	95	24	11.20	9.00	12	4	12.9	-	E5249/16NO1
9/16	18	14.288	95	24	11.20	9.00	12	4	12.9	-	E5249/16NO2
9/16	18	14.288	95	24	11.20	9.00	12	4	12.9	-	E5249/16NO3
9/16	18	14.288	95	24	11.20	9.00	12	4	12.9	-	E5249/16NO6
5/8	18	15.875	102	24	12.50	10.00	13	4	14.5	-	E5245/8NO1
5/8	18	15.875	102	24	12.50	10.00	13	4	14.5	-	E5245/8NO2
5/8	18	15.875	102	24	12.50	10.00	13	4	14.5	-	E5245/8NO3
5/8	18	15.875	102	24	12.50	10.00	13	4	14.5	-	E5245/8NO6
3/4	16	19.050	112	29	14.00	11.20	14	4	17.5	-	E5243/4NO1
3/4	16	19.050	112	29	14.00	11.20	14	4	17.5	-	E5243/4NO2
3/4	16	19.050	112	29	14.00	11.20	14	4	17.5	-	E5243/4NO3
3/4	16	19.050	112	29	14.00	11.20	14	4	17.5	-	E5243/4NO6
7/8	14	22.225	118	29	16.00	12.50	16	4	20.4	-	E5247/8NO1
7/8	14	22.225	118	29	16.00	12.50	16	4	20.4	-	E5247/8NO2
7/8	14	22.225	118	29	16.00	12.50	16	4	20.4	-	E5247/8NO3
7/8	14	22.225	118	29	16.00	12.50	16	4	20.4	-	E5247/8NO6
1"	12	25.400	130	35	18.00	14.00	18	4	23.25	-	E5241NO1
1"	12	25.400	130	35	18.00	14.00	18	4	23.25	-	E5241NO2
1"	12	25.400	130	35	18.00	14.00	18	4	23.25	-	E5241NO3
1"	12	25.400	130	35	18.00	14.00	18	4	23.25	-	E5241NO6
1.1/8	12	28.575	138	35	20.00	16.00	20	4	26.5	-	E5241.1/8NO1
1.1/8	12	28.575	138	35	20.00	16.00	20	4	26.5	-	E5241.1/8NO2
1.1/8	12	28.575	138	35	20.00	16.00	20	4	26.5	-	E5241.1/8NO3
1.1/4	12	31.750	151	41	22.40	18.00	22	4	29.5	-	E5241.1/4NO1
1.1/4	12	31.750	151	41	22.40	18.00	22	4	29.5	-	E5241.1/4NO2
1.1/4	12	31.750	151	41	22.40	18.00	22	4	29.5	-	E5241.1/4NO3
1.3/8	12	34.925	162	47	25.00	20.00	24	4	32.75	-	E5241.3/8NO1
1.3/8	12	34.925	162	47	25.00	20.00	24	4	32.75	-	E5241.3/8NO2
1.3/8	12	34.925	162	47	25.00	20.00	24	4	32.75	-	E5241.3/8NO3
1.1/2	12	38.100	170	47	28.00	22.40	26	4	36	-	E5241.1/2NO1
1.1/2	12	38.100	170	47	28.00	22.40	26	4	36	-	E5241.1/2NO2
1.1/2	12	38.100	170	47	28.00	22.40	26	4	36	-	E5241.1/2NO3





- EP30**
- UNF 机用丝锥 螺尖
 - UNF Macho Máquina Ponta Helicoidal
- EP31**
- UNF Machos de máquina Entrada en hélice
 - UNF Machine Tap Spiral Point

EP30	▪	1.1	1.2	1.3	1.4	1.5	6.1	6.3	7.1	7.2	7.3	7.4
	•	1.6	3.1	3.2	3.3	3.4	4.1	4.2	5.1	5.2	6.2	8.1
EP31	▪	1.1	1.2	1.3	1.4	1.5						
	•	1.6	2.1	2.2	2.3	3.1	3.2	3.3	3.4			

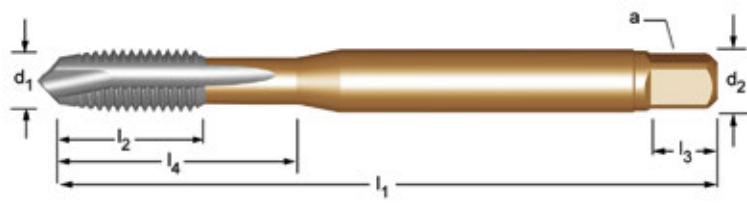

UNF	TPI	d ₁ nom mm	l ₁ mm	l ₂ mm	d ₂ Ø mm	□ a mm	l ₃ mm	z	↔	l ₄ mm	EP30	EP31
8	36	4.166	63	12	4.5	3.4	8	3	3.5	21	EP308-36	EP318-36
10	32	4.826	70	13	6.0	4.9	8	3	4.1	25	EP3010-32	EP3110-32
1/4	28	6.350	80	15	7.0	5.5	8	3	5.5	30	EP301/4	EP311/4
5/16	24	7.938	90	18	8.0	6.2	9	3	6.9	35	EP305/16	EP315/16
3/8	24	9.525	100	20	10.0	8.0	11	3	8.5	39	EP303/8	EP313/8
7/16	20	11.112	100	20	8.0	6.2	9	3	9.9	-	EP307/16	EP317/16
1/2	20	12.700	110	23	9.0	7.0	10	3	11.5	-	EP301/2	EP311/2
5/8	18	15.875	110	25	12.0	9.0	12	3	14.5	-	EP305/8	EP315/8
3/4	16	19.050	125	30	14.0	11.0	14	4	17.5	-	EP303/4	EP313/4
7/8	14	22.225	140	34	18.0	14.5	17	4	20.4	-	EP307/8	EP317/8
1"	12	25.400	160	38	18.0	14.5	17	4	23.25	-	EP301	EP311

E031

UNF

ISO
529

2B



2.5XD

HSS-E

B
3.5-5



- UNF 机用丝锥 螺尖
- UNF Macho Máquina Ponta Helicoidal
- UNF Machos de máquina Entrada en hélice
- UNF Machine Tap Spiral Point

E031

E031	▪	1.1	1.2	1.3	1.4	1.5					
	•	1.6	2.1	2.2	2.3	3.1	3.2	3.3	3.4		

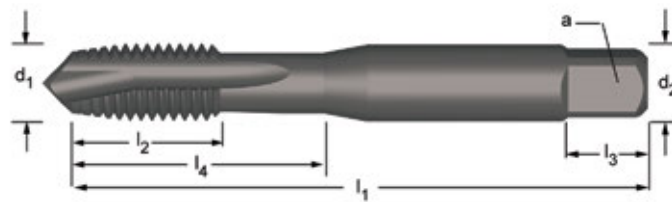

E031



No.8 - 1"

UNF	TPI	d ₁ nom mm	l ₁ mm	l ₂ mm	d ₂ ∅ mm	∠ a mm	l ₃ mm	z		l ₄ mm	E031
8	36	4.166	53	9.5	4.5	3.55	6	3	3.50	17	E0318-36
10	32	4.826	58	11	5.0	4.00	7	3	4.10	20	E03110-32
1/4	28	6.350	66	13	6.3	5.00	8	3	5.50	26	E0311/4
5/16	24	7.938	72	16	8.0	6.30	9	3	6.90	29	E0315/16
3/8	24	9.525	80	18	10.0	8.00	11	3	8.50	32	E0313/8
7/16	20	11.112	85	19	8.0	6.30	9	3	9.90	-	E0317/16
1/2	20	12.700	89	22	9.0	7.10	10	3	11.50	-	E0311/2
9/16	18	14.288	95	24	11.2	9.00	12	3	12.90	-	E0319/16
5/8	18	15.875	102	24	12.5	10.00	13	3	14.50	-	E0315/8
3/4	16	19.050	112	29	14.0	11.20	14	4	17.50	-	E0313/4
7/8	14	22.225	118	29	16.0	12.50	16	4	20.40	-	E0317/8
1"	12	25.400	130	35	18.0	14.00	18	4	23.25	-	E0311



- EX30**
- UNF 机用丝锥 螺旋槽 45°
 - UNF Macho Máquina Canal Helicoidal 45°
- EX31**
- UNF Machos de máquina Estrías helicoidales a 45°
 - UNF Machine Tap Spiral Flute 45°

EX30	▪	1.1	1.2	1.3	1.4	1.5	7.1	7.2	7.3	7.4
	•	4.1	4.2	5.1	5.2					
EX31	▪	1.1	1.2	1.3	1.4	1.5	2.1	2.2		
	•	2.3								

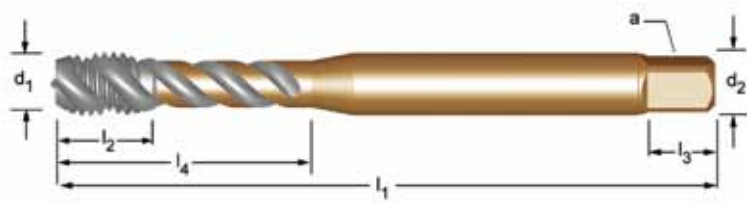

UNF	TPI	d ₁ nom mm	l ₁ mm	l ₂ mm	d ₂ Ø mm	□ a mm	l ₃ mm	z	↔	l ₄ mm	EX30	EX31
8	36	4.166	63	7	4.5	3.4	8	3	3.5	21	EX308-36	EX318-36
10	32	4.826	70	8	6.0	4.9	8	3	4.1	25	EX3010-32	EX3110-32
1/4	28	6.350	80	10	7.0	5.5	8	3	5.5	30	EX301/4	EX311/4
5/16	24	7.938	90	12	8.0	6.2	9	3	6.9	35	EX305/16	EX315/16
3/8	24	9.525	100	15	10.0	8.0	11	3	8.5	39	EX303/8	EX313/8
7/16	20	11.112	100	15	8.0	6.2	9	3	9.9	-	EX307/16	EX317/16
1/2	20	12.700	110	18	9.0	7.0	10	3	11.5	-	EX301/2	EX311/2
5/8	18	15.875	110	20	12.0	9.0	12	4	14.5	-	EX305/8	EX315/8
3/4	16	19.050	125	25	14.0	11.0	14	4	17.5	-	EX303/4	EX313/4
7/8	14	22.225	140	25	18.0	14.5	17	4	20.4	-	EX307/8	EX317/8
1"	12	25.400	160	30	18.0	14.5	17	4	23.25	-	EX301	EX311

E033



- UNF 机用丝锥 螺旋槽 45°
- UNF Macho Máquina Canal Helicoidal 45°
- UNF Machos de máquina Estrías helicoidales a 45°
- UNF Machine Tap Spiral Flute 45°

E033

E033	■	1.1	1.2	1.3	1.4	1.5
	•	1.6	2.1	2.2	2.3	

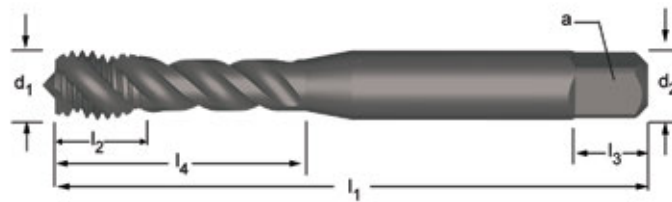

UNF	TPI	d ₁ nom mm	l ₁ mm	l ₂ mm	d ₂ Ø mm	□ a mm	l ₃ mm	z		l ₄ mm	E033
8	36	4.166	53	7	4.5	3.55	6	3	3.50	17	E0338-36
10	32	4.826	58	8	5.0	4.00	7	3	4.10	20	E03310-32
1/4	28	6.350	66	10	6.3	5.00	8	3	5.50	28	E0331/4
5/16	24	7.938	72	12	8.0	6.30	9	3	6.90	31	E0335/16
3/8	24	9.525	80	15	10.0	8.00	11	3	8.50	34	E0333/8
7/16	20	11.112	85	19	8.0	6.30	9	3	9.90	-	E0337/16
1/2	20	12.700	89	22	9.0	7.10	10	3	11.50	-	E0331/2
9/16	18	14.288	95	24	11.2	9.00	12	3	12.90	-	E0339/16
5/8	18	15.875	102	24	12.5	10.00	13	4	14.50	-	E0335/8
3/4	16	19.050	112	29	14.0	11.20	14	4	17.50	-	E0333/4
7/8	14	22.225	118	29	16.0	12.50	16	4	20.40	-	E0337/8
1"	12	25.400	130	35	18.0	14.00	18	4	23.25	-	E0331

E654

UNF



Medium



1.5XD

HSS



- UNF 钻攻复合刀具 螺旋槽 30°
- UNF Broca-Macho Canal Helicoidal 30°
- UNF Combinación broca-macho Estrías helicoidales a 30°
- UNF Combi Taps Spiral Flute 30°

E654

E654 • 1.1 1.2 1.3 1.4 3.2 6.2 6.3 7.1 7.2 8.1

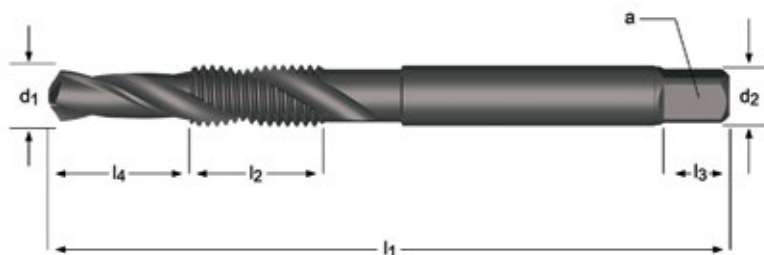

UNF	TPI	d ₁ nom mm	l ₁ mm	l ₂ mm	l ₄ mm	d ₂ Ø mm	∠ a mm	E654
8	36	3.50	64	13	8	4.5	3.55	E6548-36
10	32	4.10	72	16	10	5.0	4.00	E65410-32
12	28	4.70	77	17	11	5.6	4.50	E65412-28
1/4	28	5.50	83	19	13	6.3	5.00	E6541/4
5/16	24	6.90	94	22	16	8.0	6.30	E6545/16
3/8	24	8.50	104	24	19	10.0	8.00	E6543/8
7/16	20	9.90	107	25	22	8.0	6.30	E6547/16
1/2	20	11.50	114	29	25	9.0	7.10	E6541/2
5/8	18	14.50	134	32	32	12.5	10.00	E6545/8

E570

UN

ISO
529

2B



1.5XD

HSS

C
2-3



- UN 机用丝锥 直槽
- UN Macho Máquina Canal Reto
- UN Machos de máquina Estrías rectas
- UN Machine Tap Straight Flute

E570

E570 • 1.1 1.2 1.3 1.4 1.5 3.1 3.2 3.3 3.4 6.1 6.2 6.3 6.4 7.2 7.3 7.4 8.2 8.3

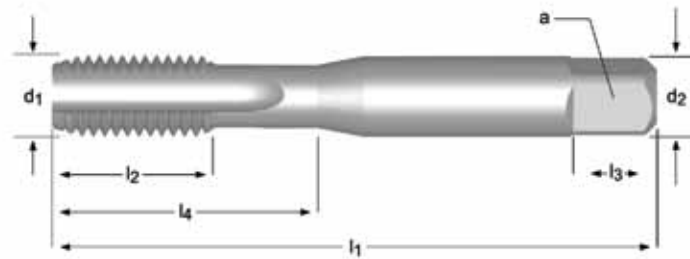

E570



1/4 - 1.5/16

UN	TPI	d ₁ nom mm	l ₁ mm	l ₂ mm	d ₂ Ø mm	∠ a mm	z		l ₄ mm	E570
1/4	32	6.350	66	13	6.3	5.00	3	5.6	26	E5701/4X32NO3
1/4	36	6.350	66	13	6.3	5.00	3	5.7	26	E5701/4X36NO3
1/4	40	6.350	66	13	6.3	5.00	3	5.7	26	E5701/4X40NO3
5/16	32	7.938	72	16	8.0	6.30	3	7.2	29	E5705/16X32NO3
3/8	32	9.525	80	18	10.0	8.00	3	8.8	32	E5703/8X32NO3
7/16	24	11.112	85	19	8.0	6.30	3	10	-	E5707/16X24NO3
7/16	28	11.112	85	19	8.0	6.30	3	10.2	-	E5707/16X28NO3
1/2	28	12.700	89	22	9.0	7.10	3	11.8	-	E5701/2X28NO3
9/16	24	14.288	95	24	11.2	9.00	4	13.25	-	E5709/16X24NO3
5/8	24	15.875	102	24	12.5	10.00	4	14.8	-	E5705/8X24NO3
3/4	20	19.050	112	29	14.0	11.20	4	17.8	-	E5703/4X20NO3
7/8	20	22.225	118	30	16.0	12.50	4	21	-	E5707/8X20NO3
1"	14	25.400	130	36	18.0	14.00	4	23.5	-	E5701X14NO3
1.1/16	12	26.988	127	37	20.0	16.00	4	24.75	-	E5701.1/16X12NO3
1.1/8	8	28.575	138	35	20.0	16.00	4	25.5	-	E5701.1/8X8NO3
1.3/16	12	30.163	137	37	22.4	18.00	4	28	-	E5701.3/16X12NO3
1.1/4	8	31.750	151	41	22.4	18.00	4	28.5	-	E5701.1/4X8NO3
1.5/16	12	33.338	137	37	22.4	18.00	4	31.25	-	E5701.5/16X12NO3

NO1
NO9
198

E115

BSW

DIN
351

Medium



1.5XD

HSS

C
2-3



- BSW 手用丝锥 直槽
- BSW Macho Manual Canal Reto
- BSW Machos de mano Estrías rectas
- BSW Hand Tap Straight Flute

E115

E115 • 1.1 1.2 1.3 1.4 1.5 3.1 3.2 3.3 3.4 6.1 6.2 6.3 6.4 7.2 7.3 7.4 8.2 8.3

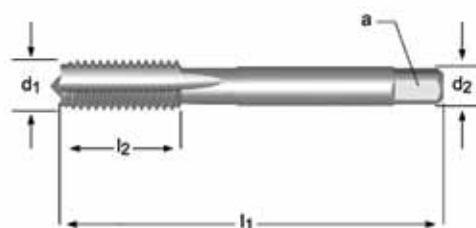

E115



1/8 - 1"

BSW	TPI	d ₁ nom mm	l ₁ mm	l ₂ mm	d ₂ ∅ mm	∠ a mm	z		E115
1/8	40	3.175	40	10	3.5	2.7	3	2.55	E1151/8NO3
1/8	40	3.175	40	10	3.5	2.7	3	2.55	E1151/8NO8
5/32	32	3.969	45	12	4.5	3.4	3	3.2	E1155/32NO3
5/32	32	3.969	45	12	4.5	3.4	3	3.2	E1155/32NO8
3/16	24	4.763	50	16	5.5	4.3	3	3.7	E1153/16NO3
3/16	24	4.763	50	16	5.5	4.3	3	3.7	E1153/16NO8
1/4	20	6.350	56	17	6.0	4.9	3	5.1	E1151/4NO3
1/4	20	6.350	56	17	6.0	4.9	3	5.1	E1151/4NO8
5/16	18	7.938	63	25	6.0	4.9	3	6.5	E1155/16NO3
5/16	18	7.938	63	25	6.0	4.9	3	6.5	E1155/16NO8
3/8	16	9.525	70	22	7.0	5.5	3	7.9	E1153/8NO3
3/8	16	9.525	70	22	7.0	5.5	3	7.9	E1153/8NO8
7/16	14	11.113	75	30	8.0	6.2	3	9.2	E1157/16NO3
7/16	14	11.113	75	30	8.0	6.2	3	9.2	E1157/16NO8
1/2	12	12.700	80	30	9.0	7.0	3	10.5	E1151/2NO3
1/2	12	12.700	80	30	9.0	7.0	3	10.5	E1151/2NO8
9/16	12	14.288	80	30	11.0	9.0	4	12	E1159/16NO3
9/16	12	14.288	80	30	11.0	9.0	4	12	E1159/16NO8
5/8	11	15.875	90	36	12.0	9.0	4	13.5	E1155/8NO3
5/8	11	15.875	90	36	12.0	9.0	4	13.5	E1155/8NO8
3/4	10	19.050	105	40	14.0	11.0	4	16.5	E1153/4NO3
3/4	10	19.050	105	40	14.0	11.0	4	16.5	E1153/4NO8
7/8	9	22.225	110	45	18.0	14.5	4	19.25	E1157/8NO3
7/8	9	22.225	110	45	18.0	14.5	4	19.25	E1157/8NO8
1"	8	25.400	110	50	20.0	16.0	4	22	E1151NO3
1"	8	25.400	110	50	20.0	16.0	4	22	E1151NO8

NO1
NO9
198

E531

BSW

ISO
529

Medium



1.5XD

HSS



- BSW 机用丝锥 直槽
- BSW Macho Máquina Canal Reto
- BSW Machos de máquina Estrías rectas
- BSW Machine Tap Straight Flute

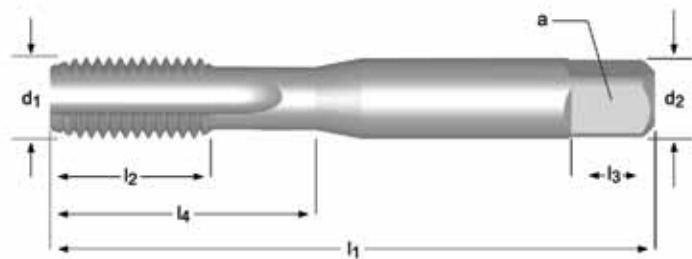

E531

E531	1.1	1.2	1.3	1.4	1.5	3.1	3.2	3.3	3.4	6.1	6.2	6.3	6.4	7.2	7.3	7.4	8.2	8.3
------	-----	-----	-----	-----	-----	-----	-----	-----	-----	-----	-----	-----	-----	-----	-----	-----	-----	-----



BSW	TPI	d ₁ nom mm	l ₁ mm	l ₂ mm	d ₂ Ø mm	□ a mm	z	↔	l ₄ mm	E531
1/8	40	3.175	48	12.5	3.15	2.50	3	2.55	12.5	E5311/8NO1
1/8	40	3.175	48	12.5	3.15	2.50	3	2.55	12.5	E5311/8NO2
1/8	40	3.175	48	12.5	3.15	2.50	3	2.55	12.5	E5311/8NO3
1/8	40	3.175	48	12.5	3.15	2.50	3	2.55	12.5	E5311/8NO6
5/32	32	3.969	53	14	4.00	3.15	3	3.2	14	E5315/32NO1
5/32	32	3.969	53	14	4.00	3.15	3	3.2	14	E5315/32NO2
5/32	32	3.969	53	14	4.00	3.15	3	3.2	14	E5315/32NO3
5/32	32	3.969	53	14	4.00	3.15	3	3.2	14	E5315/32NO6
3/16	24	4.763	58	11	5.00	4.00	3	3.7	20	E5313/16NO1
3/16	24	4.763	58	11	5.00	4.00	3	3.7	20	E5313/16NO2
3/16	24	4.763	58	11	5.00	4.00	3	3.7	20	E5313/16NO3
3/16	24	4.763	58	11	5.00	4.00	3	3.7	20	E5313/16NO6
1/4	20	6.350	66	13	6.30	5.00	3	5.1	26	E5311/4NO1
1/4	20	6.350	66	13	6.30	5.00	3	5.1	26	E5311/4NO2
1/4	20	6.350	66	13	6.30	5.00	3	5.1	26	E5311/4NO3
1/4	20	6.350	66	13	6.30	5.00	3	5.1	26	E5311/4NO6
5/16	18	7.938	72	16	8.00	6.30	3	6.5	29	E5315/16NO1
5/16	18	7.938	72	16	8.00	6.30	3	6.5	29	E5315/16NO2
5/16	18	7.938	72	16	8.00	6.30	3	6.5	29	E5315/16NO3
5/16	18	7.938	72	16	8.00	6.30	3	6.5	29	E5315/16NO6
3/8	16	9.525	80	18	10.00	8.00	3	7.9	32	E5313/8NO1
3/8	16	9.525	80	18	10.00	8.00	3	7.9	32	E5313/8NO2
3/8	16	9.525	80	18	10.00	8.00	3	7.9	32	E5313/8NO3
3/8	16	9.525	80	18	10.00	8.00	3	7.9	32	E5313/8NO6
7/16	14	11.112	85	19	8.00	6.30	3	9.2	-	E5317/16NO1
7/16	14	11.112	85	19	8.00	6.30	3	9.2	-	E5317/16NO2
7/16	14	11.112	85	19	8.00	6.30	3	9.2	-	E5317/16NO3
7/16	14	11.112	85	19	8.00	6.30	3	9.2	-	E5317/16NO6
1/2	12	12.700	89	22	9.00	7.10	3	10.5	-	E5311/2NO1
1/2	12	12.700	89	22	9.00	7.10	3	10.5	-	E5311/2NO2
1/2	12	12.700	89	22	9.00	7.10	3	10.5	-	E5311/2NO3
1/2	12	12.700	89	22	9.00	7.10	3	10.5	-	E5311/2NO6
5/8	11	15.875	102	24	12.50	10.00	4	13.5	-	E5315/8NO1
5/8	11	15.875	102	24	12.50	10.00	4	13.5	-	E5315/8NO2
5/8	11	15.875	102	24	12.50	10.00	4	13.5	-	E5315/8NO3
5/8	11	15.875	102	24	12.50	10.00	4	13.5	-	E5315/8NO6
3/4	10	19.050	112	29	14.00	11.20	4	16.5	-	E5313/4NO1
3/4	10	19.050	112	29	14.00	11.20	4	16.5	-	E5313/4NO2

NO1
NO9
198

BSW	TPI	d ₁ nom mm	l ₁ mm	l ₂ mm	d ₂ Ø mm	 a mm	z	 ↔	l ₄ mm	E531
3/4	10	19.050	112	29	14.00	11.20	4	16.5	-	E5313/4NO3
3/4	10	19.050	112	29	14.00	11.20	4	16.5	-	E5313/4NO6
1"	8	25.400	130	35	18.00	14.00	4	22	-	E5311NO1
1"	8	25.400	130	35	18.00	14.00	4	22	-	E5311NO2
1"	8	25.400	130	35	18.00	14.00	4	22	-	E5311NO3
1"	8	25.400	130	35	18.00	14.00	4	22	-	E5311NO6



E534

BSW

ISO
529

Medium



2.5XD

HSS

B
3.5-5



- BSW 机用丝锥 螺尖
- BSW Macho Máquina Ponta Helicoidal
- BSW Machos de máquina Entrada en hélice
- BSW Machine Tap Spiral Point

E534

E534	▪	1.1	1.2	1.3	1.4	2.1	2.2	2.3					
	•	1.5	1.6	4.3	5.1	5.2	6.1	6.3	7.1	7.2	7.3	7.4	8.1



BSW	TPI	d ₁ nom mm	l ₁ mm	l ₂ mm	d ₂ ∅ mm	□ a mm	z		l ₄ mm	E534
1/8	40	3.175	48	12.5	3.15	2.50	3	2.55	12.5	E5341/8
5/32	32	3.969	53	14	4.00	3.15	3	3.2	14	E5345/32
3/16	24	4.763	58	11	5.00	4.00	3	3.7	20	E5343/16
1/4	20	6.350	66	13	6.30	5.00	3	5.1	26	E5341/4
5/16	18	7.938	72	16	8.00	6.30	3	6.5	29	E5345/16
3/8	16	9.525	80	18	10.00	8.00	3	7.9	32	E5343/8
7/16	14	11.112	85	19	8.00	6.30	3	9.2	-	E5347/16
1/2	12	12.700	89	22	9.00	7.10	3	10.5	-	E5341/2
5/8	11	15.875	102	24	12.50	10.00	3	13.5	-	E5345/8
3/4	10	19.050	112	29	14.00	11.20	4	16.5	-	E5343/4

E533

BSW

ISO
529

Medium



2XD

HSS

C
2-3



- BSW 机用丝锥 螺旋槽 40°
- BSW Macho Máquina Canal Helicoidal 40°
- BSW Machos de máquina Estrías helicoidales a 40°
- BSW Machine Tap Spiral Flute 40°

E533

E533	■	1.2	1.3	1.4	2.1	2.2	2.3
	•	1.5	5.2	7.1	7.2	7.3	7.4



E533



1/8 - 3/4

BSW	TPI	d ₁ nom mm	l ₁ mm	l ₂ mm	d ₂ Ø mm	□ a mm	z		l ₄ mm	E533
1/8	40	3.175	48	12.5	3.15	2.50	3	2.55	12.5	E5331/8 ²⁾
1/8	40	3.175	48	12.5	3.15	2.50	3	2.55	12.5	E5331/8BLUE
3/16	24	4.763	58	11	5.00	4.00	3	3.7	20	E5333/16 ²⁾
3/16	24	4.763	58	11	5.00	4.00	3	3.7	20	E5333/16BLUE
1/4	20	6.350	66	13	6.30	5.00	3	5.1	26	E5331/4 ²⁾
1/4	20	6.350	66	13	6.30	5.00	3	5.1	26	E5331/4BLUE
5/16	18	7.938	72	16	8.00	6.30	3	6.5	31	E5335/16 ²⁾
5/16	18	7.938	72	16	8.00	6.30	3	6.5	31	E5335/16BLUE
3/8	16	9.525	80	18	10.00	8.00	3	7.9	34	E5333/8 ²⁾
3/8	16	9.525	80	18	10.00	8.00	3	7.9	34	E5333/8BLUE
1/2	12	12.700	89	22	9.00	7.10	3	10.5	-	E5331/2 ²⁾
1/2	12	12.700	89	22	9.00	7.10	3	10.5	-	E5331/2BLUE
5/8	11	15.875	102	24	12.50	10.00	3	13.5	-	E5335/8 ²⁾
5/8	11	15.875	102	24	12.50	10.00	3	13.5	-	E5335/8BLUE
3/4	10	19.050	112	29	14.00	11.20	3	16.5	-	E5333/4 ²⁾
3/4	10	19.050	112	29	14.00	11.20	3	16.5	-	E5333/4BLUE

²⁾ 光亮 / Brilhante / Brillante / Bright Finish

E536

BSF

ISO
529

Medium



1.5XD

HSS



- BSF 机用丝锥 直槽
- BSF Macho Máquina Canal Reto
- BSF Machos de máquina Estriás rectas
- BSF Machine Tap Straight Flute

E536

E536

6.1

1.1

1.2

1.3

1.4

1.5

1.6

2.1

2.2

2.3

3.1

3.2

3.3

3.4

6.2

6.3

6.4

7.2

7.3

7.4

8.2

8.3

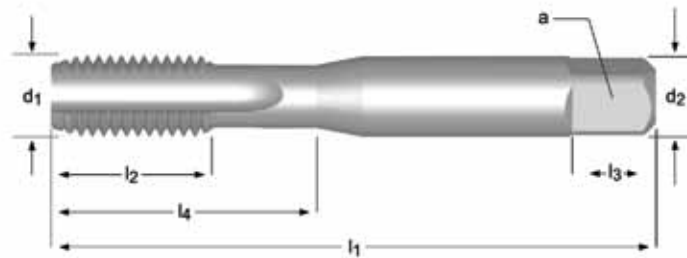

E536



3/16 - 1°

BSF	TPI	d ₁ nom mm	l ₁ mm	l ₂ mm	d ₂ Ø mm	□ a mm	z	↕	l ₄ mm	E536
3/16	32	4.76	58	12	5.0	4.0	3	4	20	E5363/16NO1
3/16	32	4.76	58	12	5.0	4.0	3	4	20	E5363/16NO2
3/16	32	4.76	58	12	5.0	4.0	3	4	20	E5363/16NO3
3/16	32	4.76	58	12	5.0	4.0	3	4	20	E5363/16NO6
1/4	26	6.35	66	14	6.3	5.0	3	5.3	26	E5361/4NO1
1/4	26	6.35	66	14	6.3	5.0	3	5.3	26	E5361/4NO2
1/4	26	6.35	66	14	6.3	5.0	3	5.3	26	E5361/4NO3
1/4	26	6.35	66	14	6.3	5.0	3	5.3	26	E5361/4NO6
5/16	22	7.94	72	18	8.0	6.3	3	6.8	29	E5365/16NO1
5/16	22	7.94	72	18	8.0	6.3	3	6.8	29	E5365/16NO2
5/16	22	7.94	72	18	8.0	6.3	3	6.8	29	E5365/16NO3
5/16	22	7.94	72	18	8.0	6.3	3	6.8	29	E5365/16NO6
3/8	20	9.53	80	20	10.0	8.0	3	8.3	32	E5363/8NO1
3/8	20	9.53	80	20	10.0	8.0	3	8.3	32	E5363/8NO2
3/8	20	9.53	80	20	10.0	8.0	3	8.3	32	E5363/8NO3
3/8	20	9.53	80	20	10.0	8.0	3	8.3	32	E5363/8NO6
7/16	18	11.11	85	20	8.0	6.3	3	9.7	-	E5367/16NO1
7/16	18	11.11	85	20	8.0	6.3	3	9.7	-	E5367/16NO2
7/16	18	11.11	85	20	8.0	6.3	3	9.7	-	E5367/16NO3
1/2	16	12.70	89	23	9.0	7.1	3	11	-	E5361/2NO1
1/2	16	12.70	89	23	9.0	7.1	3	11	-	E5361/2NO2
1/2	16	12.70	89	23	9.0	7.1	3	11	-	E5361/2NO3
1/2	16	12.70	89	23	9.0	7.1	3	11	-	E5361/2NO6
9/16	16	14.28	95	25	11.2	9.0	4	12.7	-	E5369/16NO1
9/16	16	14.28	95	25	11.2	9.0	4	12.7	-	E5369/16NO2
9/16	16	14.28	95	25	11.2	9.0	4	12.7	-	E5369/16NO3
5/8	14	15.88	102	25	12.5	10.0	4	14	-	E5365/8NO1
5/8	14	15.88	102	25	12.5	10.0	4	14	-	E5365/8NO2
5/8	14	15.88	102	25	12.5	10.0	4	14	-	E5365/8NO3
3/4	12	19.05	112	30	14.0	11.2	4	17	-	E5363/4NO1
3/4	12	19.05	112	30	14.0	11.2	4	17	-	E5363/4NO2
3/4	12	19.05	112	30	14.0	11.2	4	17	-	E5363/4NO3
7/8	11	22.23	118	30	16.0	12.5	4	19.75	-	E5367/8NO1
7/8	11	22.23	118	30	16.0	12.5	4	19.75	-	E5367/8NO2
7/8	11	22.23	118	30	16.0	12.5	4	19.75	-	E5367/8NO3
7/8	11	22.23	118	30	16.0	12.5	4	19.75	-	E5367/8NO6
1"	10	25.40	130	36	18.0	14.0	4	22.75	-	E5361NO1
1"	10	25.40	130	36	18.0	14.0	4	22.75	-	E5361NO2
1"	10	25.40	130	36	18.0	14.0	4	22.75	-	E5361NO3

E539

BSF

ISO
529

Medium



2.5XD

HSS

B
3.5-5



- BSF 机用丝锥 螺尖
- BSF Macho Máquina Ponta Helicoidal
- BSF Machos de máquina Entrada en hélice
- BSF Machine Tap Spiral Point

E539

E539	■	1.1	1.2	1.3	1.4	2.1	2.2	2.3						
	•	1.5	1.6	4.3	5.1	5.2	6.1	6.3	7.1	7.2	7.3	7.4	8.1	



BSF	TPI	d ₁ nom mm	l ₁ mm	l ₂ mm	d ₂ ∅ mm	∠ a mm	z		l ₄ mm	E539
1/4	26	6.35	66	14	6.3	5.0	3	5.3	26	E5391/4
5/16	22	7.94	72	18	8.0	6.3	3	6.8	29	E5395/16
3/8	20	9.53	80	20	10.0	8.0	3	8.3	32	E5393/8
1/2	16	12.70	89	23	9.0	7.1	3	11	-	E5391/2

E538

BSF

ISO
529

Medium



2XD

HSS

C
2-3



- BSF 机用丝锥 螺旋槽 40°
- BSF Macho Máquina Canal Helicoidal 40°
- BSF Machos de máquina Estrías helicoidales a 40°
- BSF Machine Tap Spiral Flute 40°

E538

E538	■	1.2	1.3	1.4	2.1	2.2	2.3
	•	1.5	5.2	7.1	7.2	7.3	7.4



E538



1/4 - 1/2

BSF	TPI	d ₁ nom mm	l ₁ mm	l ₂ mm	d ₂ ∅ mm	□ a mm	z		l ₄ mm	E538
1/4	26	6.350	66	13	6.3	5.00	3	5.3	26	E5381/4 ²⁾
1/4	26	6.350	66	13	6.3	5.00	3	5.3	26	E5381/4BLUE
5/16	22	7.938	72	16	8.0	6.30	3	6.8	31	E5385/16 ²⁾
5/16	22	7.938	72	16	8.0	6.30	3	6.8	31	E5385/16BLUE
3/8	20	9.525	80	18	10.0	8.00	3	8.3	34	E5383/8 ²⁾
3/8	20	9.525	80	18	10.0	8.00	3	8.3	34	E5383/8BLUE
1/2	16	12.700	89	22	9.0	7.10	3	11	-	E5381/2 ²⁾
1/2	16	12.700	89	22	9.0	7.10	3	11	-	E5381/2BLUE

E542

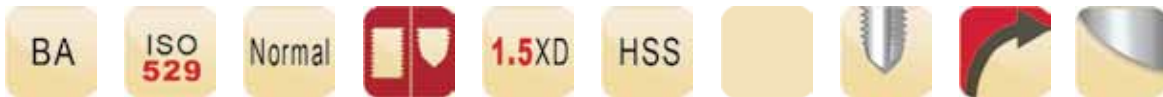

- BA 机用丝锥 直槽
- BA Macho Máquina Canal Reto
- BA Machos de máquina Estrías rectas
- BA Machine Tap Straight Flute

E542

E542	1.1	1.2	1.3	1.4	1.5	3.1	3.2	3.3	3.4	6.1	6.2	6.3	6.4	7.2	7.3	7.4	8.2	8.3
------	-----	-----	-----	-----	-----	-----	-----	-----	-----	-----	-----	-----	-----	-----	-----	-----	-----	-----

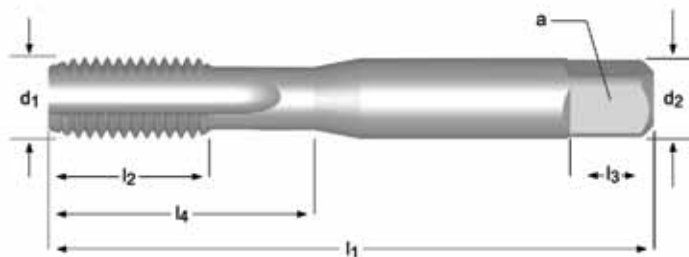

BA	P mm	d ₁ nom mm	l ₁ mm	l ₂ mm	d ₂ Ø mm	□ a mm	l ₃ mm	z		l ₄ mm	E542
BA10	0.35	1.70	41	7.0	2.50	2.0	4	2	1.3	7	E542BA10NO1
BA10	0.35	1.70	41	7.0	2.50	2.0	4	2	1.3	7	E542BA10NO2
BA10	0.35	1.70	41	7.0	2.50	2.0	4	2	1.3	7	E542BA10NO3
BA10	0.35	1.70	41	7.0	2.50	2.0	4	2	1.3	7	E542BA10NO6
BA 8	0.43	2.20	44.5	9.5	2.80	2.2	5	3	1.8	9.5	E542BA8NO1
BA 8	0.43	2.20	44.5	9.5	2.80	2.2	5	3	1.8	9.5	E542BA8NO2
BA 8	0.43	2.20	44.5	9.5	2.80	2.2	5	3	1.8	9.5	E542BA8NO3
BA 8	0.43	2.20	44.5	9.5	2.80	2.2	5	3	1.8	9.5	E542BA8NO6
BA 6	0.53	2.80	44.5	9.5	2.80	2.2	5	3	2.3	9.5	E542BA6NO1
BA 6	0.53	2.80	44.5	9.5	2.80	2.2	5	3	2.3	9.5	E542BA6NO2
BA 6	0.53	2.80	44.5	9.5	2.80	2.2	5	3	2.3	9.5	E542BA6NO3
BA 6	0.53	2.80	44.5	9.5	2.80	2.2	5	3	2.3	9.5	E542BA6NO6
BA 5	0.59	3.20	48	14.5	3.15	2.5	5	3	2.65	14.5	E542BA5NO1
BA 5	0.59	3.20	48	14.5	3.15	2.5	5	3	2.65	14.5	E542BA5NO2
BA 5	0.59	3.20	48	14.5	3.15	2.5	5	3	2.65	14.5	E542BA5NO3
BA 5	0.59	3.20	48	14.5	3.15	2.5	5	3	2.65	14.5	E542BA5NO6
BA 4	0.66	3.60	50	16.5	3.55	2.8	5	3	3	16.5	E542BA4NO1
BA 4	0.66	3.60	50	16.5	3.55	2.8	5	3	3	16.5	E542BA4NO2
BA 4	0.66	3.60	50	16.5	3.55	2.8	5	3	3	16.5	E542BA4NO3
BA 4	0.66	3.60	50	16.5	3.55	2.8	5	3	3	16.5	E542BA4NO6
BA 3	0.73	4.10	53	10.0	4.50	3.5	6	3	3.4	17	E542BA3NO1
BA 3	0.73	4.10	53	10.0	4.50	3.5	6	3	3.4	17	E542BA3NO2
BA 3	0.73	4.10	53	10.0	4.50	3.5	6	3	3.4	17	E542BA3NO3
BA 3	0.73	4.10	53	10.0	4.50	3.5	6	3	3.4	17	E542BA3NO6
BA 2	0.81	4.70	58	12.0	5.00	4.0	7	3	4	20	E542BA2NO1
BA 2	0.81	4.70	58	12.0	5.00	4.0	7	3	4	20	E542BA2NO2
BA 2	0.81	4.70	58	12.0	5.00	4.0	7	3	4	20	E542BA2NO3
BA 2	0.81	4.70	58	12.0	5.00	4.0	7	3	4	20	E542BA2NO6
BA 0	1.00	6.00	66	14.0	6.30	5.0	8	3	5.1	26	E542BA0NO1
BA 0	1.00	6.00	66	14.0	6.30	5.0	8	3	5.1	26	E542BA0NO2
BA 0	1.00	6.00	66	14.0	6.30	5.0	8	3	5.1	26	E542BA0NO3
BA 0	1.00	6.00	66	14.0	6.30	5.0	8	3	5.1	26	E542BA0NO6



E545

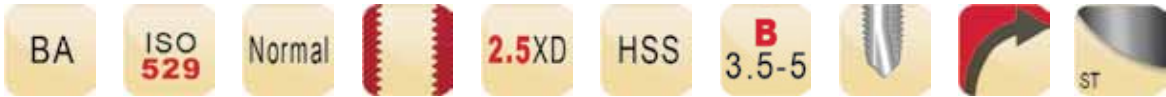

- BA 机用丝锥 螺尖
- BA Macho Máquina Ponta Helicoidal
- BA Machos de máquina Entrada en hélice
- BA Machine Tap Spiral Point

E545

E545	▪	1.1	1.2	1.3	1.4										
	•	1.5	1.6	2.1	2.2	2.3	4.3	5.1	5.2	6.1	6.3	7.1	7.2	7.3	7.4



BA	P mm	d ₁ nom mm	l ₁ mm	l ₂ mm	d ₂ ∅ mm	□ a mm	l ₃ mm	z		l ₄ mm	E545
BA10	0.35	1.70	41	7.0	2.50	2.0	4	2	1.3	7	E545BA10
BA 8	0.43	2.20	44.5	9.5	2.80	2.2	5	3	1.8	9.5	E545BA8
BA 6	0.53	2.80	44.5	9.5	2.80	2.2	5	3	2.3	9.5	E545BA6
BA 4	0.66	3.60	50	16.5	3.55	2.8	5	3	3	16.5	E545BA4
BA 2	0.81	4.70	58	12.0	5.00	4.0	7	3	4	20	E545BA2

E544

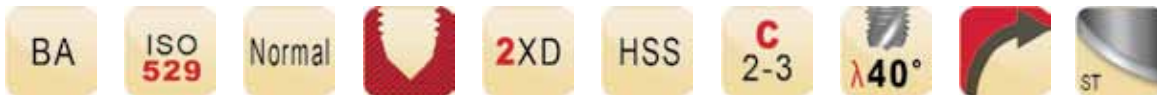

- BA 机用丝锥 螺旋槽 40°
- BA Macho Máquina Canal Helicoidal 40°
- BA Machos de máquina Estrías helicoidales a 40°
- BA Machine Tap Spiral Flute 40°

E544

E544	■	1.2	1.3	1.4	2.1	2.2	2.3
	•	1.5	5.2	7.1	7.2	7.3	7.4

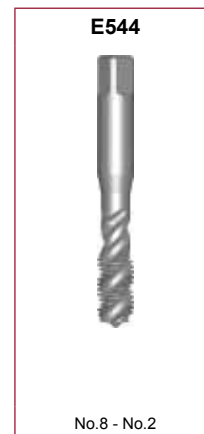

BA	P mm	d ₁ nom mm	l ₁ mm	l ₂ mm	d ₂ Ø mm	∠ a mm	l ₃ mm	z		l ₄ mm	E544
BA 8	0.43	2.20	44.5	9.5	2.80	2.2	5	2	1.8	9.5	E544BA8 ²⁾
BA 8	0.43	2.20	44.5	9.5	2.80	2.2	5	2	1.8	9.5	E544BA8BLUE
BA 6	0.53	2.80	44.5	9.5	2.80	2.2	5	2	2.3	9.5	E544BA6 ²⁾
BA 6	0.53	2.80	44.5	9.5	2.80	2.2	5	2	2.3	9.5	E544BA6BLUE
BA 4	0.66	3.60	50	16.5	3.55	2.8	5	3	3	16.5	E544BA4 ²⁾
BA 4	0.66	3.60	50	16.5	3.55	2.8	5	3	3	16.5	E544BA4BLUE
BA 2	0.81	4.70	58	12.0	5.00	4.0	7	3	4	20	E544BA2 ²⁾
BA 2	0.81	4.70	58	12.0	5.00	4.0	7	3	4	20	E544BA2BLUE

²⁾ 光亮 / Brilhante / Brillante / Bright Finish

E119

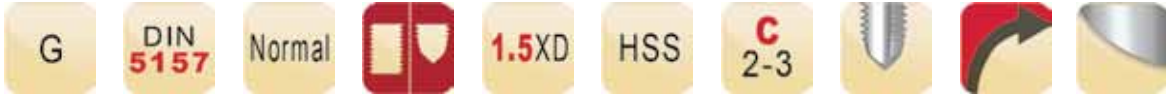

- G(BSP) 手用丝锥 直槽
- G(BSP) Macho Manual Canal Reto
- G(BSP) Machos de mano Estrías rectas
- G(BSP) Hand Tap Straight Flute

E119

E119	•	1.1	1.2	1.3	1.4	1.5	3.1	3.2	3.3	3.4	6.1	6.2	6.3	6.4	7.2	7.3	7.4	8.2	8.3
------	---	-----	-----	-----	-----	-----	-----	-----	-----	-----	-----	-----	-----	-----	-----	-----	-----	-----	-----

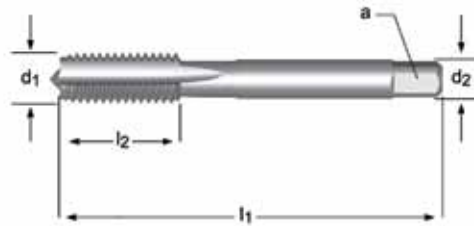

G(BSP)	TPI	d ₁ nom mm	l ₁ mm	l ₂ mm	d ₂ ∅ mm	∠ a mm	z		E119
1/8	28	9.73	63	15	7.0	5.5	3	8.8	E1191/8NO3
1/8	28	9.73	63	15	7.0	5.5	3	8.8	E1191/8NO9
1/4	19	13.16	70	16	11.0	9.0	4	11.8	E1191/4NO3
1/4	19	13.16	70	16	11.0	9.0	4	11.8	E1191/4NO9
3/8	19	16.66	70	16	12.0	9.0	4	15.25	E1193/8NO3
3/8	19	16.66	70	16	12.0	9.0	4	15.25	E1193/8NO9
1/2	14	20.96	80	18	16.0	12.0	4	19	E1191/2NO3
1/2	14	20.96	80	18	16.0	12.0	4	19	E1191/2NO9
5/8	14	22.91	80	22	18.0	14.5	4	21	E1195/8NO3
5/8	14	22.91	80	22	18.0	14.5	4	21	E1195/8NO9
3/4	14	26.44	90	22	20.0	16.0	4	24.5	E1193/4NO3
3/4	14	26.44	90	22	20.0	16.0	4	24.5	E1193/4NO9
7/8	14	30.20	90	22	22.0	18.0	6	28.25	E1197/8NO3
7/8	14	30.20	90	22	22.0	18.0	6	28.25	E1197/8NO9
1"	11	33.25	100	25	25.0	20.0	6	30.75	E1191NO3
1"	11	33.25	100	25	25.0	20.0	6	30.75	E1191NO9
1.1/8	11	37.90	125	40	28.0	22.0	6	35	E1191.1/8NO3
1.1/8	11	37.90	125	40	28.0	22.0	6	35	E1191.1/8NO9
1.1/4	11	41.91	125	40	32.0	24.0	6	39.5	E1191.1/4NO3
1.1/4	11	41.91	125	40	32.0	24.0	6	39.5	E1191.1/4NO9
1.1/2	11	47.80	140	40	36.0	29.0	6	45	E1191.1/2NO3
1.1/2	11	47.80	140	40	36.0	29.0	6	45	E1191.1/2NO9
1.3/4	11	53.75	140	40	40.0	32.0	6	51	E1191.3/4NO3
1.3/4	11	53.75	140	40	40.0	32.0	6	51	E1191.3/4NO9
2"	11	59.61	160	40	45.0	35.0	6	57	E1192NO3
2"	11	59.61	160	40	45.0	35.0	6	57	E1192NO9
2.1/4	11	65.71	160	40	50.0	39.0	6	63	E1192.1/4NO3
2.1/4	11	65.71	160	40	50.0	39.0	6	63	E1192.1/4NO9
2.1/2	11	75.18	160	40	50.0	39.0	6	72.5	E1192.1/2NO3
2.1/2	11	75.18	160	40	50.0	39.0	6	72.5	E1192.1/2NO9
2.3/4	11	81.53	160	40	50.0	39.0	8	79	E1192.3/4NO3
2.3/4	11	81.53	160	40	50.0	39.0	8	79	E1192.3/4NO9
3"	11	87.88	160	40	50.0	39.0	8	85.5	E1193NO3
3"	11	87.88	160	40	50.0	39.0	8	85.5	E1193NO9

E282



- G(BSP) 机用丝锥 直槽
- G(BSP) Macho Máquina Canal Reto
- G(BSP) Machos de máquina Estrías rectas
- G(BSP) Machine Tap Straight Flute

E282

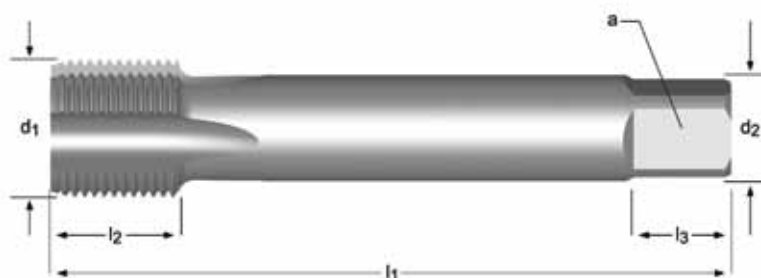

G(BSP)	TPI	d ₁ nom mm	l ₁ mm	l ₂ mm	d ₂ ∅ mm	□ a mm	l ₃ mm	z		E282
1/8	28	9.73	90	20	7.0	5.5	8	3	8.8	E2821/8
1/4	19	13.16	100	21	11.0	9.0	12	4	11.8	E2821/4
3/8	19	16.66	100	21	12.0	9.0	12	4	15.25	E2823/8
1/2	14	20.96	125	24	16.0	12.0	15	4	19.0	E2821/2
5/8	14	22.91	125	25	18.0	14.5	17	4	21.0	E2825/8
3/4	14	26.44	140	28	20.0	16.0	19	4	24.5	E2823/4
7/8	14	30.20	150	28	22.0	18.0	21	4	28.25	E2827/8
1"	11	33.25	160	30	25.0	20.0	23	4	30.75	E2821
1.1/8	11	37.90	170	28	28.0	22.0	25	4	35.0	E2821.1/8
1.1/4	11	41.91	170	30	32.0	24.0	27	4	39.5	E2821.1/4
1.1/2	11	47.80	190	32	36.0	29.0	32	6	45.0	E2821.1/2

E547

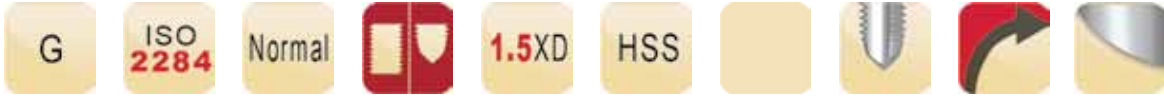

- G(BSP) 机用丝锥 直槽
- G(BSP) Macho Máquina Canal Reto
- G(BSP) Machos de máquina Estrías rectas
- G(BSP) Machine Tap Straight Flute

E547

E547	1.1	1.2	1.3	1.4	1.5	3.1	3.2	3.3	3.4	6.1	6.2	6.3	6.4	7.2	7.3	7.4	8.2	8.3
------	-----	-----	-----	-----	-----	-----	-----	-----	-----	-----	-----	-----	-----	-----	-----	-----	-----	-----

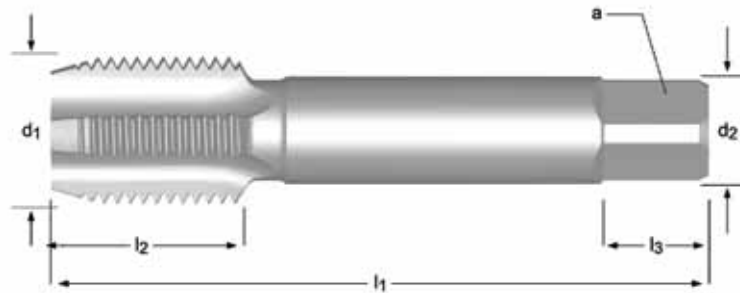

G(BSP)	TPI	d ₁ nom mm	l ₁ mm	l ₂ mm	d ₂ Ø mm	□ a mm	l ₃ mm	z	↔	E547
1/8	28	9.728	59	15	8.0	6.3	9	4	8.8	E5471/8NO1
1/8	28	9.728	59	15	8.0	6.3	9	4	8.8	E5471/8NO2
1/8	28	9.728	59	15	8.0	6.3	9	4	8.8	E5471/8NO3
1/8	28	9.728	59	15	8.0	6.3	9	4	8.8	E5471/8NO7
1/4	19	13.157	67	19	10.0	8.0	11	4	11.8	E5471/4NO1
1/4	19	13.157	67	19	10.0	8.0	11	4	11.8	E5471/4NO2
1/4	19	13.157	67	19	10.0	8.0	11	4	11.8	E5471/4NO3
1/4	19	13.157	67	19	10.0	8.0	11	4	11.8	E5471/4NO7
3/8	19	16.662	75	21	12.5	10.0	13	4	15.25	E5473/8NO1
3/8	19	16.662	75	21	12.5	10.0	13	4	15.25	E5473/8NO2
3/8	19	16.662	75	21	12.5	10.0	13	4	15.25	E5473/8NO3
3/8	19	16.662	75	21	12.5	10.0	13	4	15.25	E5473/8NO7
1/2	14	20.955	87	26	16.0	12.5	16	4	19	E5471/2NO1
1/2	14	20.955	87	26	16.0	12.5	16	4	19	E5471/2NO2
1/2	14	20.955	87	26	16.0	12.5	16	4	19	E5471/2NO3
1/2	14	20.955	87	26	16.0	12.5	16	4	19	E5471/2NO7
5/8	14	22.911	91	26	18.0	14.0	18	4	21	E5475/8NO1
5/8	14	22.911	91	26	18.0	14.0	18	4	21	E5475/8NO2
5/8	14	22.911	91	26	18.0	14.0	18	4	21	E5475/8NO3
5/8	14	22.911	91	26	18.0	14.0	18	4	21	E5475/8NO7
3/4	14	26.441	96	28	20.0	16.0	20	4	24.5	E5473/4NO1
3/4	14	26.441	96	28	20.0	16.0	20	4	24.5	E5473/4NO2
3/4	14	26.441	96	28	20.0	16.0	20	4	24.5	E5473/4NO3
3/4	14	26.441	96	28	20.0	16.0	20	4	24.5	E5473/4NO7
7/8	14	30.201	102	29	22.4	18.0	22	4	28.25	E5477/8NO1
7/8	14	30.201	102	29	22.4	18.0	22	4	28.25	E5477/8NO2
7/8	14	30.201	102	29	22.4	18.0	22	4	28.25	E5477/8NO3
1"	11	33.249	109	33	25.0	20.0	24	4	30.75	E5471NO1
1"	11	33.249	109	33	25.0	20.0	24	4	30.75	E5471NO2
1"	11	33.249	109	33	25.0	20.0	24	4	30.75	E5471NO3
1.1/4	11	41.910	119	36	31.5	25.0	28	6	39.5	E5471.1/4NO1
1.1/4	11	41.910	119	36	31.5	25.0	28	6	39.5	E5471.1/4NO2
1.1/4	11	41.910	119	36	31.5	25.0	28	6	39.5	E5471.1/4NO3
1.1/2	11	47.803	125	37	35.5	28.0	31	6	45	E5471.1/2NO1
1.1/2	11	47.803	125	37	35.5	28.0	31	6	45	E5471.1/2NO2
1.1/2	11	47.803	125	37	35.5	28.0	31	6	45	E5471.1/2NO3
2"	11	59.614	140	41	40.0	31.5	34	6	57	E5472NO1
2"	11	59.614	140	41	40.0	31.5	34	6	57	E5472NO2
2"	11	59.614	140	41	40.0	31.5	34	6	57	E5472NO3



- EP40**
- G(BSP) 机用丝锥 螺尖
 - G(BSP) Macho Máquina Ponta Helicoidal
- EP41**
- G(BSP) Machos de máquina Entrada en hélice
 - G(BSP) Machine Tap Spiral Point

EP40	▪	1.1	1.2	1.3	1.4	1.5	6.1	6.3	7.1	7.2	7.3	7.4	
	•	1.6	3.1	3.2	3.3	3.4	4.1	4.2	5.1	5.2	6.2	8.1	
EP41	▪	1.1	1.2	1.3	1.4	1.5							
	•	1.6	2.1	2.2	2.3	3.1	3.2	3.3	3.4				

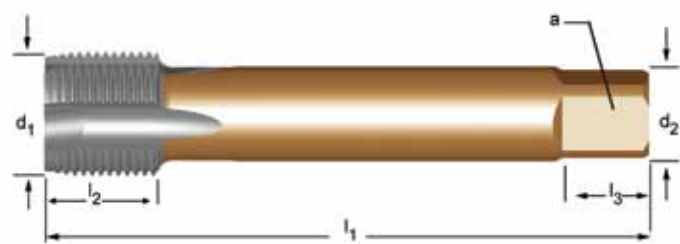

G(BSP)	TPI	d ₁ nom mm	l ₁ mm	l ₂ mm	d ₂ Ø mm	□ a mm	l ₃ mm	z		EP40	EP41
1/8	28	9.728	90	18	7.0	5.5	8	3	8.8	EP401/8	EP411/8
1/4	19	13.157	100	21	11.0	9.0	12	3	11.8	EP401/4	EP411/4
3/8	19	16.662	100	21	12.0	9.0	12	4	15.25	EP403/8	EP413/8
1/2	14	20.955	125	24	16.0	12.0	15	4	19	EP401/2	EP411/2
5/8	14	22.911	125	24	18.0	14.5	17	4	21	EP405/8	EP415/8
3/4	14	26.441	140	28	20.0	16.0	19	4	24.5	EP403/4	EP413/4
7/8	14	30.201	150	28	22.0	18.0	21	4	28.25	EP407/8	EP417/8
1"	11	33.249	160	30	25.0	20.0	23	4	30.75	EP401	EP411

E041



- G(BSP) 机用丝锥 螺尖
- G(BSP) Macho Máquina Ponta Helicoidal
- G(BSP) Machos de máquina Entrada en hélice
- G(BSP) Machine Tap Spiral Point

E041

E041	▪	1.1	1.2	1.3	1.4	1.5				
	•	1.6	2.1	2.2	2.3	3.1	3.2	3.3	3.4	



G(BSP)	TPI	d ₁ nom mm	l ₁ mm	l ₂ mm	d ₂ ∅ mm	□ a mm	l ₃ mm	z		E041
1/8	28	9.728	90	15	8.0	6.3	9	3	8.80	E0411/8
1/4	19	13.157	100	19	10.0	8.0	11	3	11.80	E0411/4
3/8	19	16.662	100	21	12.5	10.0	13	3	15.25	E0413/8
1/2	14	20.955	125	26	16.0	12.5	16	4	19.00	E0411/2
3/4	14	26.441	140	28	20.0	16.0	20	4	24.50	E0413/4



- EX40**
- G(BSP) 机用丝锥 螺旋槽 45°
 - G(BSP) Macho Máquina Canal Helicoidal 45°
- EX41**
- G(BSP) Machos de máquina Estrías helicoidales a 45°
 - G(BSP) Machine Tap Spiral Flute 45°

EX40	▪	1.1	1.2	1.3	1.4	1.5	7.1	7.2	7.3	7.4
	•	4.1	4.2	5.1	5.2	8.1				
EX41	▪	1.1	1.2	1.3	1.4	1.5	2.1	2.2		
	•	2.3								

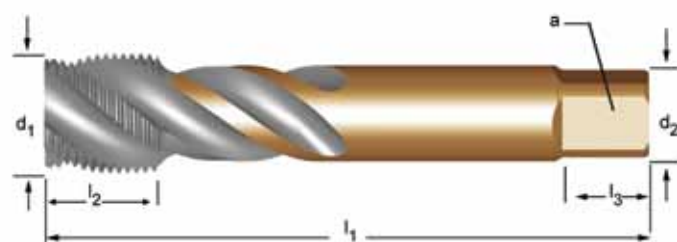

G(BSP)	TPI	d ₁ nom mm	l ₁ mm	l ₂ mm	d ₂ Ø mm	a mm	l ₃ mm	z		EX40	EX41
1/8	28	9.728	90	13	7.0	5.5	8	3	8.8	EX401/8	EX411/8
1/4	19	13.157	100	15	11.0	9.0	12	3	11.8	EX401/4	EX411/4
3/8	19	16.662	100	15	12.0	9.0	12	4	15.25	EX403/8	EX413/8
1/2	14	20.955	125	18	16.0	12.0	15	4	19	EX401/2	EX411/2
5/8	14	22.911	125	18	18.0	14.5	17	4	21	EX405/8	EX415/8
3/4	14	26.441	140	20	20.0	16.0	19	4	24.5	EX403/4	EX413/4
7/8	14	30.201	150	20	22.0	18.0	21	4	28.25	EX407/8	EX417/8
1"	11	33.249	160	22	25.0	20.0	23	4	30.75	EX401	EX411
1.1/8	11	37.897	170	22	28.0	22.0	25	4	35	EX401.1/8	EX411.1/8
1.1/4	11	41.910	170	22	32.0	24.0	27	4	39.5	EX401.1/4	EX411.1/4
1.1/2	11	47.803	190	23	36.0	29.0	32	4	45	EX401.1/2	EX411.1/2

E382



E382

- G (BSP) 机用螺旋槽40°丝锥，蓝圈鲨鱼丝锥
- G(BSP) Macho Máquina Canal Helicoidal 40° Shark - Anel Azul
- G(BSP) Macho de máquina helicoidal 40° Shark (Anillo Azul)
- G(BPS) Machine Tap Spiral Flute 40°, Blue Shark

提供HSS-E，直到新的可用库存

Fornecido em HSS-E até disponibilidade do novo estoque
 Suministrado en HSS-E hasta disponibilidad de nuevo stock
 Supplied in HSS-E until new stock available

E382	■	2.1	2.2	2.3
	•	1.5	1.6	

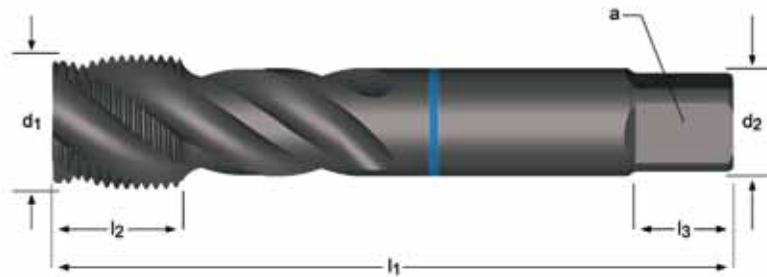

G(BSP)	TPI	d ₁ nom mm	l ₁ mm	l ₂ mm	d ₂ Ø mm	∠ a mm	l ₃ mm	z		E382
1/8	28	9.73	90	12	7.0	5.5	8	3.0	8.8	E3821/8
1/4	19	13.16	100	15	11.0	9.0	12	4.0	11.8	E3821/4
3/8	19	16.66	100	15	12.0	9.0	12	4.0	15.25	E3823/8
1/2	14	20.96	125	24	16.0	12.0	15	4.0	19.0	E3821/2
3/4	14	26.44	140	20	20.0	16.0	19	4.0	24.5	E3823/4
1"	11	33.25	160	24	25.0	20.0	23	4.0	30.75	E3821

E043



- G(BSP) 机用丝锥 螺旋槽 45°
- G(BSP) Macho Máquina Canal Helicoidal 45°
- G(BSP) Machos de máquina Estrías helicoidales a 45°
- G(BSP) Machine Tap Spiral Flute 45°

E043

E043	▪	1.1	1.2	1.3	1.4	1.5
	•	1.6	2.1	2.2	2.3	



G(BSP)	TPI	d ₁ nom mm	l ₁ mm	l ₂ mm	d ₂ Ø mm	∠ a mm	l ₃ mm	z		E043
1/8	28	9.728	90	15	8.0	6.3	9	3	8.80	E0431/8
1/4	19	13.157	100	19	10.0	8.0	11	3	11.80	E0431/4
3/8	19	16.662	100	21	12.5	10.0	13	4	15.25	E0433/8
1/2	14	20.955	125	26	16.0	12.5	16	4	19.00	E0431/2
3/4	14	26.441	140	28	20.0	16.0	20	4	24.50	E0433/4

E620

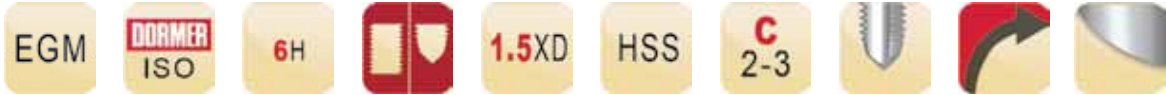

- EGM 机用丝锥 直槽
- EGM Macho Máquina Canal Reto
- EGM Machos de máquina Estrías rectas
- EGM Machine Tap Straight Flute

E620

E620 • 1.1 1.2 1.3 1.4 1.5 3.1 3.2 3.3 3.4 6.1 6.2 6.3 6.4 7.2 7.3 7.4 8.2 8.3

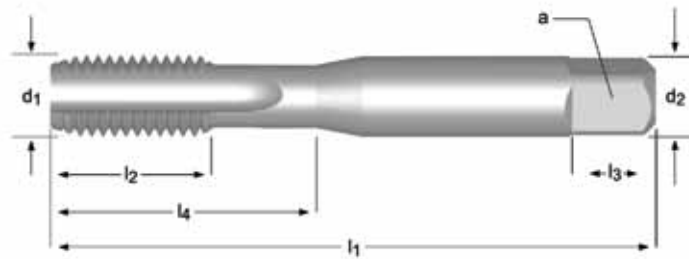

M	P mm	d ₁ nom mm	l ₁ mm	l ₂ mm	d ₂ Ø mm	□ a mm	l ₃ mm	z		l ₄ mm	E620
3	0.50	3.65	53	14	4.0	3.15	6	3	3.2	14	E620M3
4	0.70	4.91	58	11	5.0	4.00	7	3	4.2	20	E620M4
5	0.80	6.04	66	13	6.3	5.00	8	3	5.2	26	E620M5
6	1.00	7.30	72	16	8.0	6.30	9	3	6.3	29	E620M6
8	1.25	9.62	80	18	10.0	8.00	11	3	8.4	32	E620M8
10	1.50	11.95	89	22	9.0	7.10	10	3	10.5	-	E620M10
12	1.75	14.27	95	24	11.2	9.00	12	4	12.5	-	E620M12
14	2.00	16.60	112	29	14.0	11.20	14	4	14.5	-	E620M14
16	2.00	18.60	112	29	14.0	11.20	14	4	16.5	-	E620M16

E621

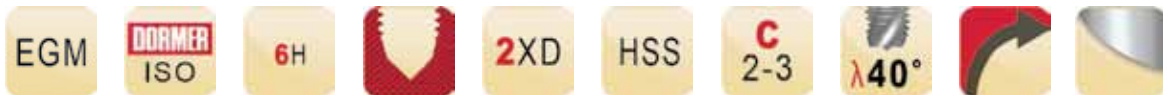

- EGM 机用丝锥 螺旋槽 40°
- EGM Macho Máquina Canal Helicoidal 40°
- EGM Machos de máquina Estrías helicoidales a 40°
- EGM Machine Tap Spiral Flute 40°

E621

E621 • 1.2 1.3 1.4 1.5 2.1 2.2 2.3 5.2 7.1 7.2 7.3 7.4



E621



M3 - M16

M	P mm	d ₁ nom mm	l ₁ mm	l ₂ mm	d ₂ ∅ mm	□ a mm	l ₃ mm	z		l ₄ mm	E621
3	0.50	3.65	53	14	4.0	3.15	6	3	3.2	14	E621M3
4	0.70	4.91	58	11	5.0	4.00	7	3	4.2	20	E621M4
5	0.80	6.04	66	13	6.3	5.00	8	3	5.2	26	E621M5
6	1.00	7.30	72	16	8.0	6.30	9	3	6.3	31	E621M6
8	1.25	9.62	80	18	10.0	8.00	11	3	8.4	34	E621M8
10	1.50	11.95	89	22	9.0	7.10	10	3	10.5	-	E621M10
12	1.75	14.27	95	24	11.2	9.00	12	3	12.5	-	E621M12
14	2.00	16.60	112	29	14.0	11.20	14	3	14.5	-	E621M14
16	2.00	18.60	112	29	14.0	11.20	14	3	16.5	-	E621M16

E550

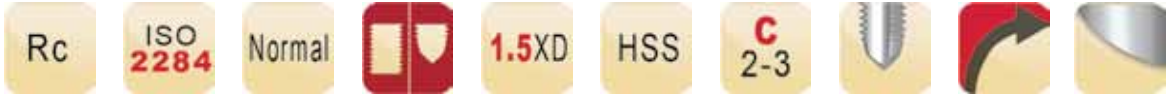

- Rc 机用丝锥 直槽
- Rc Macho Máquina Canal Reto
- Rc Machos de máquina Estrías rectas
- Rc Machine Tap Straight Flute

E550

E550	▪	3.1	3.2	3.3	3.4	6.1											
	•	1.1	1.2	1.3	1.4	1.5	1.6	2.1	2.2	2.3	6.2	6.3	6.4	7.2	7.3	7.4	8.2

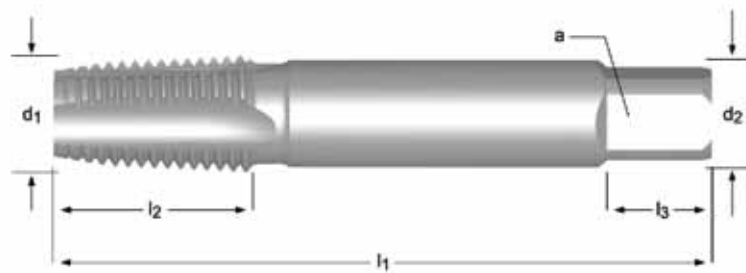

Rc	TPI	d ₁ nom mm	l ₁ mm	l ₂ mm	d ₂ Ø mm	□ a mm	l ₃ mm	z		E550
1/8	28	9.728	59	15	8.0	6.3	9	3	8.4	E5501/8
1/8	28	9.728	59	15	8.0	6.3	9	3	8.4	E5501/8NO7
1/4	19	13.157	67	19	10.0	8.0	11	3	11.2	E5501/4
1/4	19	13.157	67	19	10.0	8.0	11	3	11.2	E5501/4NO7
3/8	19	16.662	75	21	12.5	10.0	13	3	14.75	E5503/8
3/8	19	16.662	75	21	12.5	10.0	13	3	14.75	E5503/8NO7
1/2	14	20.955	87	26	16.0	12.5	16	5	18.25	E5501/2
1/2	14	20.955	87	26	16.0	12.5	16	5	18.25	E5501/2NO7
3/4	14	26.441	96	28	20.0	16.0	20	5	23.75	E5503/4
3/4	14	26.441	96	28	20.0	16.0	20	5	23.75	E5503/4NO7
1"	11	33.249	109	33	25.0	20.0	24	5	30	E5501
1.1/4	11	41.910	119	36	31.5	25.0	28	5	38.5	E5501.1/4
1.1/2	11	47.803	125	37	35.5	28.0	31	7	44.5	E5501.1/2
2"	11	59.614	140	41	40.0	31.5	34	7	56	E5502

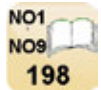

E714

NPT



Normal



1.5XD

HSS-E

C
2-3



E714

- NPT 机用丝锥 直槽
- NPT Macho Máquina Canal Reto
- NPT Machos de máquina Estrías rectas
- NPT Machine Tap Straight Flute

E714 ■ **1.3 1.4**
 • **1.1 1.2 1.5 3.1 3.2 3.3 3.4 6.2 7.3 7.4 8.1**

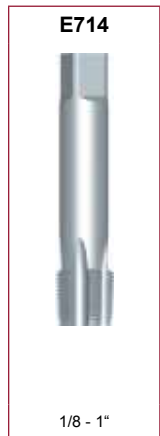
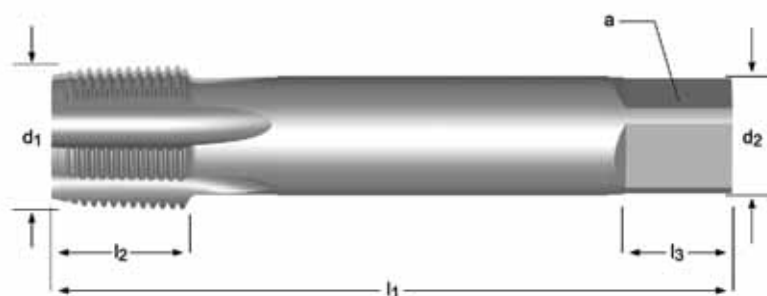

NPT	TPI	d ₁ nom mm	l ₁ mm	l ₂ mm	d ₂ ∅ mm	∠ a mm	l ₃ mm	z		E714
1/8	27	10.23	90	14	11.0	9.0	12	3	8.5	E7141/8
1/4	18	13.60	100	20	14.0	11.0	14	3	11	E7141/4
3/8	18	17.04	110	20	16.0	12.0	15	4	14.5	E7143/8
1/2	14	21.20	125	26	18.0	14.5	17	4	18	E7141/2
3/4	14	26.54	140	26	22.0	18.0	21	5	23	E7143/4
1"	11.5	33.20	150	31	28.0	22.0	25	5	29	E7141



- E710**
- NPT 机用丝锥 直槽
 - NPT Macho Máquina Canal Reto
- E721**
- NPT Machos de máquina Estrías rectas
 - NPT Machine Tap Straight Flute

E710	•	1.1	1.2	1.3	1.4	1.5	3.1	3.2	3.3	3.4	6.2	7.3	7.4	8.1
E721	▪	1.3	1.4	3.1	3.2	3.3	3.4							
	•	1.1	1.2	1.5	6.2	7.3	7.4	8.1						

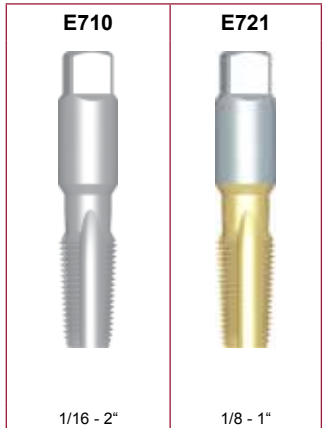
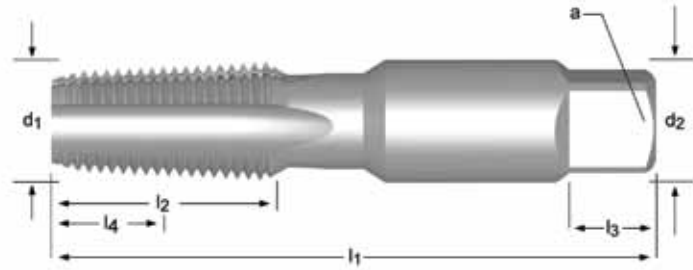

NPT	TPI	d ₁ nom mm	l ₁ mm	l ₂ mm	l ₄ mm	d ₂ Ø mm	□ a mm	l ₃ mm	z		E710	E721
1/16	27	7.94	65	17	11.7	8.1	6.0	8	4	6.3	E7101/16NO3	
1/8	27	10.29	70	19	11.9	11.1	8.3	10	4	8.5	E7101/8	E7211/8
1/8	27	10.29	70	19	11.9	11.1	8.3	10	4	8.5	E7101/8NO7	
1/4	18	13.72	75	27	17.6	14.3	10.7	11	4	11.0	E7101/4	E7211/4
1/4	18	13.72	75	27	17.6	14.3	10.7	11	4	11.0	E7101/4NO7	
3/8	18	17.15	80	27	19.5	17.8	13.5	13	4	14.5	E7103/8	E7213/8
3/8	18	17.15	80	27	19.5	17.8	13.5	13	4	14.5	E7103/8NO7	
1/2	14	21.34	100	35	22.7	17.5	13.1	16	4	18.0	E7101/2	E7211/2
1/2	14	21.34	100	35	22.7	17.5	13.1	16	4	18.0	E7101/2NO7	
3/4	14	26.67	105	35	24.4	23.0	17.2	17	5	23.0	E7103/4	E7213/4
3/4	14	26.67	105	35	24.4	23.0	17.2	17	5	23.0	E7103/4NO7	
1"	11.5	33.40	115	43	29.4	28.6	21.4	21	5	29.0	E7101	E7211
1.1/4	11.5	42.16	125	43	27.7	33.3	25.0	24	5	38.0	E7101.1/4	
1.1/2	11.5	48.26	135	43	28.9	38.1	28.6	25	7	44.0	E7101.1/2	
2"	11.5	60.33	145	43	26.6	47.6	35.7	29	7	56.0	E7102	

E711

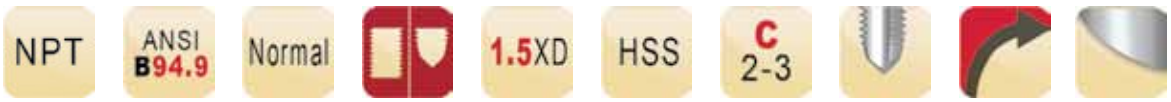

- NPT 跳牙机用丝锥 直槽
- NPT Macho Máquina, Rosca Interrompida Canal Reto
- NPT Machos de máquina, dientes alternos Estrías rectas
- NPT Machine Tap, Interrupted Threads Straight Flute

E711

E711	▪	1.3	1.4									
	•	1.1	1.2	1.5	3.1	3.2	3.3	3.4	6.2	7.3	7.4	8.1

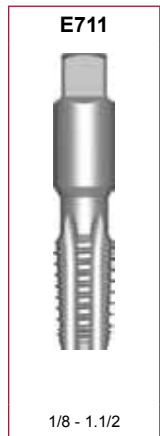
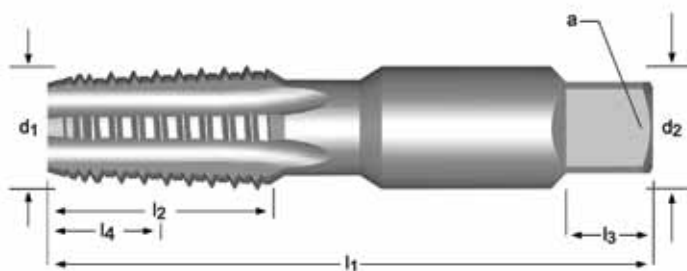

NPT	TPI	d ₁ nom mm	l ₁ mm	l ₂ mm	l ₄ mm	d ₂ Ø mm	∇ a mm	l ₃ mm	z		E711
1/8	27	10.29	70	19	11.9	11.1	8.3	10	5	8.5	E7111/8
1/4	18	13.72	75	27	17.6	14.3	10.7	11	5	11.0	E7111/4
3/8	18	17.15	80	27	19.5	17.8	13.5	13	5	14.5	E7113/8
1/2	14	21.33	100	35	22.7	17.5	13.1	16	5	18.0	E7111/2
3/4	14	26.67	105	35	24.4	23.0	17.2	17	5	23.0	E7113/4
1"	11.5	33.40	115	43	29.4	28.6	21.4	21	5	29.0	E71111
1.1/2	11.5	48.26	135	43	28.9	38.1	28.6	25	7	44.0	E7111.1/2

E653

NPT

ANSI

Normal



1.5XD

HSS



- NPT 钻攻复合刀具 螺旋槽 27°
- NPT Broca-Macho Canal Helicoidal 27°
- NPT Combinación broca-macho Estrías helicoidales a 27°
- NPT Combi Taps Spiral Flute 27°

E653

E653 • 1.1 1.2 1.3 1.4 3.2 6.2 6.3 7.1 7.2 8.1

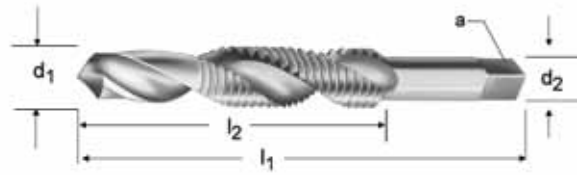

E653



1/8 - 1"

NPT	TPI	d ₁ nom Inch	l ₁ Inch	l ₂ Inch	d ₂ ∅ Inch	∠ a Inch	z	E653
1/8	27	0.3346	2.7/8	3/4	0.4370	0.3280	2	E6531/8
1/4	18	0.4331	3.5/16	1.1/16	0.5620	0.4210	2	E6531/4
3/8	18	0.5709	3.1/2	1.1/16	0.7000	0.5310	2	E6533/8
1/2	14	0.7087	4.3/8	1.3/8	0.6870	0.5150	2	E6531/2
3/4	14	0.9055	4.9/16	1.3/8	0.9060	0.6790	2	E6533/4
1"	11.5	1.1417	5.3/8	1.3/4	1.1250	0.8430	2	E6531

E712

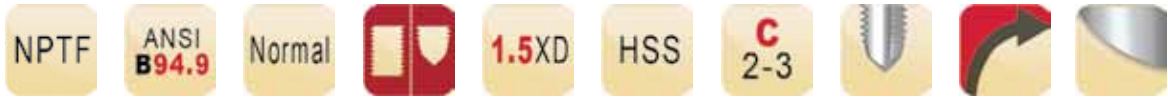

- NPTF 机用丝锥 直槽
- NPTF Macho Máquina Canal Reto
- NPTF Machos de máquina Estrías rectas
- NPTF Machine Tap Straight Flute

E712

E712 ■ 1.3 1.4
 • 1.1 1.2 1.5 3.1 3.2 3.3 3.4 6.2 7.3 7.4 8.1

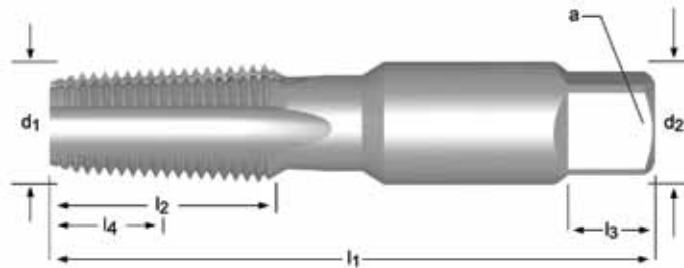

NPTF	TPI	d ₁ nom mm	l ₁ mm	l ₂ mm	l ₄ mm	d ₂ Ø mm	□ a mm	l ₃ mm	z		E712
1/16	27	7.94	65	17	11.7	8.1	6.0	8	4	6.20	E7121/16
1/8	27	10.29	70	19	11.9	11.1	8.3	10	4	8.40	E7121/8
1/4	18	13.72	75	27	17.6	14.3	10.7	11	4	10.90	E7121/4
3/8	18	17.15	80	27	19.5	17.8	13.5	13	4	14.25	E7123/8
1/2	14	21.34	100	35	22.7	17.5	13.1	16	4	17.75	E7121/2
3/4	14	26.67	105	35	24.4	23.0	17.2	17	5	23.00	E7123/4
1"	11.5	33.40	115	43	29.4	28.6	21.4	21	5	29.00	E7121
1.1/4	11.5	42.16	125	43	27.7	33.4	24.9	23	5	37.75	E7121.1/4

E709	NPSF	ANSI B94.9	Normal		1.5XD	HSS	C 2-3			
E720	NPSF	ANSI B94.9	Normal		1.5XD	HSS	C 2-3			TIN

- E709**
- NPSF 机用丝锥 直槽
 - NPSF Macho Máquina Canal Reto
- E720**
- NPSF Machos de máquina Estrías rectas
 - NPSF Machine Tap Straight Flute

E709	▪	1.3	1.4									
	•	1.1	1.2	1.5	3.1	3.2	3.3	3.4	6.2	7.3	7.4	8.1
E720	▪	1.3	1.4	3.1	3.2	3.3	3.4					
	•	1.1	1.2	1.5	6.2	7.3	7.4	8.1				

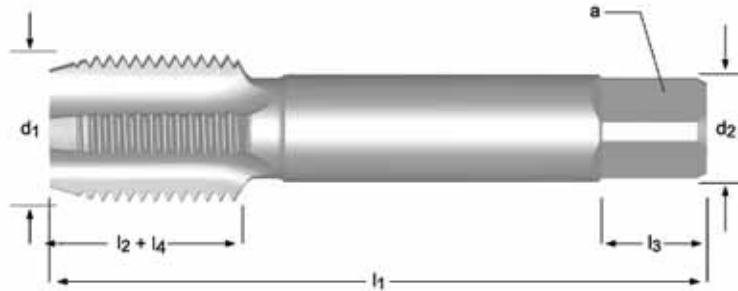

NPSF	TPI	d ₁ nom mm	l ₁ mm	l ₂ mm	l ₄ mm	d ₂ ∅ mm	a mm	l ₃ mm	z		E709	E720
1/8	27	10.29	70	19	19	11.1	8.3	10	4	8.70	E7091/8	E7201/8NO3
1/4	18	13.72	75	27	27	14.3	10.7	11	4	11.30	E7091/4	E7201/4NO3
3/8	18	17.15	80	27	27	17.8	13.5	13	4	14.75	E7093/8	E7203/8NO3
1/2	14	21.34	100	35	-	17.5	13.1	16	4	18.25	E7091/2	E7201/2NO3
3/4	14	26.67	105	35	-	23.0	17.2	17	5	23.50	E7093/4	E7203/4NO3

NO1
NO3
198

E708

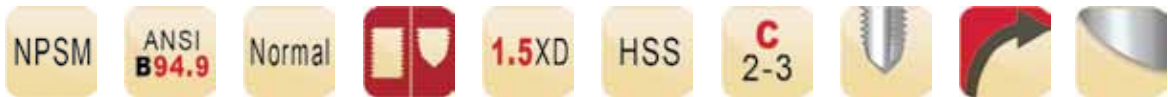

- NPSM 机用丝锥 直槽
- NPSM Macho Máquina Canal Reto
- NPSM Machos de máquina Estrías rectas
- NPSM Machine Tap Straight Flute

E708

E708 ■ **1.3 1.4**
 • **1.1 1.2 1.5 3.1 3.2 3.3 3.4 6.2 7.3 7.4 8.1**

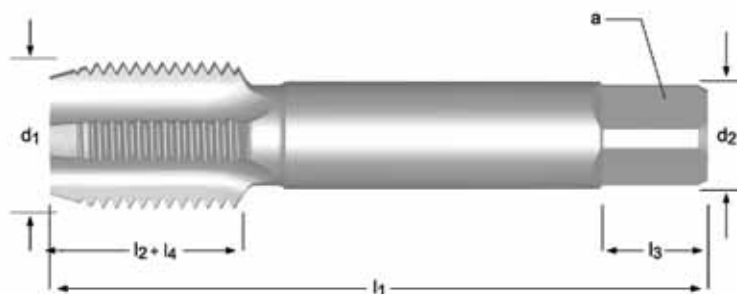

NPSM	TPI	d ₁ nom mm	l ₁ mm	l ₂ mm	l ₄ mm	d ₂ Ø mm	□ a mm	l ₃ mm	z		E708
1/8	27	10.29	70	19	19	11.1	8.3	10	4	9.1	E7081/8
1/4	18	13.72	75	27	27	14.3	10.7	11	4	12.0	E7081/4
3/8	18	17.15	80	27	27	17.8	13.5	13	4	15.5	E7083/8
1/2	14	21.33	100	35	-	17.5	13.1	16	4	19.0	E7081/2
3/4	14	26.67	105	35	-	23.0	17.2	17	5	24.5	E7083/4
1"	11.5	33.40	115	43	-	28.6	21.4	21	5	30.5	E7081

E243

PG

DIN
40432

Normal



1.5XD

HSS



- PG 机用丝锥 直槽
- PG Macho Máquina Canal Reto
- PG Machos de máquina Estrías rectas
- PG Machine Tap Straight Flute

E243

E243 • 1.1 1.2 1.3 1.4 1.5 3.1 3.2 3.3 6.2 6.3 7.2 7.3 8.2

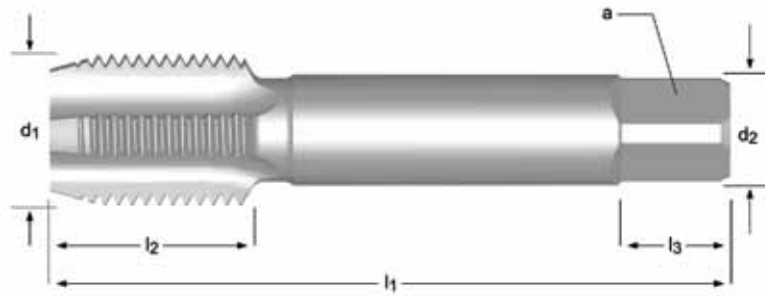

E243



No.7 - No.36

PG	TPI	d ₁ nom mm	l ₁ mm	l ₂ mm	d ₂ Ø mm	∠ a mm	l ₃ mm	z		E243
7	20	12.5	70	22	9.0	7.0	10	4	11.4	E243PG7NO2
7	20	12.5	70	22	9.0	7.0	10	4	11.4	E243PG7NO3
9	18	15.2	70	22	12.0	9.0	12	4	13.9	E243PG9NO2
9	18	15.2	70	22	12.0	9.0	12	4	13.9	E243PG9NO3
11	18	18.6	80	22	14.0	11.0	14	4	17.25	E243PG11NO2
11	18	18.6	80	22	14.0	11.0	14	4	17.25	E243PG11NO3
13.5	18	20.4	80	22	16.0	12.0	15	4	19	E243PG13.5NO2
13.5	18	20.4	80	22	16.0	12.0	15	4	19	E243PG13.5NO3
16	18	22.5	80	22	18.0	14.5	17	4	21.25	E243PG16NO2
16	18	22.5	80	22	18.0	14.5	17	4	21.25	E243PG16NO3
21	16	28.3	90	22	22.0	18.0	21	4	27	E243PG21NO2
21	16	28.3	90	22	22.0	18.0	21	4	27	E243PG21NO3
29	16	37.0	100	25	28.0	22.0	25	6	35.5	E243PG29NO2
29	16	37.0	100	25	28.0	22.0	25	6	35.5	E243PG29NO3
36	16	47.0	140	32	36.0	29.0	32	6	45.5	E243PG36NO2
36	16	47.0	140	32	36.0	29.0	32	6	45.5	E243PG36NO3

NO1
NO9
198

L110

- 板牙扳手
- Desandador para Cossinetes
- Maneta para Terrajas " Portaterrajas"
- Die Stocks



Nr.	Ø x H	L110
1"	16 x 5	L1101
2a	20 x 5	L1102A
2b	20 x 7	L1102B
3	25 x 9	L1103
4"	30 x 11	L1104
5	38 x 14	L1105
5f	38 x 10	L1105F
6	45 x 18	L1106
6f	45 x 14	L1106F
7	55 x 22	L1107
7f	55 x 16	L1107F
8	65 x 25	L1108
8f	65 x 18	L1108F
9	75 x 30	L1109
9f	75 x 20	L1109F
10	90 x 36	L11010
10f	90 x 22	L11010F
	13/16 x 1/4	L11013/16
	1 x 3/8	L1101INCH
	1.5/16 x 7/16	L1101.5/16
	1.1/2 x 1/2	L1101.1/2
	2 x 5/8	L1102INCH
	2.1/4 x 11/16	L1102.1/4
	3 x 7/8	L1103INCH
	4 x 1	L1104INCH

L111

- 丝锥扳手
- Desandador Ajustável
- Portamachos regulable
- Tap Wrenches

L120
309



Nr.	☑	L111
0	2.0 - 5.0	L111NO0
1	2.1 - 8.0	L111NO1
2	4.9 - 12.0	L111NO2
3	5.5 - 16.0	L111NO3
4	11.0 - 24.0	L111NO4
5	16.0 - 32.0	L111NO5
BT1	1.0 - 6.5	L111BT1
BT2	1.0 - 10.0	L111BT2

L119

- 公制粗牙丝锥套装
- Jogo de Machos Métricos em Caixa Metálica
- Machos Métricos, cx. Metálica
- Metric Coarse Taps Set

A=套装形式, B=套装数量, M=套装里的丝锥直径

A=Tipos no jogo, B=No. no jogo, M=Diâmetros de Machos no jogo

A = Tipos en el juego, B=No. en el Juego, M= Diámetros Machos en el Juego

A=Styles in Set, B=No. in Set, M=Tap diameters in Set



Nr.	A	B	M	L119
Nr.17	E100	21	E100M3NO3, E100M3NO4, E100M3NO5, E100M4NO3, E100M4NO4, E100M4NO5, E100M5NO3, E100M5NO4, E100M5NO5, E100M6NO3, E100M6NO4, E100M6NO5, E100M8NO3, E100M8NO4, E100M8NO5, E100M10NO3, E100M10NO4, E100M10NO5, E100M12NO3, E100M12NO4, E100M12NO5	L11917

L126

- 组合丝锥套装
- Jogo de Brocas Macho em Caixa Metalica
- Conjunto de Macho Broca
- Combi Taps Set

A=套装形式, B=套装数量, M=套装里的丝锥直径

A=Tipos no jogo, B=N° eno jogo, M=Diâmetros de Machos no jogo

A = Tipos en el juego, B=No. no Jogo, M= Diámetros Machos en el Juego

A=Styles in Set, B=No. in Set, M=Tap diameters in Set



Nr.	A	B	M	L126
650	E650	6	E650M4, E650M5, E650M6, E650M8, E650M10, E650M12	L126650

L113

- ISO 丝锥-钻头套装 A= 套装形式, B=套装数量, M= 套装里的丝锥直径, D= 套装里的钻头直径
- ISO Jogo de Broca + Macho A=Tipos no jogo, B=Nº eno jogo, M=Diâmetros de Machos no jogo, D= Diâmetros de Brocas no jogo
- ISO Juego de Broca-Macho A = Tipos en el juego, B=No. no Jogo, M= Diámetros Machos en el Juego, D= Diámetros Brocas en el Juego
- ISO Tap-Drill Set A= Styles in Set, B= No. in Set, M= Tap diameters in Set, D= Drill diameters in Set



Nr.	A	B	M	D	L113
Nr.201	E000 + A002	14	E000M3, E000M4, E000M5, E000M6, E000M8, E000M10, E000M12	A0022.5, A0023.3, A0024.2, A0025.0, A0026.8, A0028.5, A00210.2	L113201
Nr.202	E001 + A002	14	E001M3, E001M4, E001M5, E001M6, E001M8, E001M10, E001M12	A0022.5, A0023.3, A0024.2, A0025.0, A0026.8, A0028.5, A00210.2	L113202
Nr.203	E002 + A002	14	E002M3, E002M4, E002M5, E002M6, E002M8, E002M10, E002M12	A0022.5, A0023.3, A0024.2, A0025.0, A0026.8, A0028.5, A00210.2	L113203
Nr.204	E003 + A002	14	E003M3, E003M4, E003M5, E003M6, E003M8, E003M10, E003M12	A0022.5, A0023.3, A0024.2, A0025.0, A0026.8, A0028.5, A00210.2	L113204

L114

- DIN丝锥-钻头套装 A= 套装形式, B=套装数量, M= 套装里的丝锥直径, D= 套装里的钻头直径
- DIN Jogo de Broca + Macho A=Tipos no jogo, B=N° eno jogo, M=Diâmetros de Machos no jogo, D= Diâmetros de Brocas no jogo
- DIN Juego de Broca-Macho A = Tipos en el juego, B=No. no Jogo, M= Diámetros Machos en el Juego, D= Diámetros Brocas en el Juego
- DIN Tap-Drill Set A= Styles in Set, B= No. in Set, M= Tap diameters in Set, D= Drill diameters in Set



Nr.	A	B	M	D	L114
Nr.301	EP006H + A002	14	EP00M3, EP00M4, EP00M5, EP00M6, EP00M8, EP00M10, EP00M12	A0022.5, A0023.3, A0024.2, A0025.0, A0026.8, A0028.5, A00210.2	L114301
Nr.302	EX006H + A002	14	EX00M3, EX00M4, EX00M5, EX00M6, EX00M8, EX00M10, EX00M12	A0022.5, A0023.3, A0024.2, A0025.0, A0026.8, A0028.5, A00210.2	L114302
Nr.303	E297 + A002	14	E297M3, E297M4, E297M5, E297M6, E297M8, E297M10, E297M12	A0022.5, A0023.3, A0024.2, A0025.0, A0026.8, A0028.5, A00210.2	L114303 ³⁾⁴⁾
Nr.304	E298 + A002	14	E298M3, E298M4, E298M5, E298M6, E298M8, E298M10, E298M12	A0022.5, A0023.3, A0024.2, A0025.0, A0026.8, A0028.5, A00210.2	L114304 ³⁾⁴⁾
Nr.305	E238 + A108	14	E238M3, E238M4, E238M5, E238M6, E238M8, E238M10, E238M12	A1082.5, A1083.3, A1084.2, A1085.0, A1086.8, A1088.5, A10810.2	L114305 ³⁾⁵⁾
Nr.306	E240 + A108	14	E240M3, E240M4, E240M5, E240M6, E240M8, E240M10, E240M12	A1082.5, A1083.3, A1084.2, A1085.0, A1086.8, A1088.5, A10810.2	L114306 ³⁾⁵⁾

³⁾ 提供HSS-E, 直到新的可用库存 / Fornecido em HSS-E até disponibilidade do novo estoque /

Suministrado en HSS-E hasta disponibilidad de nuevo stock / Supplied in HSS-E until new stock available

⁴⁾ 黄圈鲨鱼丝锥 / Macho Máquina, Shark - Anel Amarelo / Machos Shark (Anillo Amarillo) / Yellow Shark Taps

⁵⁾ 蓝圈鲨鱼丝锥 / Macho Máquina, Shark - Anel Azul / Machos Shark (Anillo Azul) / Blue Shark Taps

L115

- 手用丝锥钻头套装
- Jogo de Broca + Macho Manual
- Juego de machos de mano y brocas
- Hand Tap-Drill Set

A= 套装形式, B=套装数量, M= 套装里的丝锥直径, D= 套装里的钻头直径

A=Tipos no jogo, B=No. no Jogo, M=Diâmetros de Machos no jogo, D= Diâmetros de Brocas no jogo

A = Tipos en el juego, B=No. en el Juego, M= Diámetros Machos en el Juego, D= Diámetros Brocas en el Juego

A= Styles in Set, B= No. in Set, M= Tap diameters in Set, D= Drill diameters in Set



Nr.	A	B	M	D	L115
Nr.100	E500 + A022	21	E500M3NO2, E500M3NO3, E500M4NO2, E500M4NO3, E500M5NO2, E500M5NO3, E500M6NO2, E500M6NO3, E500M8NO2, E500M8NO3, E500M10NO2, E500M10NO3, E500M12NO2, E500M12NO3	A0222.5, A0223.3, A0224.2, A0225.0, A0226.8, A0228.5, A02210.2	L115100
Nr.101	E500 + A002	14	E500M3NO3, E500M4NO3, E500M5NO3, E500M6NO3, E500M8NO3, E500M10NO3, E500M12NO3	A0022.5, A0023.3, A0024.2, A0025.0, A0026.8, A0028.5, A00210.2	L115101

L120

- 成套丝锥
- Estojo de Roscagem, Cx. Metálica
- Estojo de Roscagem, Cx. Metálica
- Threading Equipment Set

A= 套装形式, B= 套装里的数量, M= 套装里的丝锥直径, F= 套装模具直径, L111= 套装里丝锥扳手, L110= 套装模具库存

A=Tipos no jogo, B=No. no Jogo, M=Diâmetros de Machos no jogo, F= Diâmetros de Cossinetes no jogo, L111= Desandador Ajustável no jogo, L110= Desandador para Cossinites no jogo

A = Tipos en el juego, B=No. en el Juego, M= Diámetros Machos en el Juego, F= Diámetros Terrajas en el Juego, L111 - en el Juego, L110 - en el Juego

A= Styles in Set, B= No. in Set, M= Tap diameters in Set, F= Die diameters in Set, L111= Tap wrenches in Set, L110= Die stocks in Set



Nr.	A	B	M	F	L111	L110	L120
Nr.21	E100 + F100 + L111 + L110	21	E100M3NO8, E100M4NO8, E100M5NO8, E100M6NO8, E100M8NO8, E100M10NO8, E100M12NO8	F100M3, F100M4, F100M5, F100M6, F100M8, F100M10, F100M12	L111NO1, L111NO2	L1102A, L1102B, L1103, L1104, L1105	L12021
Nr.30	E100 + F100 + L111 + L110	30	E100M3NO8, E100M4NO8, E100M5NO8, E100M6NO8, E100M8NO8, E100M10NO8, E100M12NO8, E100M14NO8, E100M16NO8, E100M18NO8, E100M20NO8	F100M3, F100M4, F100M5, F100M6, F100M8, F100M10, F100M12, F100M14, F100M16, F100M18, F100M20	L111NO1, L111NO3	L1102A, L1102B, L1103, L1104, L1105, L1106	L12030
HS-2M	E500 + F300 + L111 + L110	23	E500M2NO1, E500M2NO3, E500M2.5NO1, E500M2.5NO3, E500M3NO1, E500M3NO3, E500M3.5NO1, E500M3.5NO3, E500M4NO1, E500M4NO3, E500M5NO1, E500M5NO3, E500M6NO1, E500M6NO3	F300M2X13/16, F300M2.5X13/16, F300M3X13/16, F300M3.5X13/16, F300M4X13/16, F300M5X13/16, F300M6X13/16	L111BT1	L11013/16	L1202M
HS-4M	E500 + F300 + L111 + L110	32	E500M5NO1, E500M5NO3, E500M6NO1, E500M6NO3, E500M7NO1, E500M7NO3, E500M8NO1, E500M8NO3, E500M9NO1, E500M9NO3, E500M10NO1, E500M10NO3, E500M11NO1, E500M11NO3, E500M12NO1, E500M12NO3	F300M5X13/16, F300M6X13/16, F300M7X13/16, F300M8X1.5/16, F300M9X1.5/16, F300M10X1.5/16, F300M11X1.5/16, F300M12X1.5/16, F300M5X13/16, F300M6X13/16, F300M7X13/16, F300M8X1.5/16, F300M9X1.5/16	L111BT2	L11013/16, L1101.5/16	L1204M

Nr.	A	B	M	F	L111	L110	L120
HS-8M	E500 + F300 + L111 + L110	17	E500M2NO1, E500M2NO3, E500M3NO1, E500M3NO3, E500M4NO1, E500M4NO3, E500M5NO1, E500M5NO3, E500M6NO1, E500M6NO3	F300M2X13/16, F300M3X13/16, F300M4X13/16, F300M5X13/16, F300M6X13/16	L111BT1	L11013/16	L1208M
HS-10M	E500 + F300 + L111 + L110	27	E500M3NO1, E500M3NO3, E500M4NO1, E500M4NO3, E500M5NO1, E500M5NO3, E500M6NO1, E500M6NO3, E500M7NO1, E500M7NO3, E500M8NO1, E500M8NO3, E500M9NO1, E500M9NO3, E500M10NO1, E500M10NO3	F300M3X13/16, F300M4X13/16, F300M5X13/16, F300M6X1, F300M7X1, F300M8X1, F300M9X1, F300M10X1	L111BT2	L11013/16, L1101INCH	L12010M
HS-12M	E500 + F300 + L111 + L110	35	E500M2NO1, E500M2NO3, E500M3NO1, E500M3NO3, E500M4NO1, E500M4NO3, E500M5NO1, E500M5NO3, E500M6NO1, E500M6NO3, E500M7NO1, E500M7NO3, E500M8NO1, E500M8NO3, E500M9NO1, E500M9NO3, E500M10NO1, E500M10NO3, E500M12NO1, E500M12NO3	F300M2X13/16, F300M3X13/16, F300M4X13/16, F300M5X13/16, F300M6X13/16, F300M7X13/16, F300M8X1, F300M9X1, F300M10X1, F300M12X1.5/16	L111BT1, L111BT2	L11013/16, L1101INCH, L1101.5/16	L12012M
HS-14M	E500 + F300 + L111 + L110	34	E500M6NO1, E500M6NO3, E500M7NO1, E500M7NO3, E500M8NO1, E500M8NO3, E500M9NO1, E500M9NO3, E500M10NO1, E500M10NO3, E500M12NO1, E500M12NO3, E500M14NO1, E500M14NO3, E500M16NO1, E500M16NO3, E500M18NO1, E500M18NO3, E500M20NO1, E500M20NO3	F300M6X1, F300M7X1, F300M8X1, F300M9X1, F300M10X1, F300M12X1.5/16, F300M14X1.5/16, F300M16X1.1/2, F300M18X1.1/2, F300M20X1.1/2	L111NO2	L1101INCH, L1101.5/16, L1101.1/2	L12014M
HS-30UNC	E515 + F320 + L111 + L110	18	E5151/2NO1, E5151/2NO3, E5151/4NO1, E5151/4NO3, E5155/16NO1, E5155/16NO3, E5153/8NO1, E5153/8NO3, E5157/16NO1, E5157/16NO3	F3201/4X1, F3205/16X1, F3207/16X1.5/16, F3203/8X1, F3201/2X1.5/16	L111BT2	L1101INCH, L1101.5/16	L12030UNC
HS-32UNC	E515 + F320 + L111 + L110	27	E5151/2NO1, E5151/2NO3, E5151/4NO1, E5151/4NO3, E5155/16NO1, E5155/16NO3, E5153/8NO1, E5153/8NO3, E5157/16NO1, E5157/16NO3, E5155/8NO1, E5155/8NO3, E5153/4NO1, E5153/4NO3	F3201/4X1, F3205/16X1, F3207/16X1.5/16, F3203/8X1, F3207/16X1.1/2, F3201/2X1.5/16, F3201/2X1.1/2, F3205/8X1.1/2, F3203/4X1.1/2	L111BT2, L111NO2	L1101INCH, L1101.1/2	L12032UNC
HS-24UNF	E524 + F330 + L111 + L110	18	E5241/2NO1, E5241/2NO3, E5241/4NO1, E5241/4NO3, E5245/16NO1, E5245/16NO3, E5243/8NO1, E5243/8NO3, E5247/16NO1, E5247/16NO3	F3301/4X1, F3305/16X1, F3307/16X1.5/16, F3303/8X1, F3301/2X1.5/16	L111BT2	L1101INCH, L1101.5/16	L12024UNF
HS-26UNF	E524 + F330 + L111 + L110	25	E5241/2NO1, E5241/2NO3, E5241/4NO1, E5241/4NO3, E5245/16NO1, E5245/16NO3, E5243/8NO1, E5243/8NO3, E5247/16NO1, E5247/16NO3, E5245/8NO1, E5245/8NO3, E5243/4NO1, E5243/4NO3	F3301/4X1, F3305/16X1, F3303/8X1, F3307/16X1.1/2, F3301/2X1.1/2, F3305/8X1.1/2, F3303/4X1.1/2	L111BT2, L111NO2	L1101INCH, L1101.1/2	L12026UNF

F100	317	F201	317
F108	317	F202	333
F110	319	F272	336
F120	321	F300	328
F130	322	F302	334
F140	323	F310	329
F150	324	F312	335
F170	325	F320	330
F180	326	F330	331
F190	327	F370	332



313 - 336



螺纹形式	Tipo de Rosca	Forma de Rosca	Thread form
标准	Norma	Estándar	Standard
公差	Tolerância	Tolerancia	Tolerance
倒锥	Chanfro	Chañlán	Chamfer
材料	Material	Material	Material
加工方向	Direção	Dirección	Direction
涂层	Tratamento	Tratamiento superficial	Coating
<ul style="list-style-type: none"> ■ 性能卓越 ■ 性能良好 实例 10 = 外缘处的切削速度，米/分， +/- 10%	Excelente para a Aplicação Bom para a Aplicação Exemplo 10 = Velocidade periférica em metros/minuto +/- 10%	Excelente para Aplicación Bueno para Aplicación Ejemplo 10 = Velocidad Periférica en metros/minuto +/- 10%	Excellent for Application Good for Application Example 10 = Peripheral speed in metres/minute +/- 10%
产品型号	Código	Código de producto	Product Codes
尺寸范围	Gama de medidas	Rango de Diámetros	Size Range

AMG	中文	Português	Español	English
1.1	铁磁性低碳钢	Aço macio magnético	Acero blando	Magnetic soft steel
1.2	结构钢, 表面渗碳钢	Aço estrutural, Aço cementado	Acero de construcción/cementación	Structural steel, case carburizing steel
1.3	普通碳钢	Aço-carbono	Acero al carbono	Plain Carbon steel
1.4	合金钢	Aço de liga	Acero aleado	Alloy steel
1.5	合金钢, 淬火回火钢	Aço de liga, Aço temperado	Acero aleado/temple y revenido	Alloy steel, Hardened and tempered steel
1.6	合金钢, 淬火回火钢	Aço de liga, Aço temperado	Acero aleado/temple y revenido	Alloy steel, Hardened and tempered steel
1.7	热处理合金钢	Aço de liga temperado	Acero aleado cementado	Alloy steel, Heat treated
1.8	淬火合金钢, 耐磨钢	Aço de liga temperado	Acero aleado cementado	Alloy steel, Hardened & Wear resistant steel
2.1	易切削不锈钢	Aço inoxidável de maquinagem fácil	Acero inoxidable fácil mecanizado	Free machining, Stainless Steel
2.2	奥氏体不锈钢	Austenítico	Austenítico	Austenitic
2.3	铁素体 + 奥氏体, 马氏体不锈钢	Ferrítico + Austenítico + Martensítico	Ferrítico, Ferr. + Aust., Marten	Ferritic + Austenitic, Ferritic, Martensitic
2.4	沉淀硬化不锈钢	Aço inoxidável de fácil usinagem	Acero Inoxidable Templado	Precipitation Hardened
3.1	灰铸铁	Grafite laminar	Con grafito laminar	Lamellar graphite
3.2	灰铸铁	Grafite laminar	Con grafito laminar	Lamellar graphite
3.3	球墨铸铁, 可锻铸铁	Grafite nodular/ Ferro fundido maleável	Con graf. laminar, fundic. maleable	Nodular graphite, Malleable Cast Iron
3.4	球墨铸铁, 可锻铸铁	Grafite nodular/ Ferro fundido maleável	Con graf. laminar, fundic. maleable	Nodular graphite, Malleable Cast Iron
4.1	纯钛	Titânio, sem liga	Titanio no aleado	Titanium, unalloyed
4.2	钛合金	Titânio, com liga	Titanio aleado	Titanium, alloyed
4.3	钛合金	Titânio, com liga	Titanio aleado	Titanium, alloyed
5.1	纯镍	Níquel, sem liga	Níquel no aleado	Nickel, unalloyed
5.2	镍合金	Níquel, com liga	Níquel aleado	Nickel, alloyed
5.3	镍合金	Níquel, com liga	Níquel aleado	Nickel, alloyed
6.1	紫铜	Cobre	Cobre	Copper
6.2	β黄铜, 青铜	Latão beta, bronze	β-Latón, bronce	β-Brass, Bronze
6.3	α黄铜	Latão alfa	α-Latón	α-Brass
6.4	高强度青铜	Bronze de alta resistência	Metal AMPCO	High Strength Bronze
7.1	纯铝, 纯镁	Al, Mg, sem liga	Al, Mg, no aleado	Al, Mg, unalloyed
7.2	铝合金, 硅含量 < 0.5%	Al com liga, Si<0.5%	Al aleado con Si < 0.5%	Al alloyed, Si < 0.5%
7.3	铝合金, 硅含量 > 0.5% < 10%	Al com liga, Si>0.5%<10%	Al aleado con Si > 0.5% < 10%	Al alloyed, Si > 0.5% < 10%
7.4	铝合金, 硅含量 > 10% 晶须增强铝合金, 镁合金	Al com liga, Si>10% reforçadas com monocristais filiformes, ligas de Al/Mg	Al aleado, Si>10% Reforzado por filamentos, Al-aleados, Mg-aleados	Al alloyed, Si > 10% Whisker reinforced Al-alloys Mg-alloys
8.1	热塑性塑料	Termoplásticos	Termoplásticos	Thermoplastics
8.2	热固性塑料	Plásticos termoduros	Plásticos endurecidos por calor	Thermosetting plastics
8.3	增强塑料	Materiais plásticos reforçados	Materiales plásticos reforzados	Reinforced plastic materials
9.1	金属陶瓷	Cerametal (metalocerâmica)	Cerametales (metales-cerâmicas)	Cermets (metals-ceramics)
10.1	标准石墨	Grafite standard	Grafito standard	Graphite

M	M	M	MF	UNC	UNF	BSW	BSF	G	NPT	PG
ISO 2568	ISO 2568	ISO 2568	ISO 2568	ISO 2568	ISO 2568	ISO 2568	ISO 2568	ISO 2568	ISO 2568	ISO 2568
6g	6g	6g	6g	2A	2A	Medium	Medium	Class A	Normal	Normal
1.75XP	1.75XP	2.25XP	1.75XP	1.75XP	1.75XP	1.75XP	1.75XP	1.75XP	1.75XP	1.75XP
HSS	HSS	HSS-E	HSS	HSS	HSS	HSS	HSS	HSS	HSS	HSS



F100	F201	F108	F110	F120	F130	F140	F150	F170	F180	F190
M2 - M42	M3 - M20	M2 - M20	M4 - M40	No.8 - 1"	No.10 - 1"	1/8 - 1"	3/16 - 1/2	1/8 - 2"	1/8 - 1"	PG7 - PG36

AMG	317	317	317	319	321	322	323	324	325	326	327	ISO
1.1	■8	■8	■8	■8	■8	■8	■8	■8	■8	■8	■8	P 1
1.2	■7	■7	■7	■7	■7	■7	■7	■7	■7	■7	■7	P 1
1.3	■6	■6	■6	■6	■6	■6	■6	■6	■6	■6	■6	P 2
1.4	■5	■5	■5	■5	■5	■5	■5	■5	■5	■5	■5	P 3
1.5			■4									P 4
1.6												H 1
1.7												H 3
1.8												H 4
2.1	■4	■4	■4	■4	■4	■4	■4	■4	■4	■4	■4	M 1
2.2	■2	■2	■2	■2	■2	■2	■2	■2	■2	■2	■2	M 3
2.3			■1									M 2
2.4												S 2
3.1	■8	■8	■8	■8	■8	■8	■8	■8	■8	■8	■8	K 1
3.2	■7	■7	■7	■7	■7	■7	■7	■7	■7	■7	■7	K 2
3.3	■6	■6	■6	■6	■6	■6	■6	■6	■6	■6	■6	K 3
3.4	■5	■5	■5	■5	■5	■5	■5	■5	■5	■5	■5	K 4
4.1			■2									S 1
4.2												S 2
4.3	■2	■2	■2	■2	■2	■2	■2	■2	■2	■2	■2	S 3
5.1	■9	■9	■9	■9	■9	■9	■9	■9	■9	■9	■9	S 1
5.2	■2	■2	■2	■2	■2	■2	■2	■2	■2	■2	■2	S 2
5.3	■2	■2	■2	■2	■2	■2	■2	■2	■2	■2	■2	S 3
6.1	■9	■9	■9	■9	■9	■9	■9	■9	■9	■9	■9	N 3
6.2	■8	■8	■8	■8	■8	■8	■8	■8	■8	■8	■8	N 4
6.3	■7	■7	■7	■7	■7	■7	■7	■7	■7	■7	■7	N 3
6.4			■2									N 4
7.1	■10	■10	■10	■10	■10	■10	■10	■10	■10	■10	■10	N 1
7.2	■15	■15	■15	■15	■15	■15	■15	■15	■15	■15	■15	N 1
7.3	■15	■15	■15	■15	■15	■15	■15	■15	■15	■15	■15	N 1
7.4	■10	■10	■10	■10	■10	■10	■10	■10	■10	■10	■10	N 2
8.1	■15	■15	■15	■15	■15	■15	■15	■15	■15	■15	■15	O
8.2	■10	■10	■10	■10	■10	■10	■10	■10	■10	■10	■10	O
8.3	■5	■5	■5	■5	■5	■5	■5	■5	■5	■5	■5	O
9.1												H
10.1												O

M	MF	UNC	UNF	G	M	M	MF	G
BS 1127: 1950	BS 1127: 1950	BS 1127: 1950	BS 1127: 1950	BS 1127: 1950	DIN 382	BS 1127: 1950	BS 1127: 1950	DIN 382
					6g	6g	6g	Class A
1.75XP	1.75XP	1.75XP	1.75XP	1.75XP	1.75XP	1.75XP	1.75XP	1.75XP
HSS	HSS	HSS	HSS	HSS	HSS	HSS	HSS	HSS



F300	F310	F320	F330	F370	F202	F302	F312	F272
M2 - M36	M3 - M30	No.4 - 1.1/4	No.4 - 1.1/2	1/8 - 1.1/2	M3 - M36	M3 - M36	M8 - M24	1/8 - 1.1/2

AMG	328	329	330	331	332	333	334	335	336	ISO
1.1	■8	■8	■8	■8	■8	■8	■8	■8	■8	P 1
1.2	■7	■7	■7	■7	■7	■7	■7	■7	■7	P 1
1.3	■6	■6	■6	■6	■6	■6	■6	■6	■6	P 2
1.4	■5	■5	■5	■5	■5	■5	■5	■5	■5	P 3
1.5										P 4
1.6										H 1
1.7										H 3
1.8										H 4
2.1	■4	■4	■4	■4	■4	■4	■4	■4	■4	M 1
2.2	■2	■2	■2	■2	■2	■2	■2	■2	■2	M 3
2.3										M 2
2.4										S 2
3.1	■8	■8	■8	■8	■8	■8	■8	■8	■8	K 1
3.2	■7	■7	■7	■7	■7	■7	■7	■7	■7	K 2
3.3	■6	■6	■6	■6	■6	■6	■6	■6	■6	K 3
3.4	■5	■5	■5	■5	■5	■5	■5	■5	■5	K 4
4.1										S 1
4.2										S 2
4.3	■2	■2	■2	■2	■2	■2	■2	■2	■2	S 3
5.1	■9	■9	■9	■9	■9	■9	■9	■9	■9	S 1
5.2	■2	■2	■2	■2	■2	■2	■2	■2	■2	S 2
5.3	■2	■2	■2	■2	■2	■2	■2	■2	■2	S 3
6.1	■9	■9	■9	■9	■9	■9	■9	■9	■9	N 3
6.2	■8	■8	■8	■8	■8	■8	■8	■8	■8	N 4
6.3	■7	■7	■7	■7	■7	■7	■7	■7	■7	N 3
6.4										N 4
7.1	■10	■10	■10	■10	■10	■10	■10	■10	■10	N 1
7.2	■15	■15	■15	■15	■15	■15	■15	■15	■15	N 1
7.3	■15	■15	■15	■15	■15	■15	■15	■15	■15	N 1
7.4	■10	■10	■10	■10	■10	■10	■10	■10	■10	N 2
8.1	■15	■15	■15	■15	■15	■15	■15	■15	■15	O
8.2	■10	■10	■10	■10	■10	■10	■10	■10	■10	O
8.3	■5	■5	■5	■5	■5	■5	■5	■5	■5	O
9.1										H
10.1										O

F100	M	ISO 2568	6g	1.75XP	HSS		
F201	M	ISO 2568	6g	1.75XP	HSS		
F108	M	ISO 2568	6g	2.25XP	HSS-E		



- F100** • M 带刃倾角板牙
- F201** • M Cossinete
- F108** • M Terrajas de roscar
- F108** • M Gun Nosed Die

F100; F201	▪	1.1	1.2	1.3	3.1	3.2	3.3	7.1	7.2	7.3								
	•	1.4	2.1	2.2	3.4	4.3	5.1	5.2	5.3	6.1	6.2	6.3	7.4	8.1	8.2	8.3		
F108	▪	1.3	1.4	2.1	2.2	3.1	3.2	3.3	7.1	7.2	7.3							
	•	1.1	1.2	1.5	2.3	3.4	4.1	4.3	5.1	5.2	5.3	6.1	6.2	6.3	6.4	7.4	8.1	8.2

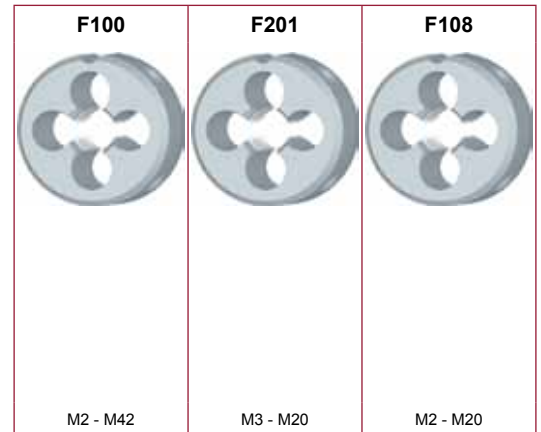
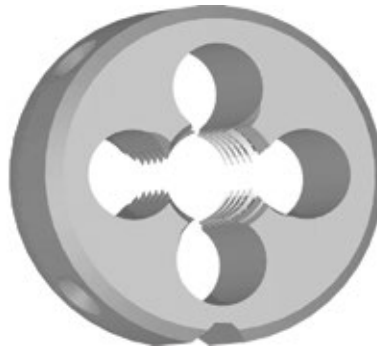
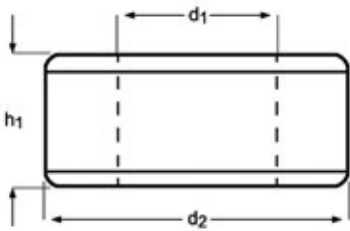

M	P mm	d ₂ Ø mm	h ₁ mm	F100	F201	F108
2	0.40	16	5	F100M2		F108M2
2.5	0.45	16	5	F100M2.5		F108M2.5
2.6	0.45	16	5	F100M2.6		
3	0.50	20	5	F100M3	F201M3	F108M3
3.5	0.60	20	5	F100M3.5		
4	0.70	20	5	F100M4	F201M4	F108M4
4.5	0.75	20	7	F100M4.5		
5	0.80	20	7	F100M5	F201M5	F108M5
6	1.00	20	7	F100M6	F201M6	F108M6
7	1.00	25	9	F100M7		
8	1.25	25	9	F100M8	F201M8	F108M8
9	1.25	25	9	F100M9		
10	1.50	30	11	F100M10	F201M10	F108M10
11	1.50	30	11	F100M11		
12	1.75	38	14	F100M12	F201M12	F108M12
14	2.00	38	14	F100M14	F201M14	F108M14
16	2.00	45	18	F100M16	F201M16	F108M16
18	2.50	45	18	F100M18	F201M18	F108M18
20	2.50	45	18	F100M20	F201M20	F108M20
22	2.50	55	22	F100M22		
24	3.00	55	22	F100M24		
27	3.00	65	25	F100M27		
30	3.50	65	25	F100M30		

¹⁾ 不带刃倾角 / Sem ponta helicoidal / Sin entrada en hélice / Without gun-nose

M	P mm	d₂ ∅ mm	h₁ mm	F100	F201	F108
33	3.50	65	25	F100M33		
36	4.00	65	25	F100M36		
39	4.00	75	30	F100M39		
42	4.50	75	30	F100M42		

F110



- MF 带刃倾角板牙
- MF Cossinete
- MF Terrajas de roscar
- MF Gun Nosed Die

F110

F110	▪	1.1	1.2	1.3	3.1	3.2	3.3	7.1	7.2	7.3						
	•	1.4	2.1	2.2	3.4	4.3	5.1	5.2	5.3	6.1	6.2	6.3	7.4	8.1	8.2	8.3

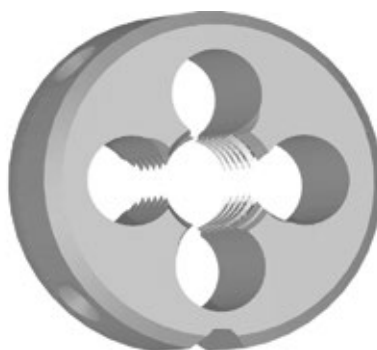
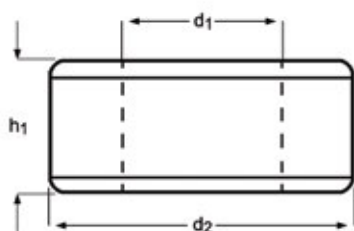

MF	P mm	d ₂ Ø mm	h ₁ mm	F110
4	0.50	20	5	F110M4X.5
5	0.50	20	5	F110M5X.5
6	0.75	20	7	F110M6X.75
7	0.75	25	9	F110M7X.75
8	0.75	25	9	F110M8X.75
8	1.00	25	9	F110M8X1.0
9	1.00	25	9	F110M9X1.0
10	0.75	30	11	F110M10X.75
10	1.00	30	11	F110M10X1.0
10	1.25	30	11	F110M10X1.25
11	1.00	30	11	F110M11X1.0
12	1.00	38	10	F110M12X1.0
12	1.25	38	10	F110M12X1.25
12	1.50	38	10	F110M12X1.5
13	1.00	38	10	F110M13X1.0
14	1.00	38	10	F110M14X1.0
14	1.25	38	10	F110M14X1.25
14	1.50	38	10	F110M14X1.5
15	1.00	38	10	F110M15X1.0
15	1.50	38	10	F110M15X1.5
16	1.00	45	14	F110M16X1.0
16	1.50	45	14	F110M16X1.5
18	1.00	45	14	F110M18X1.0
18	1.50	45	14	F110M18X1.5
20	1.00	45	14	F110M20X1.0
20	1.50	45	14	F110M20X1.5
22	1.00	55	16	F110M22X1.0
22	1.50	55	16	F110M22X1.5
24	1.00	55	16	F110M24X1.0
24	1.50	55	16	F110M24X1.5
24	2.00	55	16	F110M24X2.0
25	1.50	55	16	F110M25X1.5
26	1.50	55	16	F110M26X1.5
27	1.50	65	18	F110M27X1.5
27	2.00	65	18	F110M27X2.0
28	1.50	65	18	F110M28X1.5

MF	P mm	d₂ Ø mm	h₁ mm	F110
30	1.50	65	18	F110M30X1.5
32	1.50	65	18	F110M32X1.5
35	1.50	65	18	F110M35X1.5
36	1.50	65	18	F110M36X1.5
40	1.50	75	20	F110M40X1.5

F120

UNC

ISO
2568

2A

1.75XP

HSS



- UNC 带刃倾角板牙
- UNC Cossinete
- UNC Terrajas de roscar
- UNC Gun Nosed Die

F120

F120	▪	1.1	1.2	1.3	3.1	3.2	3.3	7.1	7.2	7.3								
	•	1.4	2.1	2.2	3.4	4.3	5.1	5.2	5.3	6.1	6.2	6.3	7.4	8.1	8.2	8.3		

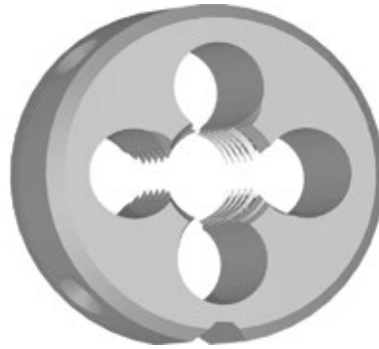
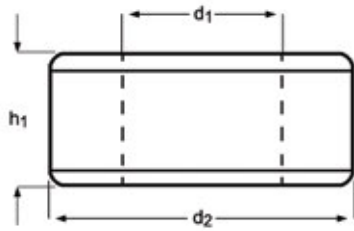

UNC	TPI	d ₁ nom mm	d ₂ Ø mm	h ₁ mm	F120
8	32	4.17	20	7	F1208-32
10	24	4.83	20	7	F12010-24
1/4	20	6.35	20	7	F1201/4
5/16	18	7.94	25	9	F1205/16
3/8	16	9.53	30	11	F1203/8
7/16	14	11.11	30	11	F1207/16
1/2	13	12.70	38	14	F1201/2
9/16	12	14.29	38	14	F1209/16
5/8	11	15.88	45	18	F1205/8
3/4	10	19.05	45	18	F1203/4
7/8	9	22.23	55	22	F1207/8
1"	8	25.40	55	22	F1201

F130



- UNF 带刃倾角板牙
- UNF Cossinete
- UNF Terrajas de roscar
- UNF Gun Nosed Die

F130

F130	▪	1.1	1.2	1.3	3.1	3.2	3.3	7.1	7.2	7.3					
	•	1.4	2.1	2.2	3.4	4.3	5.1	5.2	5.3	6.1	6.2	6.3	7.4	8.1	8.2

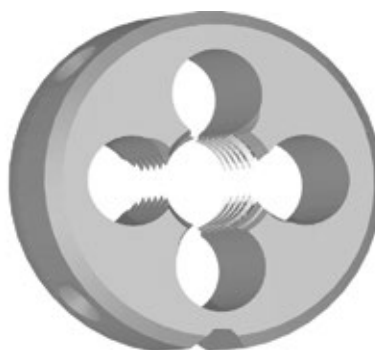
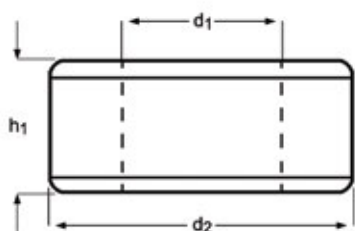

UNF	TPI	d ₁ nom mm	d ₂ Ø mm	h ₁ mm	F130
10	32	4.83	20	7	F13010-32
1/4	28	6.35	20	7	F1301/4
5/16	24	7.94	25	9	F1305/16
3/8	24	9.53	30	11	F1303/8
7/16	20	11.11	30	11	F1307/16
1/2	20	12.70	38	10	F1301/2
9/16	18	14.29	38	10	F1309/16
5/8	18	15.88	45	14	F1305/8
3/4	16	19.05	45	14	F1303/4
7/8	14	22.23	55	16	F1307/8
1"	12	25.40	55	16	F1301

F140

BSW

ISO
2568

Medium

1.75XP

HSS



- BSW 带刃倾角板牙
- BSW Cossinete
- BSW Terrajas de roscar
- BSW Gun Nosed Die

F140

F140	▪	1.1	1.2	1.3	3.1	3.2	3.3	7.1	7.2	7.3						
	•	1.4	2.1	2.2	3.4	4.3	5.1	5.2	5.3	6.1	6.2	6.3	7.4	8.1	8.2	8.3

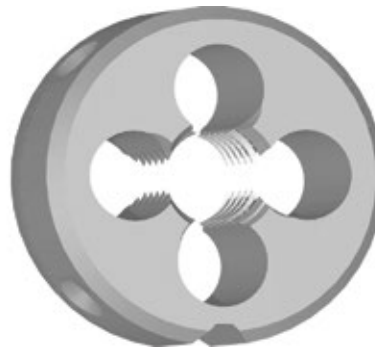
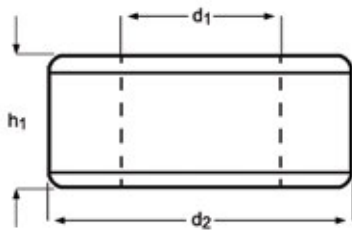

BSW	TPI	d_1 nom mm	d_2 \varnothing mm	h_1 mm	F140
1/8	40	3.17	20	5	F1401/8
3/16	24	4.76	20	7	F1403/16
1/4	20	6.35	20	7	F1401/4
5/16	18	7.94	25	9	F1405/16
3/8	16	9.53	30	11	F1403/8
7/16	14	11.11	30	11	F1407/16
1/2	12	12.70	38	14	F1401/2
5/8	11	15.88	45	18	F1405/8
3/4	10	19.05	45	18	F1403/4
7/8	9	22.23	55	22	F1407/8
1"	8	25.40	55	22	F1401

F150

BSF

ISO
2568

Medium

1.75XP

HSS



- BSF 带刃倾角板牙
- BSF Cossinete
- BSF Terrajas de roscar
- BSF Gun Nosed Die

F150

F150	▪	1.1	1.2	1.3	3.1	3.2	3.3	7.1	7.2	7.3							
	•	1.4	2.1	2.2	3.4	4.3	5.1	5.2	5.3	6.1	6.2	6.3	7.4	8.1	8.2	8.3	

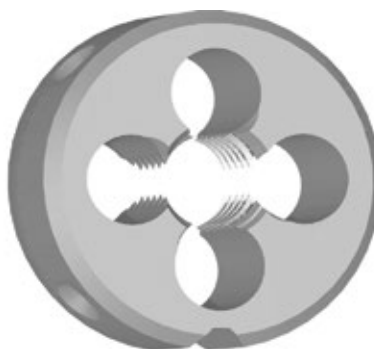
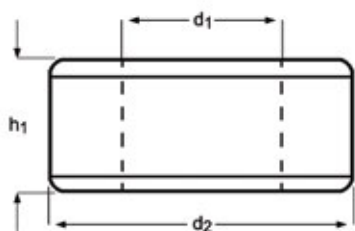

BSF	TPI	d_1 nom mm	d_2 \emptyset mm	h_1 mm	F150
3/16	32	4.76	20	7	F1503/16
1/4	26	6.35	20	7	F1501/4
5/16	22	7.94	25	9	F1505/16
3/8	20	9.53	30	11	F1503/8
7/16	18	11.11	30	11	F1507/16
1/2	16	12.70	38	10	F1501/2

F170



- G(BSP) 带刃倾角板牙
- G(BSP) Cossinete
- G(BSP) Terrajas de roscar
- G(BSP) Gun Nosed Die

F170

F170	▪	1.1	1.2	1.3	3.1	3.2	3.3	7.1	7.2	7.3								
	•	1.4	2.1	2.2	3.4	4.3	5.1	5.2	5.3	6.1	6.2	6.3	7.4	8.1	8.2	8.3		

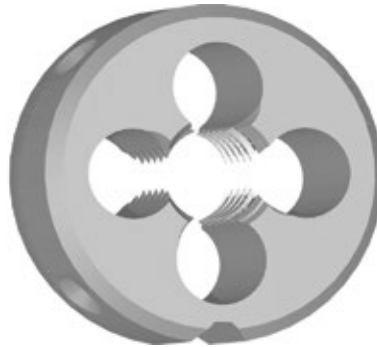
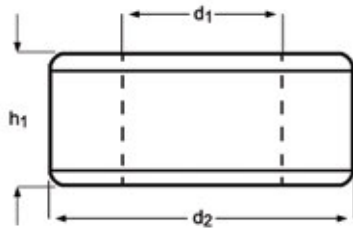

G(BSP)	TPI	d ₁ nom mm	d ₂ Ø mm	h ₁ mm	F170
1/8	28	9.73	30	11	F1701/8
1/4	19	13.16	38	10	F1701/4
3/8	19	16.66	45	14	F1703/8
1/2	14	20.96	45	14	F1701/2
5/8	14	22.91	55	16	F1705/8
3/4	14	26.44	55	16	F1703/4
7/8	14	30.20	65	18	F1707/8
1"	11	33.25	65	18	F1701
1.1/8	11	37.89	75	20	F1701.1/8
1.1/4	11	41.91	75	20	F1701.1/4
1.1/2	11	47.80	90	22	F1701.1/2
2"	11	59.61	105	22	F1702

F180



- NPT 带刃倾角板牙
- NPT Cossinete
- NPT Terrajas de roscar
- NPT Gun Nosed Die

F180

F180	▪	1.1	1.2	1.3	3.1	3.2	3.3	7.1	7.2	7.3						
	•	1.4	2.1	2.2	3.4	4.3	5.1	5.2	5.3	6.1	6.2	6.3	7.4	8.1	8.2	8.3

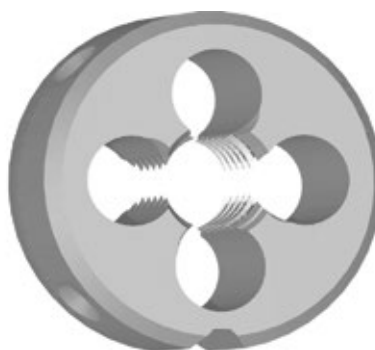
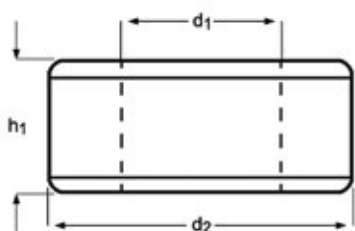

NPT	TPI	d_1 nom mm	d_2 \varnothing mm	h_1 mm	F180
1/8	27	9.49	30	11	F1801/8
1/4	18	12.49	38	14	F1801/4
3/8	18	15.93	45	14	F1803/8
1/2	14	19.77	45	18	F1801/2
3/4	14	25.12	55	22	F1803/4
1"	11.5	31.46	65	25	F1801

F190



- PG 带刃倾角板牙
- PG Cossinete
- PG Terrajas de roscar
- PG Gun Nosed Die

F190

F190	▪	1.1	1.2	1.3	3.1	3.2	3.3	7.1	7.2	7.3							
	•	1.4	2.1	2.2	3.4	4.3	5.1	5.2	5.3	6.1	6.2	6.3	7.4	8.1	8.2	8.3	

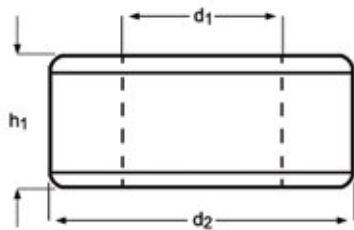

PG	TPI	d ₁ nom mm	d ₂ Ø mm	h ₁ mm	F190
7	20	12.5	38	10	F190PG7
9	18	15.2	38	10	F190PG9
11	18	18.6	45	14	F190PG11
13.5	18	20.4	45	14	F190PG13.5
16	18	22.5	55	16	F190PG16
21	16	28.3	65	18	F190PG21
29	16	37.0	65	18	F190PG29
36	16	47.0	90	22	F190PG36

F300



- M 可调节板牙
- M Cossinetes ajustáveis
- M Terraja tipo abierto
- M Adjustable Dies

F300

F300	▪	1.1	1.2	1.3	3.1	3.2	3.3	7.1	7.2	7.3							
	•	1.4	2.1	2.2	3.4	4.3	5.1	5.2	5.3	6.1	6.2	6.3	7.4	8.1	8.2	8.3	

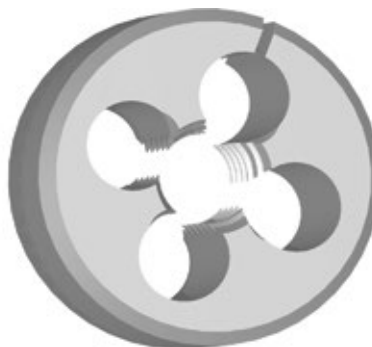
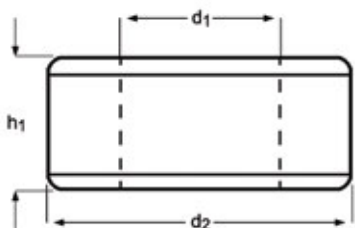

M	P mm	d ₂ Ø Inch	h ₁ Inch	F300
2	0.40	13/16	1/4	F300M2X13/16
2.5	0.45	13/16	1/4	F300M2.5X13/16
3	0.50	13/16	1/4	F300M3X13/16
3.5	0.60	13/16	1/4	F300M3.5X13/16
4	0.70	13/16	1/4	F300M4X13/16
5	0.80	13/16	1/4	F300M5X13/16
5	0.80	1"	3/8	F300M5X1
6	1.00	13/16	1/4	F300M6X13/16
6	1.00	1"	3/8	F300M6X1
6	1.00	1.5/16	7/16	F300M6X1.5/16
7	1.00	13/16	1/4	F300M7X13/16
7	1.00	1"	3/8	F300M7X1
8	1.25	1"	3/8	F300M8X1
8	1.25	1.5/16	7/16	F300M8X1.5/16
9	1.25	1"	3/8	F300M9X1
9	1.25	1.5/16	7/16	F300M9X1.5/16
10	1.50	1"	3/8	F300M10X1
10	1.50	1.5/16	7/16	F300M10X1.5/16
10	1.50	1.1/2	1/2	F300M10X1.1/2
11	1.50	1.5/16	7/16	F300M11X1.5/16
12	1.75	1.5/16	7/16	F300M12X1.5/16
12	1.75	1.1/2	1/2	F300M12X1.1/2
14	2.00	1.5/16	7/16	F300M14X1.5/16
14	2.00	1.1/2	1/2	F300M14X1.1/2
16	2.00	1.1/2	1/2	F300M16X1.1/2
16	2.00	2"	5/8	F300M16X2
18	2.50	1.1/2	1/2	F300M18X1.1/2
18	2.50	2"	5/8	F300M18X2
20	2.50	1.1/2	1/2	F300M20X1.1/2
20	2.50	2"	5/8	F300M20X2
22	2.50	2"	5/8	F300M22X2
24	3.00	2"	5/8	F300M24X2
27	3.00	3"	7/8	F300M27X3
30	3.50	3"	7/8	F300M30X3
36	4.00	3"	7/8	F300M36X3

F310

MF

BS
1127:
1950

1.75XP

HSS



- MF 可调节板牙
- MF Cossinetes ajustáveis
- MF Terraja tipo abierto
- MF Adjustable Dies

F310

F310	▪	1.1	1.2	1.3	3.1	3.2	3.3	7.1	7.2	7.3								
	•	1.4	2.1	2.2	3.4	4.3	5.1	5.2	5.3	6.1	6.2	6.3	7.4	8.1	8.2	8.3		

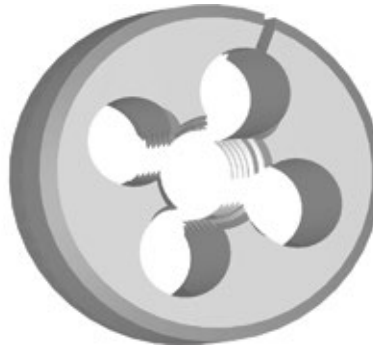
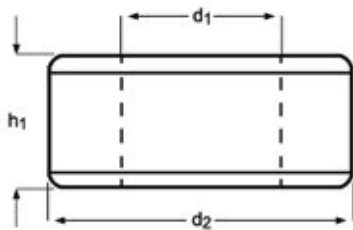

MF	P mm	d ₂ Ø Inch	h ₁ Inch	F310
3	0.35	13/16	1/4	F310M3X.35X13/16
4	0.50	13/16	1/4	F310M4X.5X13/16
4	0.75	13/16	1/4	F310M4X.75X13/16
5	0.50	13/16	1/4	F310M5X.5X13/16
5	0.90	13/16	1/4	F310M5X.9X13/16
6	0.75	13/16	1/4	F310M6X.75X13/16
8	0.75	1"	3/8	F310M8X.75X1
8	1.00	1"	3/8	F310M8X1.0X1
9	1.00	1"	3/8	F310M9X1.0X1
10	0.75	1"	3/8	F310M10X.75X1
10	1.00	1"	3/8	F310M10X1.0X1
10	1.25	1"	3/8	F310M10X1.25X1
10	1.25	1.5/16	7/16	F310M10X1.25X1.5/16
12	1.00	1.5/16	7/16	F310M12X1.0X1.5/16
12	1.25	1.5/16	7/16	F310M12X1.25X1.5/16
12	1.50	1.5/16	7/16	F310M12X1.5X1.5/16
14	1.25	1.5/16	7/16	F310M14X1.25X1.5/16
14	1.50	1.5/16	7/16	F310M14X1.5X1.5/16
16	1.00	1.1/2	1/2	F310M16X1.0X1.1/2
16	1.50	1.1/2	1/2	F310M16X1.5X1.1/2
18	1.50	1.1/2	1/2	F310M18X1.5X1.1/2
20	1.00	1.1/2	1/2	F310M20X1.0X1.1/2
20	1.50	2"	5/8	F310M20X1.5X2
20	2.00	1.1/2	1/2	F310M20X2.0X1.1/2
22	1.50	2"	5/8	F310M22X1.5X2
24	1.50	2"	5/8	F310M24X1.5X2
24	2.00	2"	5/8	F310M24X2.0X2
25	1.50	2"	5/8	F310M25X1.5X2
27	2.00	2.1/4	11/16	F310M27X2.0X2.1/4
30	2.00	2.1/4	11/16	F310M30X2.0X2.1/4

F320

UNC

BS
1127:
1950

1.75XP

HSS



L120
309

- UNC 可调节板牙
- UNC Cossinetes ajustáveis
- UNC Terraja tipo abierto
- UNC Adjustable Dies

F320

F320	▪	1.1	1.2	1.3	3.1	3.2	3.3	7.1	7.2	7.3						
	•	1.4	2.1	2.2	3.4	4.3	5.1	5.2	5.3	6.1	6.2	6.3	7.4	8.1	8.2	8.3

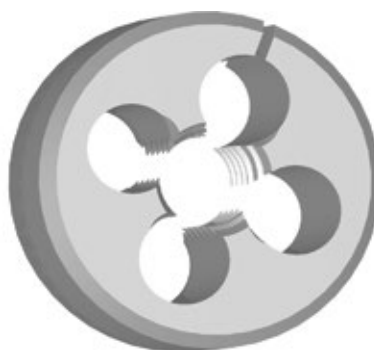
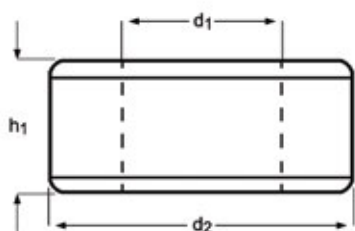

UNC	TPI	d_1 nom mm	d_2 \varnothing Inch	h_1 Inch	F320
4	40	2.85	13/16	1/4	F3204-40X13/16
5	40	3.18	13/16	1/4	F3205-40X13/16
6	32	3.51	13/16	1/4	F3206-32X13/16
8	32	4.17	13/16	1/4	F3208-32X13/16
8	32	4.17	1"	3/8	F3208-32X1
10	24	4.83	13/16	1/4	F32010-24X13/16
10	24	4.83	1"	3/8	F32010-24X1
12	24	5.49	13/16	1/4	F32012-24X13/16
1/4	20	6.35	13/16	1/4	F3201/4X13/16
1/4	20	6.35	1"	3/8	F3201/4X1
1/4	20	6.35	1.5/16	7/16	F3201/4X1.5/16
1/4	20	6.35	1.1/2	1/2	F3201/4X1.1/2
5/16	18	7.94	1"	3/8	F3205/16X1
5/16	18	7.94	1.1/2	1/2	F3205/16X1.1/2
3/8	16	9.53	1"	3/8	F3203/8X1
3/8	16	9.53	1.5/16	7/16	F3203/8X1.5/16
3/8	16	9.53	1.1/2	1/2	F3203/8X1.1/2
7/16	14	11.11	1.5/16	7/16	F3207/16X1.5/16
7/16	14	11.11	1.1/2	1/2	F3207/16X1.1/2
1/2	13	12.70	1.5/16	7/16	F3201/2X1.5/16
1/2	13	12.70	1.1/2	1/2	F3201/2X1.1/2
1/2	13	12.70	2"	5/8	F3201/2X2
9/16	12	14.29	1.1/2	1/2	F3209/16X1.1/2
5/8	11	15.88	1.1/2	1/2	F3205/8X1.1/2
5/8	11	15.88	2"	5/8	F3205/8X2
3/4	10	19.05	1.1/2	1/2	F3203/4X1.1/2
3/4	10	19.05	2"	5/8	F3203/4X2
7/8	9	22.23	2"	5/8	F3207/8X2
1"	8	25.40	2"	5/8	F3201X2
1.1/8	7	28.58	3"	7/8	F3201.1/8X3
1.1/4	7	31.75	3"	7/8	F3201.1/4X3

F330

UNF

BS
1127:
1950

1.75XP

HSS



L120
309

- UNF 可调节板牙
- UNF Cossinetes ajustáveis
- UNF Terraja tipo abierto
- UNF Adjustable Dies

F330

F330	▪	1.1	1.2	1.3	3.1	3.2	3.3	7.1	7.2	7.3								
	•	1.4	2.1	2.2	3.4	4.3	5.1	5.2	5.3	6.1	6.2	6.3	7.4	8.1	8.2	8.3		

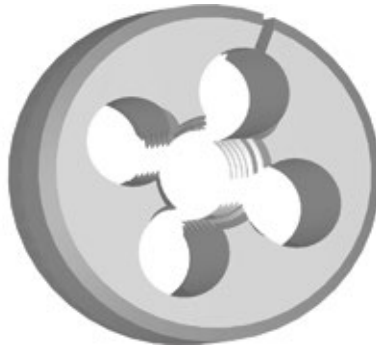
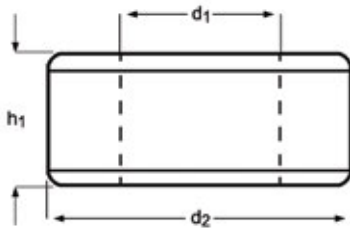

UNF	TPI	d ₁ nom mm	d ₂ Ø Inch	h ₁ Inch	F330
4	48	2.85	13/16	1/4	F3304-48X13/16
5	44	3.18	13/16	1/4	F3305-44X13/16
6	40	3.51	13/16	1/4	F3306-40X13/16
8	36	4.17	13/16	1/4	F3308-36X13/16
10	32	4.83	13/16	1/4	F33010-32X13/16
10	32	4.83	1"	3/8	F33010-32X1
12	28	5.49	13/16	1/4	F33012-28X13/16
1/4	28	6.35	13/16	1/4	F3301/4X13/16
1/4	28	6.35	1"	3/8	F3301/4X1
1/4	28	6.35	1.1/2	1/2	F3301/4X1.1/2
5/16	24	7.94	1"	3/8	F3305/16X1
5/16	24	7.94	1.5/16	7/16	F3305/16X1.5/16
5/16	24	7.94	1.1/2	1/2	F3305/16X1.1/2
3/8	24	9.53	1"	3/8	F3303/8X1
3/8	24	9.53	1.5/16	7/16	F3303/8X1.5/16
3/8	24	9.53	1.1/2	1/2	F3303/8X1.1/2
7/16	20	11.11	1"	3/8	F3307/16X1
7/16	20	11.11	1.5/16	7/16	F3307/16X1.5/16
7/16	20	11.11	1.1/2	1/2	F3307/16X1.1/2
1/2	20	12.70	1.5/16	7/16	F3301/2X1.5/16
1/2	20	12.70	1.1/2	1/2	F3301/2X1.1/2
9/16	18	14.29	1.5/16	7/16	F3309/16X1.5/16
9/16	18	14.29	1.1/2	1/2	F3309/16X1.1/2
5/8	18	15.88	1.1/2	1/2	F3305/8X1.1/2
5/8	18	15.88	2"	5/8	F3305/8X2
3/4	16	19.05	1.1/2	1/2	F3303/4X1.1/2
3/4	16	19.05	2"	5/8	F3303/4X2
7/8	14	22.23	2"	5/8	F3307/8X2
1"	12	25.40	2"	5/8	F3301X2
1.1/8	12	28.58	3"	7/8	F3301.1/8X3
1.1/4	12	31.75	3"	7/8	F3301.1/4X3
1.1/2	12	38.10	3"	7/8	F3301.1/2X3

F370



- G(BSP) 可调节板牙
- G(BSP) Cossinetes ajustáveis
- G(BSP) Terraaja tipo abierto
- G(BSP) Adjustable Dies

F370

F370	▪	1.1	1.2	1.3	3.1	3.2	3.3	7.1	7.2	7.3					
	•	1.4	2.1	2.2	3.4	4.3	5.1	5.2	5.3	6.1	6.2	6.3	7.4	8.1	8.2

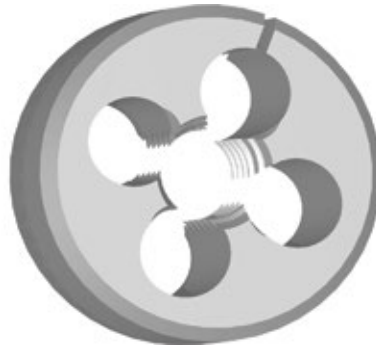
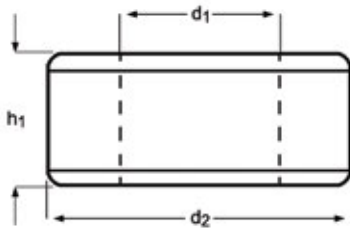

G(BSP)	TPI	d ₁ nom mm	d ₂ Ø Inch	h ₁ Inch	F370
1/8	28	9.73	1"	3/8	F3701/8X1
1/4	19	13.16	1.5/16	7/16	F3701/4X1.5/16
3/8	19	16.66	1.1/2	1/2	F3703/8X1.1/2
1/2	14	20.96	2"	5/8	F3701/2X2
5/8	14	22.91	2"	5/8	F3705/8X2
3/4	14	26.44	2"	5/8	F3703/4X2
7/8	14	30.20	2.1/4	11/16	F3707/8X2.1/4
1"	11	33.25	2.1/4	11/16	F3701X2.1/4
1.1/4	11	41.91	3"	7/8	F3701.1/4X3
1.1/2	11	47.80	4"	1"	F3701.1/2X4

F202

M

DIN
382

6g

1.75XP

HSS



- M 六角板牙
- M Cossinetes Sextavados
- M Terrajas, exterior hexagonal
- M Dienuts

F202

F202	▪	1.1	1.2	1.3	3.1	3.2	3.3	7.1	7.2	7.3						
	•	1.4	2.1	2.2	3.4	4.3	5.1	5.2	5.3	6.1	6.2	6.3	7.4	8.1	8.2	8.3

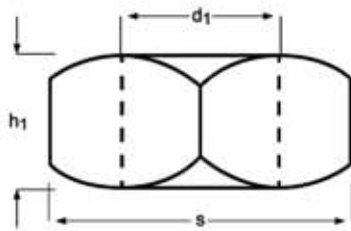

M	P mm	S mm	h ₁ mm	F202
3	0.50	19	5	F202M3
4	0.70	19	5	F202M4
5	0.80	19	7	F202M5
6	1.00	19	7	F202M6
7	1.00	22	9	F202M7
8	1.25	22	9	F202M8
10	1.50	27	11	F202M10
12	1.75	36	14	F202M12
14	2.00	36	14	F202M14
16	2.00	41	18	F202M16
18	2.50	41	18	F202M18
20	2.50	41	18	F202M20
22	2.50	50	22	F202M22
24	3.00	50	22	F202M24
27	3.00	60	25	F202M27
30	3.50	60	25	F202M30
36	4.00	60	25	F202M36

F302



- M 六角板牙
- M Cossinetes Sextavados
- M Terrajas, exterior hexagonal
- M Dienuts

F302

F302	▪	1.1	1.2	1.3	3.1	3.2	3.3	7.1	7.2	7.3						
	•	1.4	2.1	2.2	3.4	4.3	5.1	5.2	5.3	6.1	6.2	6.3	7.4	8.1	8.2	8.3

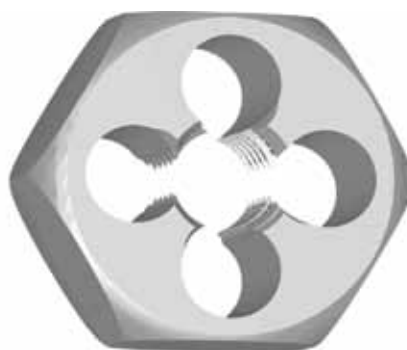
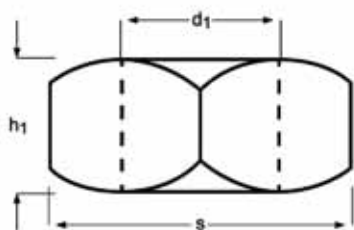

M	P mm	S decimal Inch	h ₁ Inch	F302
3	0.50	0.7100	1/4	F302M3
4	0.70	0.7100	1/4	F302M4
5	0.80	0.7100	1/4	F302M5
6	1.00	0.7100	1/4	F302M6
7	1.00	0.8200	5/16	F302M7
8	1.25	0.8200	5/16	F302M8
10	1.50	0.9200	3/8	F302M10
11	1.50	1.0100	7/16	F302M11
12	1.75	1.1000	1/2	F302M12
14	2.00	1.3000	5/8	F302M14
16	2.00	1.3000	5/8	F302M16
18	2.50	1.4800	11/16	F302M18
20	2.50	1.4800	11/16	F302M20
22	2.50	1.6700	13/16	F302M22
24	3.00	2.0500	15/16	F302M24
27	3.00	2.2200	1.1/16	F302M27
30	3.50	2.2200	1.1/16	F302M30
33	3.50	2.5800	1.1/8	F302M33
36	4.00	2.7600	1.1/4	F302M36

F312



- MF 六角板牙
- MF Cossinetes Sextavados
- MF Terrajas, exterior hexagonal
- MF Dienuts

F312

F312	▪	1.1	1.2	1.3	3.1	3.2	3.3	7.1	7.2	7.3							
	•	1.4	2.1	2.2	3.4	4.3	5.1	5.2	5.3	6.1	6.2	6.3	7.4	8.1	8.2	8.3	

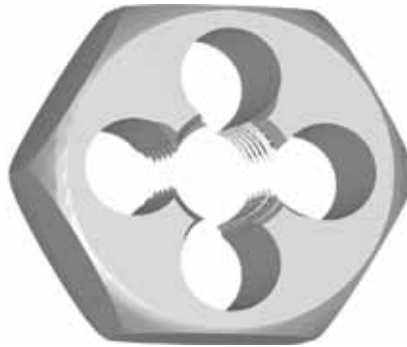
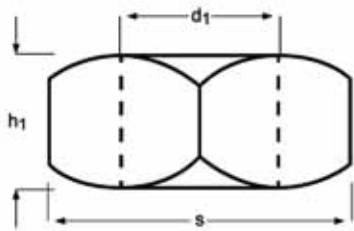

MF	P mm	S decimal Inch	h ₁ Inch	F312
8	0.75	0.8200	5/16	F312M8X.75
8	1.00	0.8200	5/16	F312M8X1.0
10	1.00	0.9200	3/8	F312M10X1.0
10	1.25	0.9200	3/8	F312M10X1.25
12	1.00	1.0100	7/16	F312M12X1.0
12	1.25	1.0100	7/16	F312M12X1.25
12	1.50	1.0100	7/16	F312M12X1.5
14	1.50	1.3000	5/8	F312M14X1.5
16	1.50	1.3000	5/8	F312M16X1.5
18	1.50	1.4800	11/16	F312M18X1.5
20	1.50	1.4800	11/16	F312M20X1.5
22	1.50	1.6700	13/16	F312M22X1.5
24	1.50	2.0500	15/16	F312M24X1.5
24	2.00	2.0500	15/16	F312M24X2.0

F272



- G(BSP) 六角板牙
- G(BSP) Cossinetes Sextavados
- G(BSP) Terrajas, exterior hexagonal
- G(BSP) Dienuts

F272

F272	▪	1.1	1.2	1.3	3.1	3.2	3.3	7.1	7.2	7.3						
	•	1.4	2.1	2.2	3.4	4.3	5.1	5.2	5.3	6.1	6.2	6.3	7.4	8.1	8.2	8.3

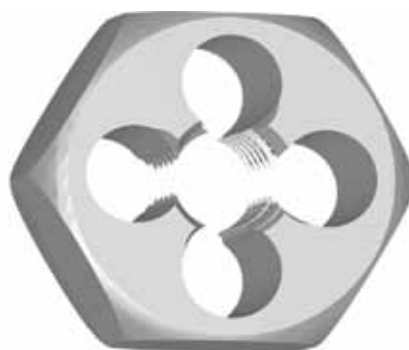
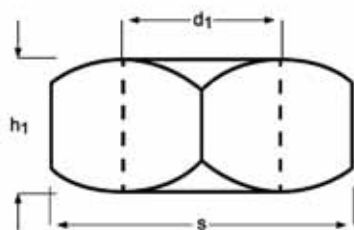

G(BSP)	TPI	d ₁ nom mm	S mm	h ₁ mm	F272
1/8	28	9.73	27	11	F2721/8
1/4	19	13.16	36	10	F2721/4
3/8	19	16.66	41	14	F2723/8
1/2	14	20.96	41	14	F2721/2
3/4	14	26.44	60	18	F2723/4
1"	11	33.25	60	18	F2721
1.1/4	11	41.91	70	20	F2721.1/4
1.1/2	11	47.80	85	22	F2721.1/2

C110	404	C346	417	C800	439	D200	452
C122	416	C352	412	C801	442	D400	461
C123	406	C353	409	C810	440	D402	462
C126	404	C358	414	C820	444	D420	461
C135	408	C359	425	C822	443	D422	462
C139	406	C365	426	C825	441	D745	454
C159	413	C367	411	C830	448	D747	456
C166	424	C400	434	C831	449	D750	460
C167	415	C403	435	C835	447	D751	460
C169	413	C407	431	C837	446	D752	459
C246	420	C413	434	C903	419	D753	459
C247	420	C428	429	C907	418	D763	452
C273	422	C429	435	C908	431		
C295	422	C492	430	C920	419		
C299	418	C500	436	C921	433		
C305	412	C503	436	C922	428		
C306	409	C505	437	C944	432		
C324	427	C511	438	C948	432		
C333	425	C700	451				
C336	414	C710	450				



S216	372	S524	383	S714	362	S804HB	368
S217	374	S525	378	S715	363	S812HA	356
S218	375	S526	379	S717	374	S812HB	356
S219	369	S527	380	S718	375	S813HA	358
S225	378	S529	394	S739	402	S813HB	358
S226	379	S531	395	S740	402	S814HA	370
S227	380	S533	396	S741	402	S814HB	370
S229	391	S534	398	S761	376	S902	360
S231	392	S535	399	S763	386	S903	361
S233	393	S536	390	S765	381	S904	373
S260	376	S610	366	S766	377	S922	360
S262	387	S611	367	S767	389	S933	361
S264	382	S612	371	S802HA	355	S944	373
S501	397	S629	401	S802HB	355	S991	403
S511	400	S637	364	S803HA	357		
S521	384	S638	365	S803HB	357		
S523	385	S710	359	S804HA	368		

材料	Material	Material	Material
应用	Aplicação	Aplicaciones	Application
类型	Tipo	Tipo	Type
刀齿 (z)	Nº de Cortes	Dientes	teeth (z)
切削长度	Comprimento de corte	Longitud de corte	Cut length
螺旋角	Ângulo de hélice / Ângulo de saída	Ângulo de hélice / Ângulo de salida	Helix angle/ Rake angle
柄部	Haste	Mango	Shank
涂层	Tratamento	Tratamiento superficial	Coating
公差	Tolerância	Tolerancia	Tolerance
加工方向	Direção	Dirección	Direction
标准	Norma	Estándar	Standard
■ 性能卓越	Excelente para a Aplicação	Excelente para Aplicación	Excellent for Application
■ 性能良好	Bom para a Aplicação	Bueno para Aplicación	Good for Application
实例 10 = 外缘处的切削速度, 米/分, +/- 10%	Exemplo 10 = Velocidade periférica em metros/minuto +/- 10%	Ejemplo 10 = Velocidad Periférica en metros/ minuto +/- 10%	Example 10 = Peripheral speed in metres/minute +/- 10%
产品型号	Código	Código de producto	Product Codes
尺寸范围	Gama de medidas	Rango de Diámetros	Size Range

AMG	中文	Português	Español	English
1.1	铁磁性低碳钢	Aço macio magnético	Acero blando	Magnetic soft steel
1.2	结构钢, 表面渗碳钢	Aço estrutural, Aço cementado	Acero de construcción/cementación	Structural steel, case carburizing steel
1.3	普通碳钢	Aço-carbono	Acero al carbono	Plain Carbon steel
1.4	合金钢	Aço de liga	Acero aleado	Alloy steel
1.5	合金钢, 淬火回火钢	Aço de liga, Aço temperado	Acero aleado/temple y revenido	Alloy steel, Hardened and tempered steel
1.6	合金钢, 淬火回火钢	Aço de liga, Aço temperado	Acero aleado/temple y revenido	Alloy steel, Hardened and tempered steel
1.7	热处理合金钢	Aço de liga temperado	Acero aleado cementado	Alloy steel, Heat treated
1.8	淬火合金钢, 耐磨钢	Aço de liga temperado	Acero aleado cementado	Alloy steel, Hardened & Wear resistant steel
2.1	易切削不锈钢	Aço inoxidável de maquinação fácil	Acero inoxidable fácil mecanizado	Free machining, Stainless Steel
2.2	奥氏体不锈钢	Austenítico	Austenítico	Austenitic
2.3	铁素体 + 奥氏体, 马氏体不锈钢	Ferrítico + Austenítico + Martensítico	Ferrítico, Ferr. + Aust., Marten	Ferritic + Austenitic, Ferritic, Martensitic
2.4	沉淀硬化不锈钢	Aço inoxidável de fácil usinagem	Acero Inoxidable Templado	Precipitation Hardened
3.1	灰铸铁	Grafite laminar	Con grafito laminar	Lamellar graphite
3.2	灰铸铁	Grafite laminar	Con grafito laminar	Lamellar graphite
3.3	球墨铸铁, 可锻铸铁	Grafite nodular/ Ferro fundido maleável	Con graf. laminar, fundic. maleable	Nodular graphite, Malleable Cast Iron
3.4	球墨铸铁, 可锻铸铁	Grafite nodular/ Ferro fundido maleável	Con graf. laminar, fundic. maleable	Nodular graphite, Malleable Cast Iron
4.1	纯钛	Titânio, sem liga	Titanio no aleado	Titanium, unalloyed
4.2	钛合金	Titânio, com liga	Titanio aleado	Titanium, alloyed
4.3	钛合金	Titânio, com liga	Titanio aleado	Titanium, alloyed
5.1	纯镍	Níquel, sem liga	Níquel no aleado	Nickel, unalloyed
5.2	镍合金	Níquel, com liga	Níquel aleado	Nickel, alloyed
5.3	镍合金	Níquel, com liga	Níquel aleado	Nickel, alloyed
6.1	紫铜	Cobre	Cobre	Copper
6.2	β黄铜, 青铜	Latão beta, bronze	β-Latón, bronce	β-Brass, Bronze
6.3	α黄铜	Latão alfa	α-Latón	α-Brass
6.4	高强度青铜	Bronze de alta resistência	Metal AMPCO	High Strength Bronze
7.1	纯铝, 纯镁	Al, Mg, sem liga	Al, Mg, no aleado	Al, Mg, unalloyed
7.2	铝合金, 硅含量 < 0.5%	Al com liga, Si<0.5%	Al aleado con Si < 0.5%	Al alloyed, Si < 0.5%
7.3	铝合金, 硅含量 > 0.5% < 10%	Al com liga, Si>0.5%<10%	Al aleado con Si > 0.5% < 10%	Al alloyed, Si > 0.5% < 10%
7.4	铝合金, 硅含量 > 10% 晶须增强铝合金, 镁合金	Al com liga, Si>10% reforçadas com monocristais filiformes, ligas de Al/Mg	Al aleado, Si>10% Reforzado por filamentos, Al-aleados, Mg-aleados	Al alloyed, Si > 10% Whisker reinforced Al-alloys Mg-alloys
8.1	热塑性塑料	Termoplásticos	Termoplásticos	Thermoplastics
8.2	热固性塑料	Plásticos termóduros	Plásticos endurecidos por calor	Thermosetting plastics
8.3	增强塑料	Materiais plásticos reforçados	Materiales plásticos reforzados	Reinforced plastic materials
9.1	金属陶瓷	Cerametal (metalocerâmica)	Cermetales (metales-cerámicas)	Cermets (metals-ceramics)
10.1	标准石墨	Grafite standard	Grafito standard	Graphite















	HM	HM	HM	HM	HM	HM	HM	HM	HM	HM	HM	HM	HM	HM	
	N	N	N	N	N	N	N	N	N	N	N	N	N	N	
	Z ₂	Z ₂	Z ₂	Z ₂	Z ₃	Z ₃	Z ₃	Z ₃	Z ₂	Z ₂	Z ₂	Z ₃	Z ₃	Z ₃	
	λ30° γ9°	λ30° γ9°	λ30° γ9°	λ30° γ9°	λ30° γ9°	λ30° γ9°	λ30° γ9°	λ30° γ9°	λ40° γ10°	λ30° γ12°	λ30° γ12°	λ30° γ12°	λ30° γ12°	λ40° γ10°	
									h9	h10	h10	h10	h10	h9	
	S802HA	S802HB	S812HA	S812HB	S803HA	S803HB	S813HA	S813HB	S710	S902	S922	S903	S933	S714	
	1.00 - 20.00	1.80 - 20.00	2.00 - 20.00	2.00 - 20.00	1.00 - 20.00	1.80 - 20.00	2.00 - 20.00	2.00 - 20.00	1.00 - 20.00	2.00 - 20.00	2.00 - 20.00	2.00 - 20.00	2.00 - 20.00	3.00 - 20.00	
									NEW					NEW	
AMG	355	355	356	356	357	357	358	358	359	360	360	361	361	362	ISO
1.1	■260B	■260B	■210B	■210B	■260B	■260B	■210B	■210B	■140C	■65B	■95B	■65B	■95B	■110C	P 1
1.2	■260B	■260B	■210B	■210B	■260B	■260B	■210B	■210B	■140C	■65B	■95B	■65B	■95B	■110C	P 1
1.3	■155B	■155B	■125B	■125B	■155B	■155B	■125B	■125B	■130C	■55B	■80B	■55B	■80B	■100C	P 2
1.4	■155B	■155B	■125B	■125B	■155B	■155B	■125B	■125B	■130C	■50B	■75B	■50B	■75B	■100C	P 3
1.5	■115B	■115B	■90B	■90B	■115B	■115B	■90B	■90B	■120C	■30B	■45B	■30B	■45B	■95C	P 4
1.6	■90B	■90B	■75B	■75B	■90B	■90B	■75B	■75B		■30B		■30B			H 1
1.7															H 3
1.8															H 4
2.1	■105A	■105A	■75A	■75A	■105A	■105A	■85A	■85A	■80B					■65B	M 1
2.2	■70A	■70A	■55A	■55A	■70A	■70A	■55A	■55A	■70B					■55B	M 3
2.3	■70A	■70A	■55A	■55A	■70A	■70A	■55A	■55A							M 2
2.4	■50A	■50A			■50A	■50A									S 2
3.1	■180B	■180B	■145B	■145B	■180B	■180B	■145B	■145B	■170C	■55B	■80B	■55B	■80B	■135C	K 1
3.2	■110B	■110B	■85B	■85B	■110B	■110B	■85B	■85B	■150C	■30B	■45B	■30B	■45B	■120C	K 2
3.3	■145B	■145B	■115B	■115B	■145B	■145B	■115B	■115B	■130C	■55B	■80B	■55B	■80B	■100C	K 3
3.4	■95B	■95B	■75B	■75B	■95B	■95B	■75B	■75B	■120C	■30B	■45B	■30B	■45B	■95C	K 4
4.1	■170B	■170B	■140B	■140B	■170B	■170B	■140B	■140B		■65B	■95B	■65B	■95B		S 1
4.2	■115B	■115B	■90B	■90B	■115B	■115B	■90B	■90B	■70B	■30B	■45B	■30B	■45B	■55B	S 2
4.3										■15B	■20B	■15B	■20B		S 3
5.1	■165B	■165B	■130B	■130B	■165B	■165B	■130B	■130B		■65B	■95B	■65B	■95B		S 1
5.2	■35A	■35A	■25A	■25A	■35A	■35A	■25A	■25A	■70B					■55B	S 2
5.3															S 3
6.1	■320C	■320C	■255C	■255C	■320C	■320C	■255C	■255C		■110C	■155C	■110C	■155C	■200E	N 3
6.2	■320C	■320C	■255C	■255C	■320C	■320C	■255C	■255C		■110C	■155C	■110C	■155C	■190E	N 4
6.3	■320C	■320C	■255C	■255C	■320C	■320C	■255C	■255C		■110C	■155C	■110C	■155C	■175E	N 3
6.4	■40B	■40B	■30C	■30C	■40B	■40B	■30C	■30C		■15B	■20B	■15B	■20B	■160E	N 4
7.1	■800C	■800C	■640C	■640C	■800C	■800C	■640C	■640C		■275C	■390C	■275C	■390C	■200E	N 1
7.2	■800C	■800C	■640C	■640C	■800C	■800C	■640C	■640C		■275C	■390C	■275C	■390C	■190E	N 1
7.3	■480C	■480C	■380C	■380C	■480C	■480C	■380C	■380C		■165C	■235C	■165C	■235C	■175E	N 1
7.4	■240B	■240B	■190B	■190B	■240B	■240B	■190B	■190B						■160E	N 2
8.1	■320C	■320C	■255C	■255C	■320C	■320C	■255C	■255C		■110C	■155C	■110C	■155C		O
8.2	■320C	■320C	■255C	■255C	■320C	■320C	■255C	■255C		■110C	■155C	■110C	■155C		O
8.3										■30B	■45B	■30B	■45B		O
9.1															H
10.1															O

	HM	HM	HM	HM	HM	HM	HM	HM	HM	HM	HM	HM	HM	HM	
	N	W	W	W	W	N	N	N	N	N	N	N	N	N	
	Z 3	Z 1	Z 2	Z 2	Z 2	Z 4	Z 4	Z 4	Z 4	Z 4	Z 4	Z 4	Z 4	Z 4	
	λ40° γ10°	λ25° γ20°	λ30° γ20°	λ30° γ20°	λ30° γ20°	λ35° γ9°	λ35° γ9°	λ40° γ3°	λ35° γ9°	λ35° γ9°	λ40° γ10°	λ40° γ3°	λ30° γ12°	λ30° γ12°	
	DIN 8533HA	DIN 8533HA	DIN 8533HA	DIN 8533HA	DIN 8533HA	DIN 8533HA	DIN 8533HE	DIN 8533HA	DIN 8533HA	DIN 8533HE	DIN 8533HA	DIN 8533HA	DIN 8533HA	DIN 8533HE	
	ADON	H	H	H	H	ADON	ADON	ADON	ADON	ADON	Diamond	ADON	ADON	TAIN	
	h9	h9	h9	h9	h9	h10	h10	h9	h10	h10	h9	h9	h12	h12	
	EXDPOWER	EXDPOWER	EXDPOWER	EXDPOWER	EXDPOWER	DIN 6527K	DIN 6527K	EXDPOWER	DIN 6527L	DIN 6527L	EXDPOWER	EXDPOWER	EXDPOWER	EXDPOWER	
	S715	S637	S638	S610	S611	S804HA	S804HB	S219	S814HA	S814HB	S612	S216	S904	S944	
	3.00 - 20.00	2.00 - 12.00	6.20 - 20.30	3.00 - 20.00	6.00 - 20.00	2.00 - 25.00	2.00 - 25.00	3.00 - 20.00	2.00 - 25.00	2.00 - 25.00	1.00 - 12.00	2.00 - 20.00	2.00 - 20.00	2.00 - 20.00	
	NEW	NEW	NEW	NEW	NEW			NEW			NEW	NEW			
AMG	363	364	365	366	367	368	368	369	370	370	371	372	373	373	ISO
1.1	■70C					■360B	■360B		■270B	■270B			■95B	■140B	P 1
1.2	■70C					■300B	■300B		■225B	■225B			■95B	■140B	P 1
1.3	■65C					■230B	■230B		■175B	■175B			■80B	■120B	P 2
1.4	■65C					■230B	■230B		■175B	■175B			■70B	■105B	P 3
1.5	■60C					■165B	■165B		■125B	■125B			■55B	■80B	P 4
1.6						■130B	■130B	■90C	■100B	■100B		■90C	■30B	■45B	H 1
1.7															H 3
1.8															H 4
2.1	■40B					■165A	■165A		■125A	■125A					M 1
2.2	■35B					■110A	■110A		■85A	■85A					M 3
2.3						■110A	■110A	■70B	■85A	■85A		■70B			M 2
2.4						■75A	■75A	■50B				■50B			S 2
3.1	■85C					■275B	■275B		■205B	■205B			■80B	■120B	K 1
3.2	■75C					■165B	■165B		■125B	■125B			■55B	■80B	K 2
3.3	■65C					■165B	■165B		■125B	■125B			■70B	■105B	K 3
3.4	■60C					■135B	■135B		■105B	■105B			■55B	■80B	K 4
4.1						■275B	■275B		■205B	■205B			■95B	■140B	S 1
4.2	■35B					■140B	■140B		■105B	■105B			■40B	■60B	S 2
4.3								■50B				■50B	■30B	■45B	S 3
5.1						■275B	■275B		■205B	■205B			■135B	■200B	S 1
5.2	■35B					■55A	■55A		■40A	■40A			■30A	■45A	S 2
5.3								■50B				■50B	■25A	■35A	S 3
6.1	■350E	■400E	■350E	■280E	■320C	■320C	■320C		■255C	■255C			■110C	■155C	N 3
6.2	■300E	■345E	■300E	■240E	■320C	■320C	■320C		■255C	■255C			■110C	■155C	N 4
6.3	■250E	■290E	■250E	■200E	■320C	■320C	■320C		■255C	■255C			■110C	■155C	N 3
6.4	■200E	■230E	■200E	■160E	■40B	■40B	■40B		■32C	■32C			■15B	■20B	N 4
7.1	■600E	■690E	■600E	■480E	■800C	■800C	■800C		■640C	■640C			■275C	■390C	N 1
7.2	■500E	■575E	■500E	■400E	■800C	■800C	■800C		■640C	■640C			■275C	■390C	N 1
7.3	■400E	■460E	■400E	■320E	■480C	■480C	■480C		■380C	■380C			■165C	■235C	N 1
7.4	■350E	■400E	■350E	■280E	■240B	■240B	■240B		■190B	■190B					N 2
8.1	■800E	■980E	■800E	■640E	■320C	■320C	■320C		■255C	■255C			■110C	■155C	O
8.2	■800E	■980E	■800E	■640E	■320C	■320C	■320C		■255C	■255C			■110C	■155C	O
8.3													■55B	■80B	O
9.1															H
10.1											■350A				O

	HM	HM	HM	HM	HM	HM	HM	HM	HM	HM	HM	HM	HM	HM	HM	HM	
	N	N	N	N	N	N	N	N	N	N	N	N	N	NR	NR	N	
	Z 4	Z 4	Z 4	Z 4	Z 4	Z 4	Z 4	Z 4	Z 6-8	Z 6-8	Z 6-8	Z 6-8	Z 6-8	Z 6-8	Z 4	Z 4	
	λ 40° γ 10°	λ 40° γ 3°	λ 40° γ 10°	λ 40° γ 3°	λ 40° γ 10°	λ 40° γ 4°	λ ≠ γ 10°	λ 50° γ 3°	λ 50° γ 26°	λ 50° γ 3°	λ 50° γ 26°	λ 50° γ 3°	λ 50° γ 26°	λ 40° γ 10°	λ 40° γ 4°	λ 40° γ 6°	
	DIN 8533HA	DIN 8533HA	DIN 8533HA	DIN 8533HA	DIN 8533HA	DIN 8533HA	DIN 8533HA	DIN 8533HA	DIN 8533HA	DIN 8533HA	DIN 8533HA	DIN 8533HA	DIN 8533HA	DIN 8533HA	DIN 8533HE	DIN 8533HA	
	AGN	ATH	AGN	ATH	AGN	AGN	TBN	ATH	TBN	ATH	TBN	ATH	TBN	AGN	AGN	TBN	
	h9	h9	h9	h9	h9	h9	h9	h9	h9	h9	h9	h9	h9	h9	h9	h9	
	S717	S217	S718	S218	S761	S260	S766	S225	S525	S226	S526	S227	S527	S765	S264	S524	
	3.00 - 20.00	3.00 - 20.00	3.00 - 20.00	3.00 - 20.00	3.00 - 20.00	3.00 - 20.00	4.00 - 20.00	3.00 - 20.00	3.00 - 20.00	3.00 - 20.00	3.00 - 20.00	6.00 - 20.00	3.00 - 20.00	6.00 - 20.00	6.00 - 20.00	3.00 - 16.00	
	NEW	NEW	NEW	NEW	NEW	NEW	NEW	NEW	NEW	NEW	NEW	NEW	NEW	NEW	NEW	NEW	
AMG	374	374	375	375	376	376	377	378	378	379	379	380	380	381	382	383	ISO
1.1	■110C		■70C		■140D		■140D							■140D			P 1
1.2	■110C		■70C		■140D		■140D							■140D			P 1
1.3	■100C		■65C		■130D		■130D							■130D			P 2
1.4	■100C		■65C		■130D		■130D							■130D			P 3
1.5	■95C		■60C		■120D		■120D							■120D			P 4
1.6		■72C		■45C		■110D		■90C		■72C		■45C			■110D		H 1
1.7					■85B			■70A		■56A		■35A		■85B	■56A		H 3
1.8							■50A		■40A		■25A			■40A			H 4
2.1	■65B		■40B		■80C		■80C							■80C			M 1
2.2	■55B		■35B		■70C		■70C							■70C			M 3
2.3		■56B		■35B		■70C		■70B		■56B		■35B			■70C		M 2
2.4		■40B		■25B		■50C		■50B		■40B		■25B		■50C			S 2
3.1	■135C		■85C		■170D		■170D							■170D			K 1
3.2	■120C		■75C		■150D		■150D							■150D			K 2
3.3	■100C		■65C		■130D		■130D							■130D			K 3
3.4	■95C		■60C		■120D		■120D							■120D			K 4
4.1																	S 1
4.2	■55B		■35B		■70C		■70C							■70C			S 2
4.3		■40B		■25B		■50C		■50B		■40B		■25B		■50C			S 3
5.1																	S 1
5.2	■55B		■35B		■70C		■70C							■70C			S 2
5.3		■40B		■25B		■50C		■50B		■40B		■25B		■50C			S 3
6.1																	N 3
6.2																	N 4
6.3																	N 3
6.4																	N 4
7.1																	N 1
7.2																	N 1
7.3																	N 1
7.4																	N 2
8.1																	O
8.2																	O
8.3																	O
9.1																	H
10.1																	O

	HM	HM	HM	HM	HM	HM	HM	HM	HM	HM	HM	HM	HM	HM			
	N	N	N	N	N	N	N	N	N	N	N	N	N	N			
	Z 4	Z 4	Z 4	Z 4	Z 4	Z 4	Z 2	Z 2	Z 2	Z 2	Z 2	Z 2	Z 2	Z 4			
	λ45° γ-10°	λ40° γ-6°	λ40° γ-10°	λ40° γ-4°	λ≠ γ10°	λ25° γ0°	λ30° γ3°	λ30° γ3°	λ30° γ3°	λ30° γ-10°	λ30° γ-10°	λ30° γ-10°	λ30° γ-10°	λ30° γ-10°			
	h9	h9	h9	h9	h9	h9	h9	h9	h9	h9	h9	h9	h9	h9			
	S521	S523	S763	S262	S767	S536	S229	S231	S233	S529	S531	S533	S501	S534			
	3.00 - 16.00	1.50 - 16.00	3.00 - 20.00	3.00 - 20.00	4.00 - 20.00	6.00 - 12.00	1.50 - 16.00	1.50 - 16.00	2.00 - 16.00	1.50 - 16.00	1.50 - 16.00	2.00 - 16.00	1.00 - 16.00	3.00 - 16.00			
	NEW	NEW	NEW	NEW	NEW	NEW	NEW	NEW	NEW	NEW	NEW	NEW	NEW	NEW			
AMG	384	385	386	387	389	390	391	392	393	394	395	396	397	398	ISO		
1.1			■140D		■140D										■181B	P 1	
1.2			■140D		■140D										■181B	P 1	
1.3			■130D		■130D										■118B	P 2	
1.4			■130D		■130D										■118B	P 3	
1.5			■120D		■120D										■90B	P 4	
1.6				■110D			■630C	■500C	■315C						■72B	H 1	
1.7	■70A	■70A		■85B		■105E				■330A	■260A	■165A			■45A	■330A	H 3
1.8	■50A	■50A				■75E				■280A	■225A	■140A				■280A	H 4
2.1			■80C		■80C										■81A		M 1
2.2			■70C		■70C										■54A		M 3
2.3				■70C			■540B	■430B	■270B						■54A		M 2
2.4				■50C			■315B	■250B	■155B								S 2
3.1			■170D		■170D										■136B		K 1
3.2			■150D		■150D										■81B		K 2
3.3			■130D		■130D										■109B		K 3
3.4			■120D		■120D										■72B		K 4
4.1															■136B		S 1
4.2			■70C		■70C										■90B		S 2
4.3				■50C			■315B	■250B	■155B						■45B		S 3
5.1															■136B		S 1
5.2			■70C		■70C										■27A		S 2
5.3				■50C			■315B	■250B	■155B						■22A		S 3
6.1															■363C		N 3
6.2															■363C		N 4
6.3															■363C		N 3
6.4															■54B		N 4
7.1															■950C		N 1
7.2															■950C		N 1
7.3															■681C		N 1
7.4															■363B		N 2
8.1															■318C		O
8.2															■318C		O
8.3															■318B		O
9.1															■5A		H
10.1																	O

	HM	HM	HM	HM	HM	HM		HSS-E PM	HSS-E PM	HSS-E PM	HSS-E PM	HSS-E	
	N	N	W	N	N	N		N	N	N	N	N	
	Z ₄	Z ₄	Z ₂	Z ₂	Z ₂	Z ₂		Z ₂	Z ₂	Z ₂	Z ₂	Z ₂	
	λ 30° γ 10°	λ 30° γ 10°	λ 30° γ 15°	λ 40° γ 10°	λ 40° γ 10°	λ 40° γ 10°		λ 30° γ 12°	λ 30° γ 12°	λ 30° γ 12°	λ 30° γ 12°	λ 30° γ 12°	
	DIN 8533HA	DIN 8533HA	DIN 8533HA	DIN 8533HA	DIN 8533HA	DIN 8533HA		DIN 1835E	DIN 1835E	DIN 1835E	DIN 1835E	DIN 1835E	
	TBN	ICEED	Hi	ATN	ATN	ATN		TBN	TBN	TBN	TBN	TBN	
	h9	h9	h9	h9	h9	h9		e8	e8	e8	e8	e8	
	EXTPOWER	EXTPOWER	EXTPOWER	EXTPOWER	EXTPOWER	EXTPOWER		DIN 327D	DIN 327D	DIN 844K	DIN 844K	EXTPOWER	
	S535	S511	S629	S739	S740	S741	S991	C110	C126	C123	C139	C135	
	3.00 - 16.00	3.00 - 16.00	3.00 - 20.00	3.00 - 20.00	3.00 - 20.00	3.00 - 20.00	Set	1.00 - 50.00	1.00 - 30.00	1/16 - 40.00	2.00 - 30.00	2.00 - 30.00	
	NEW		NEW	NEW	NEW	NEW							
AMG	399	400	401	402	402	402	403	404	404	406	406	408	ISO
1.1		■230B		■140C	■140C	■140C		■60A	■135A	■55A	■120A	■50A	P 1
1.2		■192B		■140C	■140C	■140C		■50A	■105A	■45A	■95A	■40A	P 1
1.3		■153B		■130C	■130C	■130C		●40B	■95B	■40B	■85B	●35B	P 2
1.4		■153B		■130C	■130C	■130C		●35B	■80B	■35B	■70B	●30B	P 3
1.5		■115B		■120C	■120C	■120C			●55C		●50C		P 4
1.6		■92B							●25C		●20C		H 1
1.7	■260A	●61A											H 3
1.8	■225A												H 4
2.1		■115A		■80B	■80B	■80B		●30F	●45F	●25F	●45F	●25F	M 1
2.2		■76A		■70B	■70B	■70B							M 3
2.3		■76A							●25F		●25F		M 2
2.4													S 2
3.1		■192B		■170C	■170C	■170C		●35A	■60A	●30A	■55A	●30A	K 1
3.2		■115B		■155C	■155C	■155C		●30A	■50A	●25A	■45A	●25A	K 2
3.3		■115B		■145C	■145C	■145C		●50B	■90B	●45B	■80B	●40B	K 3
3.4		■96B		■130C	■130C	■130C		●30B	■55B	●30B	■50B	●25B	K 4
4.1		■192B						■35D	■45D	■30D	■45D	●30D	S 1
4.2		■96B		■70B	■70B	■70B		●25D	■40D	●25D	■35D	●25D	S 2
4.3		■61B							●15D		■15D		S 3
5.1		■192B						■60D	■130D	■50D	■115D	■50D	S 1
5.2		■38A		■70B	■70B	■70B		●15C	■25C	●15C	■25C	●15C	S 2
5.3		■30A							●10D		●10D		S 3
6.1		●384C	■350E	■250E	■250E	■250E		■35C	■190C	■80C	■170C	■70C	N 3
6.2		●384C	■300E	■235E	■235E	■235E		■35C	■190C	■80C	■170C	■70C	N 4
6.3		●384C	■250E	■220E	■220E	■220E		■35C	■190C	■80C	■170C	■70C	N 3
6.4		●61B	■200E	■200E	■200E	■200E			●25C		●25C		N 4
7.1		●950C	■600E	■250E	■250E	■250E		●220E	●480E	●200E	●435E	●180E	N 1
7.2		●950C	■500E	■235E	■235E	■235E		●220E	●480E	●200E	●435E	●180E	N 1
7.3		■576C	■400E	■220E	■220E	■220E		●85E	●190E	●80E	●170E	●70E	N 1
7.4		■307B	■350E	■200E	■200E	■200E			●95A		●85A		N 2
8.1		●307C	■800E					●90C	●190C	●80C	●175C	●70C	O
8.2		■307C	■800E										O
8.3		■307B											O
9.1		■9A											H
10.1													O









HSS-E PM	HSS-E PM	HSS-E PM	HSS-E PM	HSS-E PM	HSS-E	HSS-E	HSS-E PM	HSS-E PM	HSS-E	HSS-E	HSS-E	HSS-E PM	HSS-E PM	HSS-E PM
P9	P9	P9	P9	P9	P9	P9	P9	P9				P9	P9	P9
N	N	N	N	N	W	W	W	W	N	N	N	N	N	N
Z3	Z3	Z3	Z3	Z3	Z2	Z2	Z3	Z3	Z2	Z2	Z3	Z3-5	Z3-6	Z3-6
30°/12°	30°/12°	40°/15°	30°/12°	30°/12°	40°/20°	40°/20°	40°/25°	40°/25°	30°/12°	30°/12°	30°/12°	45°/12°	45°/12°	45°/12°
DIN 1895E	DIN 1895E	DIN 1895E	DIN 1895E	DIN 1895E	DIN 1895E	DIN 1895E	DIN 1895E	DIN 1895E	DIN 1895A	DIN 1895A	DIN 1895E	DIN 1895E	DIN 1895E	DIN 1895E
AXORON	AXORON	AXORON	AXORON	AXORON			TDON	AXORON			AXORON	AXORON	AXORON	AXORON
e8 h10	e8 h10	e8	e8	e8	e8	e8	k10	k10	js14	e8	e8	k10	k10	k10
DIN 327D	DIN 327D	DIN 327D	DIN 844K	DIN 844K	DIN 844K	DIN 844K	DIN 844K	DIN 844K	EXTRAPER	EXTRAPER	DIN 844L	DIN 844K	DIN 844K	DIN 844L
														
C306	C353	C367	C305	C352	C159	C169	C336	C358	C167	C122	C346	C299	C907	C903
3.00 - 30.00	3.00 - 30.00	2.00 - 20.00	2.00 - 20.00	3.00 - 20.00	2.00 - 20.00	2.00 - 20.00	10.00 - 30.00	10.00 - 30.00	6.00 - 16.00	5.00 - 30.00	3.00 - 20.00	3.00 - 25.00	3.00 - 32.00	6.00 - 25.00

AMG	409	409	411	412	412	413	413	414	414	415	416	417	418	418	419	ISO
1.1	53A	145A	146A	56A	135A	50A	100A	55A	133A	50A	45A	45A				P 1
1.2	49A	120A	117A	44A	105A	40A	80A	44A	106A	40A	36A	35A				P 1
1.3	41B	100B	102B	39B	95B	35B	70B	38B	93B	35B	31B	30B	37T	95T	35T	P 2
1.4	35B	35B	87B	33B	80B					30B	27B	25B	33T	80T	29T	P 3
1.5		60C			55C								22U	55U	20U	P 4
1.6		25C			25C								10U	25U	9U	H 1
1.7																H 3
1.8																H 4
2.1	26F	50F	67F	26F	50F	23F	34F	25F	48F	25F	20F	20F	26Y	50Y	23Y	M 1
2.2		45F	55F		40F	19F	29F	21F	40F				21Y	40Y	18Y	M 3
2.3		30F	35F		25F		18F		26F				13Y	25Y	13Y	M 2
2.4			25F													S 2
3.1	32A	65A		30A	60A					30A	25A	25A	30S	60S	27S	K 1
3.2	27A	55A		25A	50A					25A	20A	20A	25S	50S	22S	K 2
3.3	48B	95B		45B	90B					40B	36B	35B	45T	90T	39T	K 3
3.4	30B	60B		27B	55B					25B	22B	20B	27T	55T	24T	K 4
4.1	33D	50D	50D	29D	45D	28D	36D	30D	46D	30D	25D	25D	29V	45V	26V	S 1
4.2	26D	40D		24D	35D		29D		37D	25D	20D	20D	57V	85V	23V	S 2
4.3		20D			15D								10V	15V	10V	S 3
5.1	58D	140D	140D	51D	125D	48D	96D	52D	127	50D	43D	45D	51V	125V	47V	S 1
5.2	15C	30C		13C	25C		19D		27	15C	11C	10C	13U	25U	13U	S 2
5.3		15D			10D								5V	10V	5V	S 3
6.1	110C	210C	209C	100C	190C	100C	200C	100C	240C	75C	112C	70C				N 3
6.2	110C	210C	209C	100C	190C	100C	200C	100C	240C	75C	112C	70C	100U	190U	89U	N 4
6.3	110C	210C	209C	100C	190C	100C	200C	100C	240C	75C	112C	70C				N 3
6.4		30C			25C											N 4
7.1			528E			250E	500E	250E	600E	200E	270E	180E				N 1
7.2	219E	530E	528E	198E	480E	250E	500E	250E	600E	200E	270E	180E				N 1
7.3	86E	210E	209E	79E	190E	100E	200E	100E	240E	75E	81E					N 1
7.4		105A			95A				120A				39S	95S	35S	N 2
8.1	72C	210C	209C	65C	190C	100C	200C	100E	240A	80C	112C	70C				O
8.2						100C	200C	100E	240A							O
8.3																O
9.1																H
10.1																O

	HSS-E PM	HSS-E PM	HSS-E PM	HSS-E PM	HSS-E PM	HSS-E	HSS-E PM	HSS-E PM	HSS-E PM	HSS-E PM	HSS-E PM	HSS-E PM	HSS-E PM	HSS-E PM	HSS-E PM
	N	N	N	N	N	W	W	W	FS	HRA	HRA	HRA	HRA	NRA	NRA
	Z 3-5	Z 4-8	Z 4-6	Z 4-6	Z 4-6	Z 2	Z 3	Z 3	Z 3-4	Z 3	Z 3-4	Z 4-6	Z 3-6	Z 4-6	Z 4-6
	45° 12°	30° 12°	30° 12°	30° 12°	30° 12°	40° 20°	40° 25°	40° 25°	40° 25°	35° 12°	35° 12°	35° 12°	35° 12°	35° 12°	35° 12°
	DIN 1835E	DIN 1835E	DIN 1835E	DIN 1835E	DIN 1835E	DIN 1835E	DIN 1835E	DIN 1835E	DIN 1835E	DIN 1835E	DIN 1835E	DIN 1835E	DIN 1835E	DIN 1835E	DIN 1835E
	k10	k10	k10	k10	k10	e8	k10	k10	k10	k10	k12	k12	k12	k12	k12
	DIN 844L	DIN 844K	DIN 844K	DIN 844L	DIN 844L	DIN 844L	DIN 844L	DIN 844L	DIN 844L	DIN 327D	DIN 844K	DIN 844K	DIN 844L	DIN 844K	DIN 844K
	C920	C247	C246	C273	C295	C166	C333	C359	C365	C324	C922	C428	C492	C407	C908
	6.00 - 25.00	2.00 - 50.00	2.00 - 32.00	2.00 - 40.00	2.00 - 40.00	6.00 - 16.00	10.00 - 30.00	10.00 - 30.00	10.00 - 30.00	8.00 - 30.00	6.00 - 40.00	6.00 - 40.00	6.00 - 30.00	6.00 - 40.00	6.00 - 40.00

AMG	419	420	420	422	422	424	425	425	426	427	428	429	430	431	431	ISO
1.1		■55S	■120S	■50S	■110S	■45A	●49A	■119A	■55M					■55G		P 1
1.2		■45S	■95S	■50S	■85S	■36A	■95A	■44M	■44G					■44G		P 1
1.3	■85T	■40T	■85T	■35T	■75T	■31B	■83B	■38N		■100H	■95H	■93H	■83H	■38H	■93H	P 2
1.4	■70T	■35T	■70T	■30T	■65T					■85H	■30H	■79H	■71H	■33H	■79H	P 3
1.5	■50U		■50U		■45U					■60I	■55I	■54I	■49I	■22I	■54I	P 4
1.6	■20U		■20U		■20U					■25I	■25I	■24I	■21I	■10I	■24I	H 1
1.7																H 3
1.8																H 4
2.1	■45Y	■25Y	■45Y	■10Y	■40Y	■20F	■22F	■43F	■25R	■50L	■50L	■48L	■43L	■25L	■48L	M 1
2.2	■35Y					■17F	■19F	■36F		■45L	■40L	■40L	■36L	■21L	■40L	M 3
2.3	■25Y		■25Y		■20Y			■23F		■30L	■25L	■26L	■23L	■13L	■26L	M 2
2.4																S 2
3.1	■55S	■30S	■55S	■25S	■50S					■65G	■60G	■61G	■55G	■30G	■61G	K 1
3.2	■45S	■25S	■45S	■20S	■40S					■55G	■50G	■50G	■45G	■25G	■50G	K 2
3.3	■80T	■45T	■79T	■40T	■70T					■95H	■90H	■88H	■79H	■44H	■88H	K 3
3.4	■50T	■25T	■49T	■25T	■45T					■60H	■55H	■55H	■49H	■27H	■55H	K 4
4.1	■40V	■30V	■43V	■25V	■40V	■25D	■27D	■41D	■30P	■50J	■45J	■46J	■41J	■30J	■46J	S 1
4.2	■35V	■25V	■35V	■20V	■30V			■34D		■40J	■35J	■37J	■34J	■25J	■37J	S 2
4.3	■15V		■15V		■15V					■20J	■15J	■16J	■15J	■11J	■16J	S 3
5.1	■115V	■50V	■116V	■45V	■105V	■43D	■47D	■114D	■52P	■140J	■125J	■127J	■114J	■52J	■127J	S 1
5.2	■25U	■15U	■24U	■10U	■20U			■24D		■30I	■25I	■27I	■24I	■14I	■27I	S 2
5.3	■10V		■10V		■10V					■15J	■10J	■11J	■10J	■6J	■11J	S 3
6.1		■80U	■170U	■70U	■155U	■90C	■123C	■235C	■1000							N 3
6.2		■170U	■80U	■170U	■70U	■155U	■90C	■235C	■1000	■210I	■190I	■190I	■170I	■100I	■190I	N 4
6.3		■80U	■170U	■70U	■155U	■90C		■1000								N 3
6.4			■25U		■20U					■30I	■25I	■25I	■23I	■13I	■25I	N 4
7.1		■200X	■435X	■180X	■390X	■225E	■297E	■718E	■250Q							N 1
7.2		■200X	■435X	■180X	■390X	■225E	■297E	■718E	■250Q							N 1
7.3		■80X	■170X	■70X	■155X	■90E	■89E	■215E	■100Q							N 1
7.4	■85S		■85S		■75S			■120A		■105G	■95G	■95G	■85G	■39G	■95G	N 2
8.1		■80U	■175U	■70U	■155U	■90C			■1000							O
8.2						■90C			■1000							O
8.3																O
9.1																H
10.1																O

	HSS-E PM	HSS-E PM	HSS-E PM	HSS-E	HSS-E	HSS-E	HSS-E	HSS-E	HSS-E	HSS-E	HSS-E	HSS	HSS-E		
	Z 4-6	Z 4-6	Z 3-6	Z 4-6	Z 4-6	Z 4-6	Z 4-6	Z 2	Z 2	Z 2	Z 2	Z 6-8	Z 6-8	Z 6-12	
	6.00 - 40.00	6.00 - 32.00	6.00 - 32.00	6.00 - 50.00	6.00 - 32.00	10.00 - 50.00	10.00 - 32.00	2.00 - 25.00	2.00 - 25.00	3.00 - 30.00	3.00 - 25.00	11.00 - 50.00	12.50 - 1.61/64	40.00 - 63.00	
AMG	432	432	433	434	434	435	435	436	436	437	438	439	440	441	ISO
1.1				50G	100G	45G	90G	55S	110S	50S	50S	35P	25P	35P	P 1
1.2				40G	80G	35G	70G	45S	90S	40S	40S	35P	25P	30P	P 1
1.3	34H	33H	96N	35H	70H	30H	65H	40T	75T	35T	35T	30O	20O	30O	P 2
1.4	29H	71H	80N	30H	60H	25H	55H	35T	65T	30T	30T	25O	15O	20O	P 3
1.5	20I	49I	55O	40I	40I	35I	35I	45U	45U	20N	20N	20N	10N	15N	P 4
1.6	9I	21I	25O	20I	20I	15I	15I	20U	20U	15N	15N	15N	10N	10N	H 1
1.7															H 3
1.8															H 4
2.1	22L	43L	50R	25L	35L	20L	30L	25Y	35Y	25Y	25Y	20M	15M	15M	M 1
2.2	19L	36L	40R									15M	10M	10M	M 3
2.3	12L	23L	25R	20L	20L	15L	15L	20Y	20Y			10M	10M	10M	M 2
2.4															S 2
3.1	27G	55G	60M	30G	45G	25G	40G	30S	50S	30S	30S	20P	20P	25P	K 1
3.2	22G	45G	50M	25G	35G	20G	35G	25S	40S	25S	25S	20P	20P	20P	K 2
3.3	39H	79H	90N	40H	65H	35H	55H	45T	70T	40T	40T	30O	20O	30O	K 3
3.4	24H	49H	55N	25H	40H	20H	35H	30T	45T	25T	25T	20O	10O	20O	K 4
4.1	27J	41J	45P	30J	35J	25J	30J	30V	40V	30V	30V	30P	20P	35P	S 1
4.2	22J	34J	35P	25J	30J	20J	25J	25V	30V	25V	25V	20P	15P	20P	S 2
4.3	10J	15J	15P	10J	10J	10J	10J	14V	14V	10V	10V	10O	5O	10O	S 3
5.1	47J	114J	130P	50J	95J	45J	85J	50V	105V	50V	50V	35P	25P	35P	S 1
5.2	12I	24I	30O	15I	20I	10I	15I	15U	20V	15U	15U	10O	5O	5O	S 2
5.3	5J	10J	10P	10J	10J	10J	10J	10V	10V	10V	10V	5N	5N	5N	S 3
6.1				70I	140I	65I	125I	85U	170U	80U	80U	100Q	50Q	30Q	N 3
6.2	89I	170I	190O	70I	140I	65I	125I	85U	170U	80U	80U	100P	55P	35P	N 4
6.3				70I	140I	65I	125I	85U	170U	80U	80U	80U	35P	35P	N 3
6.4	12I	23I	25O	20I	20I	15I	15I	25V	25V	15O	15O	5O	5O	10O	N 4
7.1				180K	360K	160K	325K	220X	435X	200X	200X	250R	60R	70R	N 1
7.2				70K	140K	65K	125K	85X	170X	80X	80X	250R	50R	70R	N 1
7.3				70K	140K	65K	125K	85X	170X	80X	80X	65R	30R	30R	N 1
7.4	35G	35G	95M	70G	70G	65G	65G	85S	85S	45Q	45Q	45Q	20Q	20Q	N 2
8.1				70I	145I	65I	130I	90U	175U	80U	80U	100R	50R	35R	O
8.2															O
8.3															O
9.1															H
10.1												45Q	20Q	20Q	O

	HSS-E	HSS-E	HSS	HSS	HSS	HSS-E	HSS-E	HSS	HSS-E
	NF	N	N	N	N	N	N	N	N
	Z 6-8	Z 6-12	Z 6-12	Z 6-8	Z 6-8	Z 10-12	Z 10-12	Z 4	Z 4-8
	$\lambda 12^\circ$ $\gamma 10^\circ$	$\lambda 10^\circ$ $\gamma 10^\circ$	$\lambda 12^\circ$ $\gamma 10^\circ$	$\lambda 0^\circ$ $\gamma 0^\circ$	$\lambda 0^\circ$ $\gamma 0^\circ$	$\lambda 0^\circ$ $\gamma 0^\circ$	$\lambda 0^\circ$ $\gamma 0^\circ$	$\lambda 0^\circ$ $\gamma 0^\circ$	$\lambda 0^\circ$ $\gamma 0^\circ$
	DIN 1833E	DIN 1832E	DIN 1833D	DIN 1833D	DIN 1833D	DIN 1833E	DIN 1833E	DIN 1833D	DIN 1833E
	d11	h11				js16	js16		
	DIN 851	DIN 850	DIN 850	DIN 850	DIN 850	DIN 1833C	DIN 1833D	DIN 850	DIN 850
									
	C801	C822	C820	C837	C835	C830	C831	C710	C700
	16.00 - 32.00	4.50 - 45.50	10.50 - 45.50	13.00 - 1.1/2	1/2 - 1.1/2	12.00 - 32.00	12.00 - 32.00	1/16 - 1/2	1.00 - 20.00

AMG	442	443	444	446	447	448	449	450	451	ISO
1.1	■40P	■40P	■25P	■20P	■20P	■30P	■30P	■20P	■35P	P 1
1.2	■40P	■40P	■25P	■20P	■20P	■30P	■30P	■20P	■35P	P 1
1.3	■30O	■30O	■20O	■15O	■15O	■25O	■25O	■15O	■25O	P 2
1.4	■25O	■25O	■20O	■15O	■15O	■20O	■20O	■15O	■25O	P 3
1.5	■20N	■20N	■10N	■10N	■10N	■15N	■15N	■10N	■15N	P 4
1.6	■15N	■15N	■10N	■5N	■5N	■10N	■10N	■10N	■15N	H 1
1.7										H 3
1.8										H 4
2.1	■25M	■25M	■15M	■10M	■10M	■20M	■20M	■15M	■20M	M 1
2.2	■15M	■15M	■10M	■10M	■10M	■15M	■15M	■10M	■15M	M 3
2.3	■15M	■15M	■10M	■5M	■5M	■10M	■10M	■5M	■10M	M 2
2.4										S 2
3.1	■25P	■25P	■20P	■15P	■15P	■20P	■20P	■20P	■20P	K 1
3.2	■20P	■20P	■20P	■15P	■15P	■15P	■15P	■15P	■15P	K 2
3.3	■35O	■30O	■20O	■15O	■15O	■25O	■25O	■15O	■25O	K 3
3.4	■20O	■20O	■15O	■10O	■10O	■15O	■15O	■10O	■15O	K 4
4.1	■30P	■30P	■20P	■15P	■15P	■25P	■25P	■15P	■25P	S 1
4.2	■20P	■20P	■15P	■10P	■10P	■15P	■15P	■10P	■20P	S 2
4.3	■10O	■10O	■10O	■5O	■5O	■10O	■10O	■5O	■10O	S 3
5.1	■40P	■35P	■25P	■20P	■20P	■30P	■30P	■20P	■35P	S 1
5.2	■10O	■10O	■5O	■5O	■5O	■10O	■10O	■5O	■10O	S 2
5.3	■5N	■5N	■5N	■5N	■5N	■5N	■5N	■5N	■5N	S 3
6.1	■110Q	■100Q	■50Q	■40Q	■40Q	■90Q	■90Q	■40Q	■90Q	N 3
6.2	■110P	■100P	■55P	■45P	■45P	■90P	■90P	■45P	■90P	N 4
6.3	■40P	■100P	■55P	■15P	■15P	■75P	■75P	■45P	■90P	N 3
6.4	■15O	■15O	■5O	■5O	■5O	■10O	■10O	■5O	■15O	N 4
7.1	■275R	■260R	■65R	■50R	■50R	■190R	■190R	■55R	■245R	N 1
7.2	■275R	■260R	■50R	■40R	■40R	■190R	■190R	■40R	■230R	N 1
7.3	■70R	■68R	■35R	■25R	■25R	■55R	■55R	■25R	■60R	N 1
7.4	■45Q	■44Q	■20Q	■17Q	■17Q	■35Q	■35Q	■15Q	■40Q	N 2
8.1	■110R	■100R	■50R	■40R	■40R	■75R	■75R			O
8.2										O
8.3										O
9.1										H
10.1	■45Q	■45Q	■20Q			■35Q	■35Q	■15Q	■40Q	O

	HSS-E	HSS-E	HSS	HSS	HSS	HSS	HSS	HSS	
	Z 16-30	Z 28-44	Z 28-100	Z 40-200	Z 80-180	Z 100-140	Z 128-220	Z 160-350	
	$\gamma 15^\circ$ $\gamma 10^\circ$	$\gamma 15^\circ$ $\gamma 10^\circ$	$\gamma 15^\circ$	$\gamma 5^\circ$	$\gamma 18^\circ$	$\gamma 18^\circ$	$\gamma 18^\circ$	$\gamma 18^\circ$	
	DIN 885A	DIN 885A	DIN 1838	DIN 1837	EXTRAPOWER	EXTRAPOWER	EXTRAPOWER	EXTRAPOWER	
	D200	D763	D745	D747	D752	D753	D750	D751	
	50.00 - 200.00	63.00 - 125.00	50.00 - 315.00	32.00 - 315.00	200.00 - 350.00	250.00 - 350.00	200.00 - 350.00	200.00 - 350.00	
AMG	452	452	454	456	459	459	460	460	ISO
1.1	■45P	■45P	■40R	■40R	■40R	■40R	■40R	■40R	P 1
1.2	■40P	■40P	■30R	■30R	■30R	■30R	■30R	■30R	P 1
1.3	■35P	■35P	■30R	■30R	■30R	■30R	■30R	■30R	P 2
1.4	■30P	■30P	■20S	■20S	■20S	■20S	■20S	■20S	P 3
1.5	■20P	■20P							P 4
1.6	■10P	■10P							H 1
1.7									H 3
1.8									H 4
2.1	■30P	■30P	●10S	●10S	●10S	●10S	●10S	●10S	M 1
2.2	■20P	■20P	●10S	●10S	●10S	●10S	●10S	●10S	M 3
2.3	■10Q	■10Q							M 2
2.4									S 2
3.1	■30Q	■30Q	■40R	■40R	■40R	■40R	■40R	■40R	K 1
3.2	■25Q	■25Q	■40R	■40R	■40R	■40R	■40R	■40R	K 2
3.3	■40Q	■40Q	■30R	■30R	■30R	■30R	■30R	■30R	K 3
3.4	■25Q	■25Q							K 4
4.1	■30N	■30N							S 1
4.2	■20O	■20O							S 2
4.3	■15O	■15O							S 3
5.1	■40P	■40P							S 1
5.2	■15O	■15O							S 2
5.3	■10M	■10M							S 3
6.1	■150P	■150P	■200R	■200R	■200R	■200R	■200R	■200R	N 3
6.2	■150P	■150P	■200T	■200T	■200T	■200T	■200T	■200T	N 4
6.3	■150P	■150P	■200T	■200T	■200T	■200T	■200T	■200T	N 3
6.4	■15M	■15M							N 4
7.1	■400Q	■400Q	■600T	■600T	■600T	■600T	■600T	■600T	N 1
7.2	■400Q	■400Q	■500T	■500T	■500T	■500T	■500T	■500T	N 1
7.3	■100Q	■100Q	■500T	■500T	■500T	■500T	■500T	■500T	N 1
7.4	■70Q	■70Q							N 2
8.1	■150M	■150M	■60T	■60T	■60T	■60T	■60T	■60T	O
8.2									O
8.3									O
9.1									H
10.1									O

HSS-E	HSS-E	HSS-E	HSS-E
N	N	NR	NR
Z 8-12	Z 8-12	Z 6-10	Z 6-10
$\lambda 30^\circ$ $\gamma 12^\circ$	$\lambda 30^\circ$ $\gamma 12^\circ$	$\lambda 30^\circ$ $\gamma 12^\circ$	$\lambda 30^\circ$ $\gamma 12^\circ$
js16	js16	js16	js16
DIN 1880	DIN 1880	DIN 1880	DIN 1880
D400	D420	D402	D422
40.00 - 100.00	40.00 - 100.00	40.00 - 100.00	40.00 - 100.00

AMG	461	461	462	462	ISO
1.1	■40J	■75J	■40J	■75J	P 1
1.2	■40J	■75J	■40J	■75J	P 1
1.3	■30I	■65I	■30I	■65I	P 2
1.4	■25I	■50I	■25I	■50I	P 3
1.5	■20H	■35H	■20H	■35H	P 4
1.6	■15H	■30H	■15H	■30H	H 1
1.7					H 3
1.8					H 4
2.1	■25H	■35H	■25H	■35H	M 1
2.2	■15G	■30G	■15G	■30G	M 3
2.3	■10G	■20G	■10G	■20G	M 2
2.4					S 2
3.1	■20J	■35J	■20J	■35J	K 1
3.2	■20J	■30J	■20J	■30J	K 2
3.3	■30I	■50I	■30I	■50I	K 3
3.4	■20I	■30I	■20I	■30I	K 4
4.1	■30J	■35J	■30J	■35J	S 1
4.2	■20I	■25I	■20I	■25I	S 2
4.3	■10I	■15I	■10I	■15I	S 3
5.1	■35J	■75J	■35J	■75J	S 1
5.2	■10I	■20I	■10I	■20I	S 2
5.3	■5H	■10H	■5H	■10H	S 3
6.1	■105M	■150M	■105M	■150M	N 3
6.2	■105K	■150K	■105K	■150K	N 4
6.3	■35K	■50K	■35K	■50K	N 3
6.4	■15H	■20H	■15H	■20H	N 4
7.1	■260N	■260N	■260N	■260N	N 1
7.2	■260N	■260N	■260N	■260N	N 1
7.3	■65N	■135N	■65N	■135N	N 1
7.4	■45L	■75L	■45L	■75L	N 2
8.1	■105N	■120N	■105N	■120N	O
8.2	■30N	■60N	■30N	■60N	O
8.3	■5L	■15L	■5L	■15L	O
9.1					H
10.1	■45K	■125K	■45K	■125K	O

HM

Z Z Z Z Z Ae Ap
1 2 3 4 >4 (x Ø) (x Ø)



ø [mm] fz [mm/Z] ± 25%

Ø	1	2	3	4	5	6	8	10	12	14	16	18	20
A	0.012	0.024	0.035	0.045	0.055	0.065	0.080	0.093	0.107	0.121	0.134	0.149	0.162
B	0.016	0.032	0.047	0.061	0.074	0.087	0.107	0.124	0.143	0.162	0.179	0.198	0.216
C	0.020	0.040	0.058	0.076	0.092	0.108	0.134	0.156	0.179	0.202	0.224	0.248	0.271
D	0.024	0.048	0.070	0.091	0.111	0.130	0.160	0.187	0.214	0.242	0.268	0.297	0.325
E	0.028	0.056	0.081	0.106	0.129	0.152	0.187	0.218	0.250	0.283	0.313	0.347	0.379
F	0.032	0.064	0.093	0.121	0.148	0.173	0.214	0.249	0.286	0.323	0.358	0.396	0.433
G	0.037	0.071	0.105	0.136	0.166	0.195	0.240	0.280	0.321	0.364	0.403	0.446	0.487
H	0.041	0.079	0.116	0.152	0.185	0.216	0.267	0.311	0.357	0.404	0.447	0.495	0.541



A	0.010	0.019	0.028	0.036	0.044	0.052	0.064	0.074	0.085	0.096	0.107	0.118	0.129
B	0.013	0.025	0.037	0.048	0.059	0.069	0.085	0.099	0.114	0.128	0.142	0.157	0.172
C	0.016	0.032	0.046	0.060	0.073	0.086	0.106	0.124	0.142	0.161	0.178	0.197	0.215
D	0.019	0.038	0.055	0.072	0.088	0.103	0.127	0.148	0.170	0.193	0.213	0.236	0.258
E	0.023	0.044	0.065	0.084	0.103	0.120	0.149	0.173	0.199	0.225	0.249	0.276	0.301
F	0.026	0.050	0.074	0.096	0.118	0.138	0.170	0.198	0.227	0.257	0.284	0.315	0.344
G	0.029	0.057	0.083	0.108	0.132	0.155	0.191	0.223	0.256	0.289	0.320	0.354	0.387
H	0.032	0.063	0.092	0.120	0.147	0.172	0.212	0.247	0.284	0.321	0.356	0.394	0.430



A	0.007	0.014	0.021	0.027	0.033	0.038	0.047	0.055	0.063	0.071	0.079	0.087	0.095
B	0.010	0.019	0.027	0.036	0.043	0.051	0.063	0.073	0.084	0.095	0.105	0.116	0.127
C	0.012	0.023	0.034	0.045	0.054	0.064	0.078	0.091	0.105	0.119	0.132	0.146	0.159
D	0.014	0.028	0.041	0.053	0.065	0.076	0.094	0.110	0.126	0.143	0.158	0.175	0.191
E	0.017	0.033	0.048	0.062	0.076	0.089	0.110	0.128	0.147	0.166	0.184	0.204	0.223
F	0.019	0.037	0.055	0.071	0.087	0.102	0.126	0.146	0.168	0.190	0.210	0.233	0.255
G	0.021	0.042	0.062	0.080	0.098	0.115	0.141	0.165	0.189	0.214	0.237	0.262	0.286
H	0.024	0.047	0.068	0.089	0.109	0.127	0.157	0.183	0.210	0.238	0.263	0.291	0.318



A	0.005	0.010	0.015	0.019	0.024	0.028	0.034	0.040	0.046	0.052	0.058	0.064	0.070
B	0.007	0.014	0.020	0.026	0.032	0.037	0.046	0.053	0.061	0.069	0.077	0.085	0.093
C	0.009	0.017	0.025	0.032	0.040	0.046	0.057	0.067	0.077	0.087	0.096	0.106	0.116
D	0.010	0.020	0.030	0.039	0.048	0.056	0.069	0.080	0.092	0.104	0.115	0.127	0.139
E	0.012	0.024	0.035	0.045	0.055	0.065	0.080	0.093	0.107	0.121	0.134	0.149	0.162
F	0.014	0.027	0.040	0.052	0.063	0.074	0.092	0.107	0.122	0.138	0.153	0.170	0.185
G	0.016	0.031	0.045	0.058	0.071	0.083	0.103	0.120	0.138	0.156	0.173	0.191	0.209
H	0.017	0.034	0.050	0.065	0.079	0.093	0.114	0.133	0.153	0.173	0.192	0.212	0.232





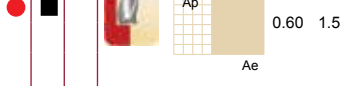



A	0.004	0.008	0.011	0.015	0.018	0.021	0.026	0.031	0.035	0.040	0.044	0.049	0.053
B	0.005	0.010	0.015	0.020	0.024	0.028	0.035	0.041	0.047	0.053	0.059	0.065	0.071
C	0.007	0.013	0.019	0.025	0.030	0.035	0.044	0.051	0.058	0.066	0.073	0.081	0.089
D	0.008	0.016	0.023	0.030	0.036	0.043	0.052	0.061	0.070	0.079	0.088	0.097	0.106
E	0.009	0.018	0.027	0.035	0.042	0.050	0.061	0.071	0.082	0.093	0.103	0.114	0.124
F	0.011	0.021	0.030	0.040	0.048	0.057	0.070	0.082	0.094	0.106	0.117	0.130	0.142
G	0.012	0.023	0.034	0.045	0.054	0.064	0.079	0.092	0.105	0.119	0.132	0.146	0.159
H	0.013	0.026	0.038	0.050	0.061	0.071	0.087	0.102	0.117	0.132	0.146	0.162	0.177

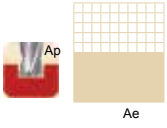

优异
 Excelente
 Excelente
 Excellent

良好
 Bom
 Bueno
 Good

HM

Z	Z	Z	Z	Z	Ae	Ap	 ∅ [mm] fz [mm/Z] ± 25%															
1	2	3	4	>4	(x ∅)	(x ∅)		∅	1	2	3	4	5	6	8	10	12	14	16	18	20	
		1.0 0.5	A	0.003	0.006	0.009	0.012	0.014	0.017	0.021	0.024	0.028	0.032	0.035	0.039	0.042						
			B	0.004	0.008	0.012	0.016	0.019	0.023	0.028	0.033	0.037	0.042	0.047	0.052	0.057						
			C	0.005	0.010	0.015	0.020	0.024	0.028	0.035	0.041	0.047	0.053	0.058	0.065	0.071						
			D	0.006	0.012	0.018	0.024	0.029	0.034	0.042	0.049	0.056	0.063	0.070	0.078	0.085						
			E	0.007	0.015	0.021	0.028	0.034	0.040	0.049	0.057	0.065	0.074	0.082	0.091	0.099						
			F	0.008	0.017	0.024	0.032	0.039	0.045	0.056	0.065	0.075	0.084	0.093	0.103	0.113						
			G	0.010	0.019	0.027	0.036	0.043	0.051	0.063	0.073	0.084	0.095	0.105	0.116	0.127						
			H	0.011	0.021	0.030	0.040	0.048	0.057	0.070	0.081	0.093	0.106	0.117	0.129	0.141						
					1.0 1.0	A	0.003	0.005	0.007	0.010	0.012	0.014	0.017	0.020	0.022	0.025	0.028	0.031	0.034			
B	0.003	0.007				0.010	0.013	0.015	0.018	0.022	0.026	0.030	0.034	0.037	0.041	0.045						
C	0.004	0.008				0.012	0.016	0.019	0.023	0.028	0.033	0.037	0.042	0.047	0.052	0.057						
D	0.005	0.010				0.015	0.019	0.023	0.027	0.033	0.039	0.045	0.051	0.056	0.062	0.068						
E	0.006	0.012				0.017	0.022	0.027	0.032	0.039	0.046	0.052	0.059	0.065	0.072	0.079						
F	0.007	0.013				0.019	0.025	0.031	0.036	0.045	0.052	0.060	0.068	0.075	0.083	0.090						
G	0.008	0.015				0.022	0.029	0.035	0.041	0.050	0.059	0.067	0.076	0.084	0.093	0.102						
H	0.008	0.017				0.024	0.032	0.039	0.045	0.056	0.065	0.075	0.084	0.093	0.103	0.113						
		0.10 0.05				A	0.004	0.008	0.012	0.016	0.020	0.023	0.029	0.033	0.038	0.043	0.048	0.053	0.058			
			B	0.006	0.011	0.017	0.022	0.026	0.031	0.038	0.044	0.051	0.058	0.064	0.071	0.077						
			C	0.007	0.014	0.021	0.027	0.033	0.039	0.048	0.056	0.064	0.072	0.080	0.088	0.097						
			D	0.009	0.017	0.025	0.032	0.040	0.046	0.057	0.067	0.076	0.086	0.096	0.106	0.116						
			E	0.010	0.020	0.029	0.038	0.046	0.054	0.067	0.078	0.089	0.101	0.112	0.124	0.135						
			F	0.012	0.023	0.033	0.043	0.053	0.062	0.076	0.089	0.102	0.115	0.128	0.141	0.154						
			G	0.013	0.025	0.037	0.049	0.059	0.069	0.086	0.100	0.115	0.130	0.144	0.159	0.174						
			H	0.014	0.028	0.042	0.054	0.066	0.077	0.095	0.111	0.127	0.144	0.160	0.177	0.193						

 优异
 Excelente
 Excelente
 Excellent

 良好
 Bom
 Bueno
 Good

HSS HSS-E HSS-E PM

Z	Z	Z	Z	Ø	Ae (x Ø)	Ap (x Ø)	fz	Ø [mm] fz [mm/Z] ± 25%																							
2	3	4	>4					Ø	1	2	3	4	5	6	8	10	12	14	16	18	20	22	25	28	30	32	36	40	50		
■ ●			0.2 - 0.5	A	0.004	0.008	0.013	0.017	0.024	0.029	0.043	0.060	0.072	0.084	0.096	0.097	0.096	0.099	0.105	0.109	0.108	0.106	0.108	0.108	0.105						
				B	0.004	0.007	0.012	0.015	0.022	0.026	0.039	0.054	0.065	0.076	0.086	0.087	0.086	0.089	0.095	0.098	0.097	0.095	0.097	0.097	0.095	0.097	0.097	0.095			
				C	0.003	0.006	0.011	0.014	0.019	0.023	0.035	0.049	0.058	0.068	0.078	0.079	0.078	0.080	0.085	0.088	0.087	0.086	0.087	0.087	0.086	0.087	0.087	0.085	0.087	0.087	0.085
				D	0.004	0.007	0.011	0.014	0.020	0.024	0.037	0.051	0.061	0.071	0.081	0.082	0.081	0.084	0.089	0.099	0.091	0.097	0.091	0.101	0.101	0.091	0.101	0.101	0.091	0.101	0.101
				E	0.007	0.012	0.018	0.024	0.035	0.042	0.063	0.087	0.105	0.122	0.140	0.141	0.140	0.144	0.153	0.171	0.157	0.168	0.157	0.175	0.175	0.157	0.175	0.175	0.157	0.175	0.175
				F	0.007	0.009	0.013	0.018	0.021	0.025	0.033	0.041	0.050	0.055	0.064	0.072	0.079	0.079	0.085	0.085	0.085	0.085	0.085	0.085	0.085	0.085	0.085	0.085	0.085	0.085	0.085
■ ■ ■			0.05 - 1.0 - 0.15 - 2.0	G						0.026	0.034	0.036	0.043	0.050	0.057	0.064	0.071	0.071	0.054	0.053	0.054	0.053	0.056	0.057	0.060						
				H						0.023	0.031	0.032	0.039	0.045	0.051	0.058	0.064	0.064	0.049	0.048	0.049	0.048	0.048	0.050	0.051	0.054					
				I						0.021	0.028	0.029	0.035	0.041	0.046	0.052	0.058	0.058	0.044	0.043	0.044	0.043	0.043	0.045	0.046	0.049					
				J						0.024	0.031	0.033	0.039	0.046	0.052	0.059	0.065	0.065	0.049	0.049	0.049	0.049	0.049	0.051	0.052	0.055					
				K						0.035	0.047	0.065	0.079	0.092	0.105	0.088	0.098	0.097	0.110	0.110	0.110	0.110	0.110	0.110	0.110	0.110	0.110	0.110	0.110	0.110	0.110
				L						0.010	0.013	0.017	0.020	0.025	0.028	0.030	0.032	0.033	0.034	0.036	0.038	0.039	0.040	0.042	0.042	0.042	0.042	0.042	0.042	0.042	0.042
■ ■ ●			0.15 - 1.0 - 0.30 - 1.5	M	0.008	0.012	0.018	0.023	0.031	0.041	0.057	0.069	0.080	0.091	0.103	0.114	0.090	0.103	0.085	0.091	0.097	0.110	0.107	0.086							
				N	0.007	0.011	0.016	0.021	0.028	0.037	0.051	0.062	0.072	0.082	0.093	0.103	0.081	0.093	0.077	0.082	0.087	0.099	0.096	0.077							
				O	0.006	0.010	0.015	0.019	0.025	0.033	0.046	0.056	0.065	0.074	0.083	0.092	0.073	0.083	0.069	0.074	0.079	0.089	0.087	0.070							
				P	0.007	0.010	0.016	0.020	0.027	0.035	0.049	0.059	0.069	0.079	0.088	0.098	0.078	0.088	0.073	0.079	0.084	0.094	0.092	0.074							
				Q	0.009	0.014	0.021	0.026	0.036	0.048	0.066	0.079	0.092	0.106	0.089	0.099	0.098	0.111	0.111	0.119	0.127	0.143	0.139	0.148							
				R	0.012	0.016	0.020	0.025	0.029	0.038	0.047	0.056	0.065	0.073	0.083	0.092	0.092	0.092	0.092	0.092	0.092	0.104	0.104	0.108	0.108						
■			0.3 - 0.5 - 0.8 - 1.5	S	0.010	0.015	0.023	0.029	0.039	0.051	0.071	0.086	0.100	0.114	0.129	0.143	0.113	0.129	0.107	0.114	0.122	0.137	0.133	0.107							
				T	0.009	0.014	0.021	0.026	0.035	0.046	0.064	0.077	0.090	0.103	0.116	0.129	0.102	0.116	0.096	0.103	0.110	0.123	0.120	0.096							
				U	0.008	0.012	0.019	0.023	0.032	0.041	0.058	0.070	0.081	0.092	0.104	0.116	0.092	0.104	0.087	0.092	0.099	0.111	0.108	0.087							
				V	0.009	0.013	0.020	0.025	0.033	0.044	0.061	0.074	0.086	0.098	0.110	0.123	0.097	0.110	0.092	0.098	0.105	0.118	0.115	0.092							
				X	0.012	0.017	0.026	0.033	0.045	0.059	0.082	0.099	0.115	0.132	0.111	0.124	0.122	0.139	0.139	0.148	0.158	0.178	0.173	0.186							
				Y	0.015	0.020	0.025	0.031	0.036	0.047	0.059	0.070	0.081	0.092	0.104	0.115	0.115	0.115	0.115	0.115	0.115	0.130	0.130	0.136	0.136						

■ 优异
 Excelente
 Excelente
 Excellent

● 良好
 Bom
 Bueno
 Good

HSS HSS-E HSS-E PM

Ø	fz	Ø [mm] fz [mm/Z] ± 25%																
		10	12	16	20	25	32	38	50	63	80	100	125	160	200	300	350	
C800 C801 C810 C820 C822 C825		M	0.017	0.022	0.036	0.038	0.041	0.044	0.045	0.047								
	N	0.022	0.027	0.045	0.046	0.052	0.058	0.06	0.062									
	O	0.025	0.03	0.052	0.055	0.056	0.058	0.06	0.062									
	P	0.030	0.043	0.063	0.064	0.062	0.068	0.07	0.072									
	Q	0.045	0.048	0.063	0.064	0.066	0.068	0.07	0.072									
	R	0.055	0.07	0.115	0.119	0.123	0.126	0.128	0.13									
C830 C835 C837 C831		M	0.036	0.045	0.057	0.064	0.074	0.084										
	N	0.048	0.058	0.073	0.084	0.095	0.105											
	O	0.052	0.063	0.081	0.092	0.103	0.114											
	P	0.059	0.071	0.089	0.1	0.112	0.125											
	Q	0.072	0.088	0.106	0.12	0.133	0.147											
	R	0.079	0.095	0.114	0.13	0.143	0.157											
C700 C710		M	0.03	0.03	0.03	0.04	0.05	0.05										
	N	0.04	0.04	0.04	0.05	0.06	0.07											
	O	0.04	0.04	0.05	0.06	0.07	0.08											
	P	0.04	0.04	0.05	0.07	0.08	0.08											
	Q	0.05	0.05	0.07	0.08	0.09	0.10											
	R	0.06	0.06	0.07	0.09	0.10	0.11											
D745 D747 D750 D751 D752 D753		R				0.040	0.040	0.040	0.040	0.040	0.040	0.040	0.040	0.040	0.040	0.040	0.040	
	S					0.020	0.020	0.020	0.020	0.020	0.020	0.020	0.020	0.020	0.020	0.020	0.020	
	T					0.060	0.060	0.060	0.060	0.060	0.060	0.060	0.060	0.060	0.060	0.060	0.060	
D200 D263	 Ap = 0.1 X Ø	M					0.040	0.050	0.060	0.070	0.080	0.090	0.100	0.105	0.115			
		N						0.060	0.070	0.080	0.090	0.100	0.105	0.115				
		O						0.070	0.080	0.090	0.100	0.105	0.110	0.120				
		P						0.080	0.090	0.095	0.110	0.115	0.115	0.125				
		Q						0.090	0.100	0.105	0.110	0.115	0.125	0.135				
D402 D422	 Ae = 0.75 x Ø Ap = 0.25 x Ø	G	0.042	0.049	0.040	0.047	0.040	0.037										
		H	0.050	0.059	0.047	0.055	0.048	0.044										
		I	0.062	0.071	0.058	0.066	0.058	0.054										
		J	0.082	0.095	0.078	0.090	0.078	0.073										
		K	0.118	0.140	0.110	0.130	0.110	0.103										
		L	0.145	0.171	0.136	0.160	0.136	0.127										
		M	0.185	0.160	0.170	0.200	0.170	0.160										
		N	0.270	0.320	0.250	0.290	0.250	0.230										
D400 D420	 Ae = 0.75 x Ø Ap = 0.1 x Ø	G	0.042	0.049	0.040	0.047	0.040											
		H	0.050	0.059	0.047	0.055	0.048											
		I	0.062	0.071	0.058	0.066	0.058											
		J	0.082	0.095	0.078	0.090	0.078											
		K	0.118	0.140	0.110	0.130	0.110											
		L	0.145	0.171	0.136	0.160	0.136											
		M	0.185	0.160	0.170	0.200	0.170											
		N	0.270	0.320	0.250	0.290	0.250											

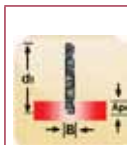

D750
D751
D752
D753

齿数的选择
Tabela de Passo por Dentes
Tabla de Paso por Dientes
Tooth Pitch Choice

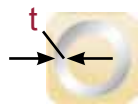

t (mm)



Ø (mm)

	<1.0 mm	1.0 - 1.5 mm	1.5 - 2.0 mm	2.0 - 3.0 mm	3.0 - 4.0 mm	>4.0 mm	10 - 20 mm	20 - 40 mm	40 - 60 mm	
1.1	3	4	5	5	6	7	5	8		P 1
1.2	3	4	4	5	6	7	5	6		P 1
1.3	3	4	4	5	6	7	5	6		P 2
1.4	3	4	4	5	6	7	5	6		P 3
1.5	3	3	4	5	5	6	5	6	8	P 4
1.6										H 1
1.7										H 3
1.8										H 4
2.1	3	4	5	5	6	6	5	6	8	M 1
2.2	3	4	5	5	6	6	5	6	8	M 3
2.3	3	4	5	5	6	6	5	6	8	M 2
2.4	3	4	5	5	6	6	5	6	8	S 2
3.1							6	8		K 1
3.2							6	8		K 2
3.3							6	8		K 3
3.4							6	8		K 4
4.1										S 1
4.2										S 2
4.3										S 3
5.1										S 1
5.2										S 2
5.3										S 3
6.1	4	5	6	7	8	8	6	8		N 3
6.2	4	5	6	7	8	8	8			N 4
6.3	4	5	6	7	8	8	8			N 3
6.4	4	5	6	7	8	8	6	8		N 4
7.1	4	5	6	7	8	8	6	8		N 1
7.2	4	5	6	7	8	8	6	8		N 1
7.3	4	5	6	7	8	8	6	8		N 1
7.4	4	5	6	7	8	8	6	8		N 2
8.1										O
8.2										O
8.3										O
9.1										H
10.1										O

	管件 Tubo oco Tubo hueco Hollow tube		实体材料 Barra maciça Sección maciza Solid section
--	---	--	---



- S802HA**
- 钻铣刀
 - Fresa de topo para canales
- S802HB**
- Fresas Frontales
 - Slot Drill

S802HA; S802HB	▪	1.1	1.2	1.3	1.4	1.5	1.6	2.1	2.2	3.1	3.2	3.3	3.4	6.2	6.3	6.4	7.2	7.3	7.4
	•	2.3	2.4	4.1	4.2	5.1	5.2	6.1	7.1	8.1	8.2								



d ₁ ∅ mm	d ₂ ∅h ₆ mm	l ₂ mm	l ₁ mm	z	S802HA	S802HB
1.00	3	3	38	2	S802HA1.0	
1.50	3	3	38	2	S802HA1.5	
1.80	6	3	50	2	S802HA1.8	S802HB1.8
2.00	6	3	50	2	S802HA2.0	S802HB2.0
2.50	6	3	50	2	S802HA2.5	S802HB2.5
2.80	6	4	50	2	S802HA2.8	S802HB2.8
3.00	6	4	50	2	S802HA3.0	S802HB3.0
3.50	6	4	50	2	S802HA3.5	S802HB3.5
3.80	6	5	54	2	S802HA3.8	S802HB3.8
4.00	6	5	54	2	S802HA4.0	S802HB4.0
4.50	6	5	54	2	S802HA4.5	S802HB4.5
4.80	6	6	54	2	S802HA4.8	S802HB4.8
5.00	6	6	54	2	S802HA5.0	S802HB5.0
5.75	6	7	54	2	S802HA5.75	S802HB5.75
6.00	6	7	54	2	S802HA6.0	S802HB6.0
6.75	8	8	58	2	S802HA6.75	S802HB6.75
7.00	8	8	58	2	S802HA7.0	S802HB7.0
7.75	8	9	58	2	S802HA7.75	S802HB7.75
8.00	8	9	58	2	S802HA8.0	S802HB8.0
9.00	10	10	66	2	S802HA9.0	S802HB9.0
9.70	10	11	66	2	S802HA9.7	S802HB9.7
10.00	10	11	66	2	S802HA10.0	S802HB10.0
11.70	12	12	73	2	S802HA11.7	S802HB11.7
12.00	12	12	73	2	S802HA12.0	S802HB12.0
13.70	14	14	75	2	S802HA13.7	S802HB13.7
14.00	14	14	75	2	S802HA14.0	S802HB14.0
15.70	16	16	82	2	S802HA15.7	S802HB15.7
16.00	16	16	82	2	S802HA16.0	S802HB16.0
17.70	18	18	84	2	S802HA17.7	S802HB17.7
18.00	18	18	84	2	S802HA18.0	S802HB18.0
19.70	20	20	92	2	S802HA19.7	S802HB19.7
20.00	20	20	92	2	S802HA20.0	S802HB20.0



- S812HA**
- 钻铣刀
 - Fresa de topo para canales
- S812HB**
- Fresas Frontales
 - Slot Drill

S812HA; S812HB	1.1	1.2	1.3	1.4	1.5	1.6	2.1	2.2	2.3	3.1	3.2	3.3	3.4	4.1	4.2	5.1	5.2
	6.1	6.2	6.3	6.4	7.1	7.2	7.3	7.4	8.1	8.2							



d_1 Ø mm	d_2 Ø _{h6} mm	l_2 mm	l_1 mm	z	S812HA	S812HB
2.00	6	6	57	2	S812HA2.0	S812HB2.0
2.50	6	7	57	2	S812HA2.5	S812HB2.5
3.00	6	7	57	2	S812HA3.0	S812HB3.0
3.50	6	7	57	2	S812HA3.5	S812HB3.5
4.00	6	8	57	2	S812HA4.0	S812HB4.0
4.50	6	8	57	2	S812HA4.5	S812HB4.5
5.00	6	10	57	2	S812HA5.0	S812HB5.0
6.00	6	10	57	2	S812HA6.0	S812HB6.0
7.00	8	13	63	2	S812HA7.0	S812HB7.0
8.00	8	16	63	2	S812HA8.0	S812HB8.0
9.00	10	16	72	2	S812HA9.0	S812HB9.0
10.00	10	19	72	2	S812HA10.0	S812HB10.0
12.00	12	22	83	2	S812HA12.0	S812HB12.0
14.00	14	22	83	2	S812HA14.0	S812HB14.0
16.00	16	26	92	2	S812HA16.0	S812HB16.0
18.00	18	26	92	2	S812HA18.0	S812HB18.0
20.00	20	32	104	2	S812HA20.0	S812HB20.0



- S803HA**
- 钻铣刀
 - Fresa de topo para canales
- S803HB**
- Fresas Frontales
 - Slot Drill

S803HA; S803HB	▪	1.1	1.2	1.3	1.4	1.5	1.6	2.1	2.2	3.1	3.2	3.3	3.4	6.2	6.3	6.4	7.2	7.3	7.4		
	•	2.3	2.4	4.1	4.2	5.1	5.2	6.1	7.1	8.1	8.2										



d_1 Ø mm	d_2 Ø _{h6} mm	l_2 mm	l_1 mm	z	S803HA	S803HB
1.00	3	3	38	3	S803HA1.0	
1.50	3	3	38	3	S803HA1.5	
1.80	6	3	50	3	S803HA1.8	S803HB1.8
2.00	6	3	50	3	S803HA2.0	S803HB2.0
2.50	6	3	50	3	S803HA2.5	S803HB2.5
2.80	6	4	50	3	S803HA2.8	S803HB2.8
3.00	6	4	50	3	S803HA3.0	S803HB3.0
3.50	6	4	50	3	S803HA3.5	S803HB3.5
3.80	6	5	54	3	S803HA3.8	S803HB3.8
4.00	6	5	54	3	S803HA4.0	S803HB4.0
4.50	6	5	54	3	S803HA4.5	S803HB4.5
4.80	6	6	54	3	S803HA4.8	S803HB4.8
5.00	6	6	54	3	S803HA5.0	S803HB5.0
5.75	6	7	54	3	S803HA5.75	S803HB5.75
6.00	6	7	54	3	S803HA6.0	S803HB6.0
6.75	8	8	58	3	S803HA6.75	S803HB6.75
7.00	8	8	58	3	S803HA7.0	S803HB7.0
7.75	8	9	58	3	S803HA7.75	S803HB7.75
8.00	8	9	58	3	S803HA8.0	S803HB8.0
9.00	10	10	66	3	S803HA9.0	S803HB9.0
9.70	10	11	66	3	S803HA9.7	S803HB9.7
10.00	10	11	66	3	S803HA10.0	S803HB10.0
11.70	12	12	73	3	S803HA11.7	S803HB11.7
12.00	12	12	73	3	S803HA12.0	S803HB12.0
13.70	14	14	75	3	S803HA13.7	S803HB13.7
14.00	14	14	75	3	S803HA14.0	S803HB14.0
15.70	16	16	82	3	S803HA15.7	S803HB15.7
16.00	16	16	82	3	S803HA16.0	S803HB16.0
17.70	18	18	84	3	S803HA17.7	S803HB17.7
18.00	18	18	84	3	S803HA18.0	S803HB18.0
19.70	20	20	92	3	S803HA19.7	S803HB19.7
20.00	20	20	92	3	S803HA20.0	S803HB20.0

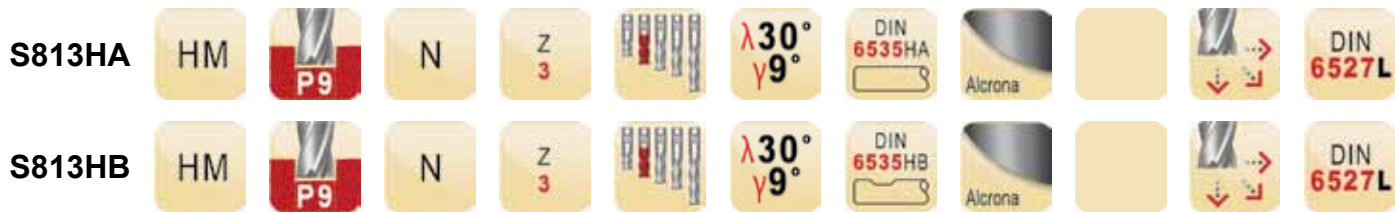

- S813HA** • 钻铣刀
• Fresa de topo para canales
- S813HB** • Fresas Frontales
• Slot Drill

S813HA; S813HB	▪	1.1	1.2	1.3	1.4	1.5	2.1	3.1	3.2	3.3	3.4	6.2	6.3	6.4	7.2	7.3	7.4
	•	1.6	2.2	2.3	4.1	4.2	5.1	5.2	6.1	7.1	8.1	8.2					



d_1 Ø mm	d_2 Ø _{h6} mm	l_2 mm	l_1 mm	z	S813HA	S813HB
2.00	6	6	57	3	S813HA2.0	S813HB2.0
2.50	6	7	57	3	S813HA2.5	S813HB2.5
3.00	6	7	57	3	S813HA3.0	S813HB3.0
3.50	6	7	57	3	S813HA3.5	S813HB3.5
4.00	6	8	57	3	S813HA4.0	S813HB4.0
4.50	6	8	57	3	S813HA4.5	S813HB4.5
5.00	6	10	57	3	S813HA5.0	S813HB5.0
6.00	6	10	57	3	S813HA6.0	S813HB6.0
7.00	8	13	63	3	S813HA7.0	S813HB7.0
8.00	8	16	63	3	S813HA8.0	S813HB8.0
9.00	10	16	72	3	S813HA9.0	S813HB9.0
10.00	10	19	72	3	S813HA10.0	S813HB10.0
12.00	12	22	83	3	S813HA12.0	S813HB12.0
14.00	14	22	83	3	S813HA14.0	S813HB14.0
16.00	16	26	92	3	S813HA16.0	S813HB16.0
18.00	18	26	92	3	S813HA18.0	S813HB18.0
20.00	20	32	104	3	S813HA20.0	S813HB20.0

S710



- 立铣刀
- Fresa de Topo
- Fresas de acabado
- End Mill

S710

S710 ■ 1.1 1.2 1.3 1.4 1.5 2.1 2.2 3.1 3.2 3.3 3.4 4.2 5.2



d_1 Ø mm	d_2 Ø _{h6} mm	l_2 mm	l_1 mm	z	S710
1.00	3	3	40	2	S7101.0
1.50	3	4.5	40	2	S7101.5
2.00	3	6.5	40	2	S7102.0
2.50	3	6.5	40	2	S7102.5
3.00	6	9	50	2	S7103.0
4.00	6	12	50	2	S7104.0
5.00	6	15	50	2	S7105.0
6.00	6	20	60	2	S7106.0
8.00	8	20	64	2	S7108.0
10.00	10	22	75	2	S71010.0
12.00	12	25	75	2	S71012.0
14.00	14	32	90	2	S71014.0
16.00	16	32	90	2	S71016.0
20.00	20	38	100	2	S71020.0



- S902**
- 立铣刀
 - Fresa de Topo
- S922**
- Fresas de acabado
 - End Mill

S902	▪	1.1	1.2	1.3	1.4	3.1	3.3	4.1	5.1	6.1	6.2	6.3			
	•	1.5	3.2	3.4	4.2	4.3	6.4	7.1	7.2	7.3	8.1	8.2	8.3		
S922	▪	1.1	1.2	1.3	1.4	1.5	3.1	3.2	3.3	3.4	4.1	5.1	6.1	6.2	6.3
	•	1.6	4.2	4.3	6.4	7.1	7.2	7.3	8.1	8.2	8.3				

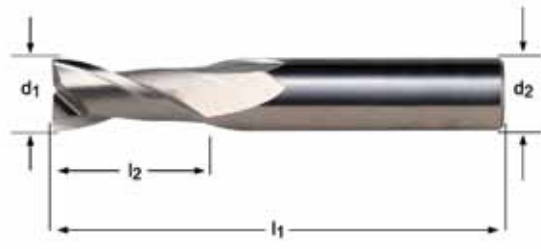

d ₁ Ø mm	d ₂ Øh ₆ mm	l ₂ mm	l ₁ mm	z	S902	S922
2.00	3	6	38	2	S9022.0	S9222.0 ¹⁾
2.50	3	9	38	2	S9022.5	S9222.5 ¹⁾
3.00	3	12	38	2	S9023.0	S9223.0 ¹⁾
4.00	4	14	50	2	S9024.0	S9224.0 ¹⁾
5.00	5	16	50	2	S9025.0	S9225.0 ¹⁾
6.00	6	19	57	2	S9026.0	S9226.0
7.00	8	19	63	2	S9027.0	S9227.0
8.00	8	19	63	2	S9028.0	S9228.0
9.00	10	21	72	2	S9029.0	S9229.0
10.00	10	22	72	2	S90210.0	S92210.0
12.00	12	25	73	2	S90212.0	S92212.0
14.00	14	30	83	2	S90214.0	S92214.0
16.00	16	32	92	2	S90216.0	S92216.0
18.00	18	32	92	2	S90218.0	S92218.0
20.00	20	38	104	2	S90220.0	S92220.0

¹⁾ 圆柱柄 / Haste cilíndrica / Mango cilíndrico / Cylindrical shank



- S903**
- 立铣刀
 - Fresa de Topo
- S933**
- Fresas de acabado
 - End Mill

S903	■	1.1	1.2	1.3	1.4	3.1	3.3	4.1	5.1	6.1	6.2	6.3			
	•	1.5	3.2	3.4	4.2	4.3	6.4	7.1	7.2	7.3	8.1	8.2	8.3		
S933	■	1.1	1.2	1.3	1.4	1.5	3.1	3.2	3.3	3.4	4.1	5.1	6.1	6.2	6.3
	•	1.6	4.2	4.3	6.4	7.1	7.2	7.3	8.1	8.2	8.3				

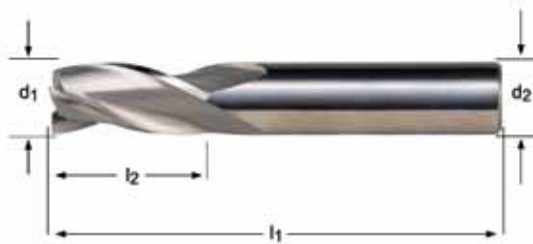

d ₁ Ø mm	d ₂ Øh ₆ mm	l ₂ mm	l ₁ mm	z	S903	S933
2.00	3	6	38	3	S9032.0	S9332.0 ¹⁾
2.50	3	9	38	3	S9032.5	S9332.5 ¹⁾
3.00	3	12	38	3	S9033.0	S9333.0 ¹⁾
4.00	4	14	50	3	S9034.0	S9334.0 ¹⁾
5.00	5	16	50	3	S9035.0	S9335.0 ¹⁾
6.00	6	19	57	3	S9036.0	S9336.0
7.00	8	19	63	3	S9037.0	S9337.0
8.00	8	19	63	3	S9038.0	S9338.0
9.00	10	21	72	3	S9039.0	S9339.0
10.00	10	22	72	3	S90310.0	S93310.0
12.00	12	25	73	3	S90312.0	S93312.0
14.00	14	30	83	3	S90314.0	S93314.0
16.00	16	32	92	3	S90316.0	S93316.0
18.00	18	32	92	3	S90318.0	S93318.0
20.00	20	38	104	3	S90320.0	S93320.0

¹⁾ 圆柱柄 / Haste cilíndrica / Mango cilíndrico / Cylindrical shank

S714



- 立铣刀
- Fresa de Topo
- Fresas de acabado
- End Mill

S714

S714	1.1	1.2	1.3	1.4	1.5	2.1	2.2	3.1	3.2	3.3	3.4	4.2	5.2	6.1	6.2	6.3	6.4	7.1	7.2	7.3	
	7.4																				

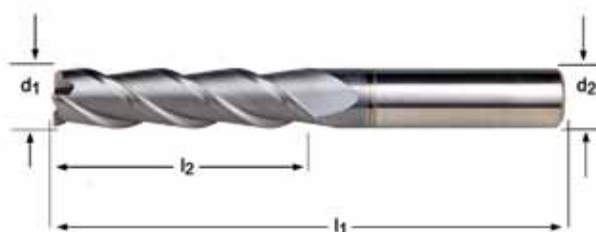

d_1 Ø mm	d_2 Ø _{h₆} mm	l_2 mm	l_1 mm	z	S714
3.00	3	19	60	3	S7143.0
4.00	4	19	60	3	S7144.0
5.00	5	19	60	3	S7145.0
6.00	6	31	75	3	S7146.0
8.00	8	31	75	3	S7148.0
10.00	10	31	75	3	S71410.0
12.00	12	50	100	3	S71412.0
14.00	14	57	125	3	S71414.0
16.00	16	57	125	3	S71416.0
18.00	18	57	125	3	S71418.0
20.00	20	57	125	3	S71420.0

S715



- 立铣刀
- Fresa de Topo
- Fresas de acabado
- End Mill

S715

S715 ■ 1.1 1.2 1.3 1.4 1.5 2.1 2.2 3.1 3.2 3.3 3.4 4.2 5.2



d_1 Ø mm	d_2 Ø _{h6} mm	l_2 mm	l_1 mm	z	S715
3.00	3	25	100	3	S7153.0
4.00	4	31	100	3	S7154.0
5.00	5	31	100	3	S7155.0
6.00	6	38	100	3	S7156.0
8.00	8	41	100	3	S7158.0
10.00	10	57	125	3	S71510.0
12.00	12	75	150	3	S71512.0
14.00	14	75	150	3	S71514.0
16.00	16	75	150	3	S71516.0
18.00	18	75	150	3	S71518.0
20.00	20	75	150	3	S71520.0

S637



- 立铣刀
- Fresa de Topo
- Fresas de acabado
- End Mill

S637

S637 ■ 6.1 6.2 6.3 6.4 7.1 7.2 7.3 7.4 8.1 8.2



d_1 Ø mm	d_2 Ø _{h_s} mm	l_2 mm	l_1 mm	z	S637
2.00	2	10	40	1	S6372.0
3.00	3	12	40	1	S6373.0
4.00	4	15	50	1	S6374.0
5.00	5	16	50	1	S6375.0
6.00	6	20	60	1	S6376.0
8.00	8	22	63	1	S6378.0
10.00	10	25	72	1	S63710.0
12.00	12	30	83	1	S63712.0

S638



S638

- 立铣刀
- Fresa de Topo
- Fresas de acabado
- End Mill

- 缩柄
- Haste reduzida
- Mango reducido
- Reduced shank

S638 ■ 6.1 6.2 6.3 6.4 7.1 7.2 7.3 7.4 8.1 8.2



d_1 Ø mm	d_2 Ø _{h6} mm	l_2 mm	l_1 mm	z	S638
6.20	6	8	100	2	S6386.2
8.20	8	10	100	2	S6388.2
10.30	10	14	125	2	S63810.3
12.30	12	16	125	2	S63812.3
16.30	16	20	125	2	S63816.3
20.30	20	25	125	2	S63820.3

S610



- 立铣刀
- Fresa de Topo
- Fresas de acabado
- End Mill

S610

S610 ■ 6.1 6.2 6.3 6.4 7.1 7.2 7.3 7.4 8.1 8.2



d_1 \varnothing mm	d_2 $\varnothing h_8$ mm	l_2 mm	l_1 mm	z	S610
3.00	3	9	40	2	S6103.0XD3
3.00	6	9	50	2	S6103.0XD6
4.00	4	12	50	2	S6104.0XD4
4.00	6	12	50	2	S6104.0XD6
5.00	6	15	50	2	S6105.0
6.00	6	20	60	2	S6106.0
8.00	8	20	64	2	S6108.0
10.00	10	22	70	2	S61010.0
12.00	12	25	75	2	S61012.0
14.00	14	32	90	2	S61014.0
16.00	16	32	90	2	S61016.0
20.00	20	38	100	2	S61020.0

S611



- 立铣刀
- Fresa de Topo
- Fresas de acabado
- End Mill

S611

S611 ■ 6.1 6.2 6.3 6.4 7.1 7.2 7.3 7.4 8.1 8.2

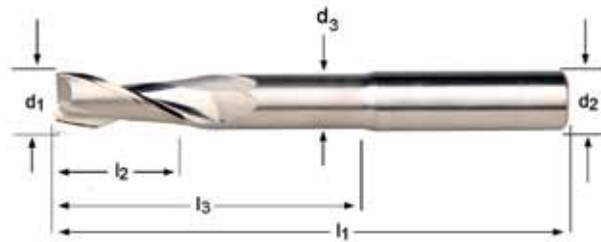

d_1 Ø mm	d_2 Ø _{h₆} mm	l_2 mm	l_1 mm	z	l_3 mm	d_3 Ø mm	S611
6.00	6	16	80	2	40.0	5.5	S6116.0
8.00	8	20	80	2	40.0	7.4	S6118.0
10.00	10	22	100	2	60.0	9.2	S61110.0
12.00	12	25	100	2	60.0	11.0	S61112.0
14.00	14	32	125	2	85.0	13.0	S61114.0
16.00	16	32	125	2	85.0	15.0	S61116.0
20.00	20	38	125	2	85.0	19.0	S61120.0

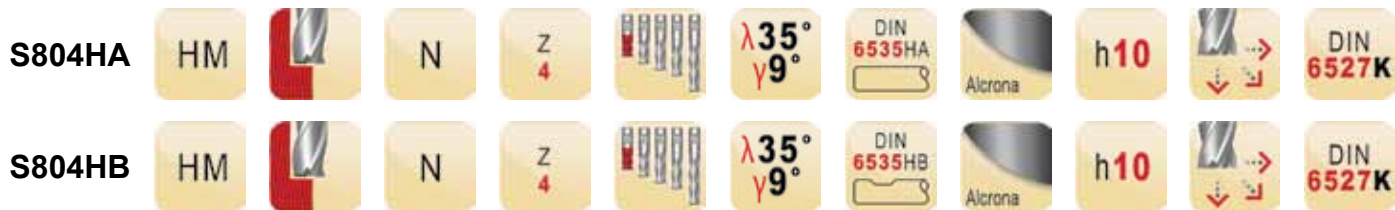

- S804HA** • 立铣刀
• Fresa de Topo
- S804HB** • Fresas de acabado
• End Mill

S804HA; S804HB	▪	1.1	1.2	1.3	1.4	1.5	1.6	2.1	2.2	3.1	3.2	3.3	3.4	6.2	6.3	6.4
	•	2.3	2.4	4.1	4.2	5.1	5.2	6.1	7.1	7.2	7.3	7.4	8.1	8.2		



d_1 Ø mm	d_2 Ø _{h6} mm	l_2 mm	l_1 mm	z	S804HA	S804HB
2.00	6	4	50	4	S804HA2.0	S804HB2.0
3.00	6	5	50	4	S804HA3.0	S804HB3.0
4.00	6	8	54	4	S804HA4.0	S804HB4.0
5.00	6	9	54	4	S804HA5.0	S804HB5.0
6.00	6	10	54	4	S804HA6.0	S804HB6.0
8.00	8	12	58	4	S804HA8.0	S804HB8.0
10.00	10	14	66	4	S804HA10.0	S804HB10.0
12.00	12	16	73	4	S804HA12.0	S804HB12.0
16.00	16	22	82	4	S804HA16.0	S804HB16.0
20.00	20	26	92	4	S804HA20.0	S804HB20.0
25.00	25	32	121	4	S804HA25.0	S804HB25.0

S219



- 立铣刀
- Fresa de Topo
- Fresas de acabado
- End Mill

S219

S219 ■ 1.6 2.3 2.4 4.3 5.3



d_1 Ø mm	d_2 Ø _{h₆} mm	l_2 mm	l_1 mm	z	l_3 mm	d_3 Ø mm	S219
3.00	3	5	60	4	30.0	2.8	S2193.0
4.00	4	8	60	4	32.0	3.7	S2194.0
5.00	5	9	60	4	32.0	4.6	S2195.0
6.00	6	10	75	4	40.0	5.5	S2196.0
8.00	8	12	75	4	40.0	7.4	S2198.0
10.00	10	14	75	4	40.0	9.2	S21910.0
12.00	12	16	100	4	60.0	11.0	S21912.0
14.00	14	22	125	4	85.0	13.0	S21914.0
16.00	16	22	125	4	85.0	15.0	S21916.0
18.00	18	26	125	4	85.0	17.0	S21918.0
20.00	20	26	125	4	85.0	19.0	S21920.0

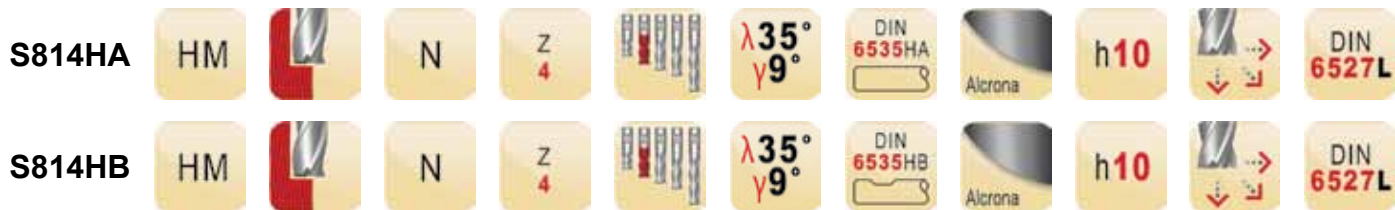

S814HA • 立铣刀
• Fresa de Topo

S814HB • Fresas de acabado
• End Mill

S814HA; S814HB	▪ 1.1	1.2	1.3	1.4	1.5	2.1	3.1	3.2	3.3	3.4	6.2	6.3	6.4	
	• 1.6	2.2	2.3	4.1	4.2	5.1	5.2	6.1	7.1	7.2	7.3	7.4	8.1	8.2



d_1 Ø mm	d_2 Ø _{h6} mm	l_2 mm	l_1 mm	z	S814HA	S814HB
2.00	6	7	57	4	S814HA2.0	S814HB2.0
3.00	6	8	57	4	S814HA3.0	S814HB3.0
4.00	6	11	57	4	S814HA4.0	S814HB4.0
5.00	6	13	57	4	S814HA5.0	S814HB5.0
6.00	6	13	57	4	S814HA6.0	S814HB6.0
8.00	8	19	63	4	S814HA8.0	S814HB8.0
10.00	10	22	72	4	S814HA10.0	S814HB10.0
12.00	12	26	83	4	S814HA12.0	S814HB12.0
16.00	16	32	92	4	S814HA16.0	S814HB16.0
20.00	20	38	104	4	S814HA20.0	S814HB20.0
25.00	25	45	121	4	S814HA25.0	S814HB25.0

S612

HM



N

Z

4



$\lambda 40^\circ$
 $\gamma 10^\circ$

DIN
6535HA



h9



DORMER

S612

- 立铣刀
- Fresa de Topo
- Fresas de acabado
- End Mill

S612 ■ 10.1



S612



1.00 - 12.00

d_1 \varnothing mm	d_2 $\varnothing h_6$ mm	l_2 mm	l_1 mm	z	S612
1.00	3	3	40	4	S6121.0
1.50	3	4.5	40	4	S6121.5
2.00	3	6.5	40	4	S6122.0
2.50	3	6.5	40	4	S6122.5
3.00	3	9	40	4	S6123.0
4.00	4	12	50	4	S6124.0
5.00	5	15	50	4	S6125.0
6.00	6	20	60	4	S6126.0
8.00	8	20	64	4	S6128.0
10.00	10	22	70	4	S61210.0
12.00	12	25	75	4	S61212.0

S216



- 立铣刀
- Fresa de Topo
- Fresas de acabado
- End Mill

S216

S216 ■ 1.6 2.3 2.4 4.3 5.3



d_1 Ø mm	d_2 Ø _{h_s} mm	l_2 mm	l_1 mm	z	S216
2.00	4	6.5	40	4	S2162.0
3.00	3	9	40	4	S2163.0XD3
3.00	6	9	50	4	S2163.0XD6
4.00	4	12	50	4	S2164.0XD4
4.00	6	12	50	4	S2164.0XD6
5.00	5	15	50	4	S2165.0
6.00	6	16	50	4	S2166.0
8.00	8	20	64	4	S2168.0
10.00	10	22	70	4	S21610.0
12.00	12	25	75	4	S21612.0
14.00	14	32	90	4	S21614.0
16.00	16	32	90	4	S21616.0
18.00	18	38	100	4	S21618.0
20.00	20	38	100	4	S21620.0



- S904**
- 立铣刀
 - Fresa de Topo
- S944**
- Fresas de acabado
 - End Mill

S904	▪	1.1	1.2	1.3	1.4	3.1	3.3	4.1	5.1	6.1	6.2	6.3								
	•	1.5	1.6	3.2	3.4	4.2	4.3	5.2	5.3	6.4	7.1	7.2	7.3	8.1	8.2	8.3				
S944	▪	1.1	1.2	1.3	1.4	1.5	3.1	3.2	3.3	3.4	4.1	5.1	6.1	6.2	6.3					
	•	1.6	4.2	4.3	5.2	5.3	6.4	7.1	7.2	7.3	8.1	8.2	8.3							



d ₁ Ø mm	d ₂ Ø _{h₆} mm	l ₂ mm	l ₁ mm	z	S904	S944
2.00	3	6	38	4	S9042.0	S9442.0 ¹⁾
2.50	3	9	38	4	S9042.5	S9442.5 ¹⁾
3.00	3	12	38	4	S9043.0	S9443.0 ¹⁾
4.00	4	14	50	4	S9044.0	S9444.0 ¹⁾
5.00	5	16	50	4	S9045.0	S9445.0 ¹⁾
6.00	6	19	57	4	S9046.0	S9446.0
7.00	8	19	63	4	S9047.0	S9447.0
8.00	8	19	63	4	S9048.0	S9448.0
9.00	10	21	72	4	S9049.0	S9449.0
10.00	10	22	72	4	S90410.0	S94410.0
12.00	12	25	73	4	S90412.0	S94412.0
14.00	14	30	83	4	S90414.0	S94414.0
16.00	16	32	92	4	S90416.0	S94416.0
18.00	18	32	92	4	S90418.0	S94418.0
20.00	20	38	104	4	S90420.0	S94420.0

¹⁾ 圆柱柄 / Haste cilíndrica / Mango cilíndrico / Cylindrical shank



- S717** • 立铣刀
• Fresa de Topo
- S217** • Fresas de acabado
• End Mill

S717	▪	1.1	1.2	1.3	1.4	1.5	2.1	2.2	3.1	3.2	3.3	3.4	4.2	5.2
S217	▪	1.6	2.3	2.4	4.3	5.3								



d_1 Ø mm	d_2 Ø _{h6} mm	l_2 mm	l_1 mm	z	S717	S217
3.00	3	19	60	4	S7173.0	S2173.0XD3
3.00	6	19	75	4		S2173.0XD6
4.00	4	19	60	4	S7174.0	S2174.0XD4
4.00	6	19	75	4		S2174.0XD6
5.00	5	19	60	4	S7175.0	S2175.0
6.00	6	31	75	4	S7176.0	S2176.0
8.00	8	31	75	4	S7178.0	S2178.0
10.00	10	31	75	4	S71710.0	S21710.0
12.00	12	50	100	4	S71712.0	S21712.0
14.00	14	57	125	4	S71714.0	S21714.0
16.00	16	57	125	4	S71716.0	S21716.0
18.00	18	57	125	4	S71718.0	S21718.0
20.00	20	57	125	4	S71720.0	S21720.0



- S718**
- 立铣刀
 - Fresa de Topo
- S218**
- Fresas de acabado
 - End Mill

S718	▪	1.1	1.2	1.3	1.4	1.5	2.1	2.2	3.1	3.2	3.3	3.4	4.2	5.2
S218	▪	1.6	2.3	2.4	4.3	5.3								



d_1 Ø mm	d_2 Ø _{h6} mm	l_2 mm	l_1 mm	z	S718	S218
3.00	3	25	100	4	S7183.0	S2183.0
4.00	4	31	100	4	S7184.0	S2184.0
5.00	5	31	100	4	S7185.0	S2185.0
6.00	6	38	100	4	S7186.0	S2186.0
8.00	8	41	100	4	S7188.0	S2188.0
10.00	10	57	125	4	S71810.0	S21810.0
12.00	12	75	150	4	S71812.0	S21812.0
14.00	14	75	150	4	S71814.0	S21814.0
16.00	16	75	150	4	S71816.0	S21816.0
18.00	18	75	150	4	S71818.0	S21818.0
20.00	20	75	150	4	S71820.0	S21820.0

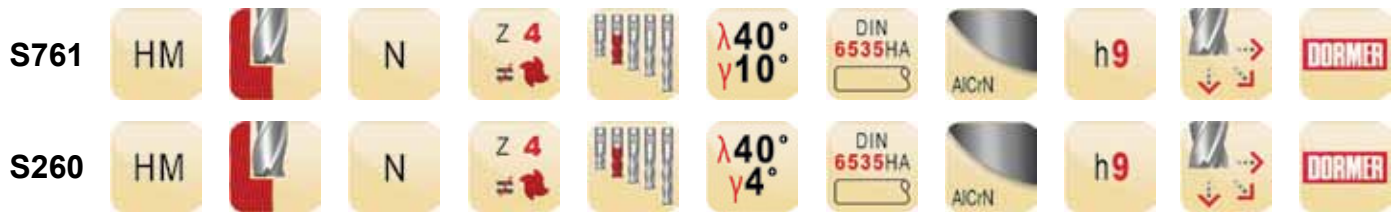

- S761**
- 立铣刀
 - Fresa de Topo
- S260**
- Fresas de acabado
 - End Mill

S761	▪	1.1	1.2	1.3	1.4	1.5	2.1	2.2	3.1	3.2	3.3	3.4	4.2	5.2
S260	▪	1.6	1.7	2.3	2.4	4.3	5.3							



d_1 Ø mm	d_2 Ø _{h6} mm	l_2 mm	l_1 mm	z	S761	S260
3.00	6	9	57	4	S7613.0	S2603.0
4.00	6	12	57	4	S7614.0	S2604.0
5.00	6	13	57	4	S7615.0	S2605.0
6.00	6	13	57	4	S7616.0	S2606.0
8.00	8	20	64	4	S7618.0	S2608.0
10.00	10	22	72	4	S76110.0	S26010.0
12.00	12	26	83	4	S76112.0	S26012.0
14.00	14	32	83	4	S76114.0	S26014.0
16.00	16	32	92	4	S76116.0	S26016.0
18.00	18	38	92	4		S26018.0
20.00	20	38	104	4	S76120.0	S26020.0

S766



S766

- 立铣刀
- Fresa de Topo
- Fresas de acabado
- End Mill

S766 ■ 1.1 1.2 1.3 1.4 1.5 2.1 2.2 3.1 3.2 3.3 3.4 4.2 5.2



d_1 Ø mm	d_2 Ø _{h6} mm	l_2 mm	l_1 mm	z	S766
4.00	6	11	57	4	S7664.0
5.00	6	13	57	4	S7665.0
6.00	6	13	57	4	S7666.0
8.00	8	20	64	4	S7668.0
10.00	10	22	72	4	S76610.0
12.00	12	26	83	4	S76612.0
14.00	14	26	83	4	S76614.0
16.00	16	32	92	4	S76616.0
20.00	20	38	104	4	S76620.0

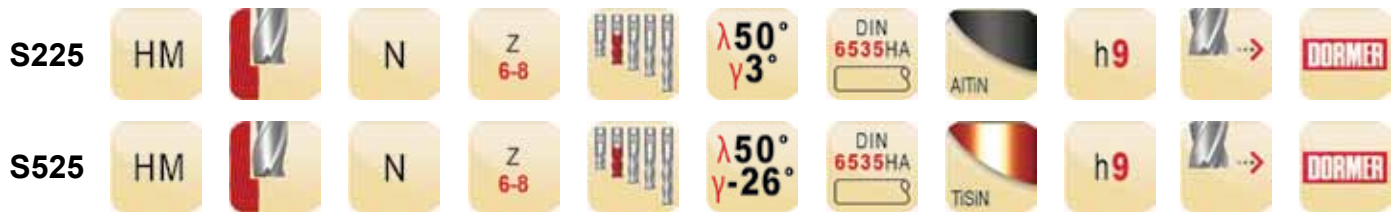

- S225**
- 精切立铣刀
 - Fresa de Topo para Acabamento
- S525**
- Fresa de acabado
 - Finishing End Mill

S225	▪	1.6	2.3	2.4	4.3	5.3
S525	▪	1.7	1.8			



d_1 Ø mm	d_2 Ø _{h6} mm	l_2 mm	l_1 mm	z	l_3 mm	d_3 Ø mm	S225	S525
3.00	6	8	50	6	20.0	2.8	S2253.0	S5253.0
4.00	6	11	50	6	20.0	3.7	S2254.0	S5254.0
6.00	6	15	50	6	20.0	5.5	S2256.0	S5256.0
8.00	8	20	64	6	30.0	7.4	S2258.0	S5258.0
10.00	10	22	70	6	32.0	9.2	S22510.0	S52510.0
12.00	12	25	75	6	37.0	11.0	S22512.0	S52512.0
14.00	14	30	90	6	44.0	13.0	S22514.0	S52514.0
16.00	16	30	90	8	46.0	15.0	S22516.0	S52516.0
18.00	18	35	100	8	53.0	17.0	S22518.0	S52518.0
20.00	20	38	100	8	58.0	19.0	S22520.0	S52520.0

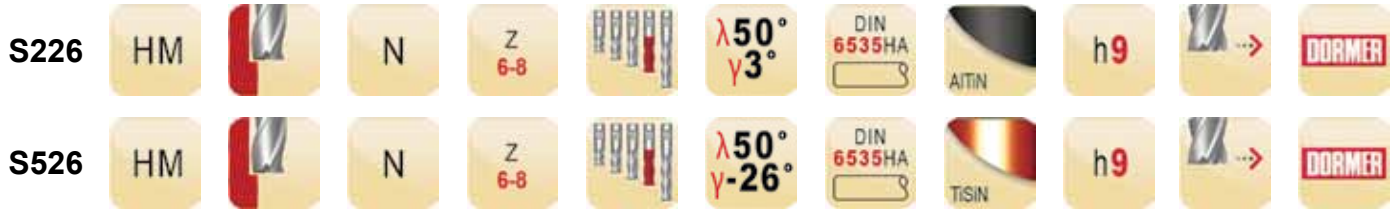

- S226**
- 精切立铣刀
 - Fresa de Topo para Acabamento
- S526**
- Fresa de acabado
 - Finishing End Mill

S226	▪	1.6	2.3	2.4	4.3	5.3
S526	▪	1.7	1.8			



d_1 Ø mm	d_2 Ø _{h6} mm	l_2 mm	l_1 mm	z	l_3 mm	d_3 Ø mm	S226	S526
3.00	6	19	75	6	30.0	2.8	S2263.0	S5263.0
4.00	6	19	75	6	32.0	3.7	S2264.0	S5264.0
6.00	6	31	75	6	40.0	5.5	S2266.0	S5266.0
8.00	8	31	75	6	40.0	7.4	S2268.0	S5268.0
10.00	10	45	100	6	60.0	9.2	S22610.0	S52610.0
12.00	12	50	100	6	60.0	11.0	S22612.0	S52612.0
14.00	14	57	125	6	85.0	13.0	S22614.0	S52614.0
16.00	16	57	125	8	85.0	15.0	S22616.0	S52616.0
18.00	18	57	125	8	85.0	17.0	S22618.0	S52618.0
20.00	20	57	125	8	85.0	19.0	S22620.0	S52620.0

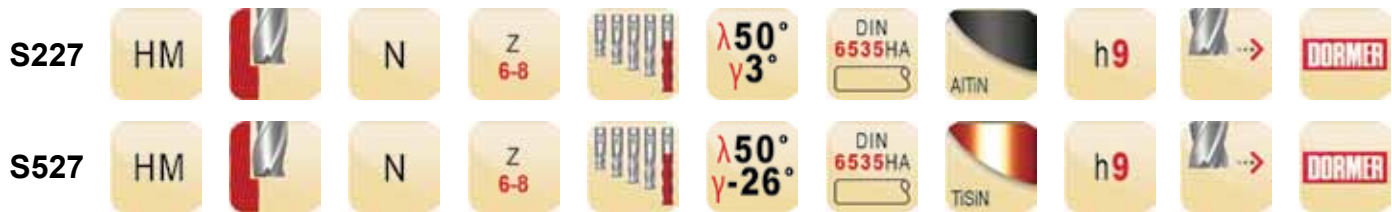

- S227**
- 精切立铣刀
 - Fresa de Topo para Acabamento
- S527**
- Fresa de acabado
 - Finishing End Mill

S227	▪	1.6	2.3	2.4	4.3	5.3
S527	▪	1.7	1.8			



d_1 Ø mm	d_2 Ø h_6 mm	l_2 mm	l_1 mm	z	l_3 mm	d_3 Ø mm	S227	S527
3.00	6	25	100	6	60.0	2.8		S5273.0
4.00	6	31	100	6	60.0	3.7		S5274.0
6.00	6	38	100	6	60.0	5.5	S2276.0	S5276.0
8.00	8	41	100	6	60.0	7.4	S2278.0	S5278.0
10.00	10	57	125	6	85.0	9.2	S22710.0	S52710.0
12.00	12	75	150	6	110.0	11.0	S22712.0	S52712.0
14.00	14	75	150	6	110.0	13.0	S22714.0	S52714.0
16.00	16	75	150	8	110.0	15.0	S22716.0	S52716.0
18.00	18	75	150	8	110.0	17.0	S22718.0	S52718.0
20.00	20	75	150	8	110.0	19.0	S22720.0	S52720.0

S765



- 粗切立铣刀
- Fresa de Topo para Desbaste
- Fresas Gran Desbaste
- Roughing End Mill

S765



d_1 Ø mm	d_2 Ø _{h6} mm	l_2 mm	l_1 mm	z	S765
6.00	6	16	50	4	S7656.0
8.00	8	20	64	4	S7658.0
10.00	10	22	70	4	S76510.0
12.00	12	26	75	4	S76512.0
14.00	14	32	90	4	S76514.0
16.00	16	32	90	4	S76516.0
18.00	18	38	100	4	S76518.0
20.00	20	38	100	4	S76520.0

S264



- 粗切立铣刀
- Fresa de Topo para Desbaste
- Fresas Gran Desbaste
- Roughing End Mill

S264

S264 ■ 1.6 1.7 2.3 2.4 4.3 5.3



d_1 Ø mm	d_2 Ø _{h₉} mm	l_2 mm	l_1 mm	z	S264
6.00	6	13	57	4	S2646.0
8.00	8	20	64	4	S2648.0
10.00	10	22	72	4	S26410.0
12.00	12	26	83	4	S26412.0
14.00	14	26	83	4	S26414.0
16.00	16	32	92	4	S26416.0
18.00	18	32	92	4	S26418.0
20.00	20	38	104	4	S26420.0

S524

HM



N

Z

4



$\lambda 40^\circ$
 $\gamma -6^\circ$

DIN
6535HA



TISIN

h9



DORMER

- 刀尖带圆角的立铣刀
- Fresa de Topo com Raio de Canto
- Fresas con radios en el extremo
- Corner Radius End Mill

S524

S524 ■ 1.7 1.8

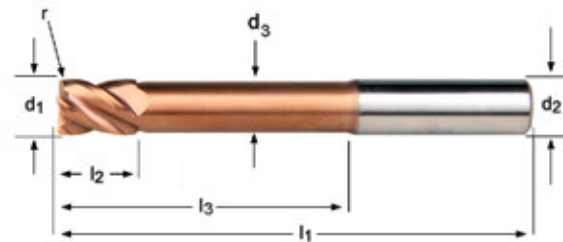

S524



3.00 - 16.00

d_1 Ø mm	r ±0.01 mm	d_2 Ø _{h6} mm	l_2 mm	l_1 mm	z	l_3 mm	d_3 Ø mm	S524
3.00	0.30	6	5	75	4	30.0	2.8	S5243.0XR0.3
4.00	0.30	6	8	75	4	32.0	3.7	S5244.0XR0.3
4.00	0.50	6	8	75	4	32.0	3.7	S5244.0XR0.5
5.00	0.30	6	9	75	4	32.0	4.6	S5245.0XR0.3
5.00	0.50	6	9	75	4	32.0	4.6	S5245.0XR0.5
6.00	0.30	6	10	75	4	40.0	5.5	S5246.0XR0.3
6.00	0.50	6	10	75	4	40.0	5.5	S5246.0XR0.5
6.00	1.00	6	10	75	4	40.0	5.5	S5246.0XR1.0
8.00	0.30	8	12	75	4	40.0	7.4	S5248.0XR0.3
8.00	0.50	8	12	75	4	40.0	7.4	S5248.0XR0.5
8.00	1.00	8	12	75	4	40.0	7.4	S5248.0XR1.0
10.00	0.50	10	14	75	4	40.0	9.2	S52410.0XR0.5
10.00	1.00	10	14	75	4	40.0	9.2	S52410.0XR1.0
10.00	2.00	10	14	75	4	40.0	9.2	S52410.0XR2.0
12.00	0.50	12	16	100	4	60.0	11.0	S52412.0XR0.5
12.00	1.00	12	16	100	4	60.0	11.0	S52412.0XR1.0
12.00	2.00	12	16	100	4	60.0	11.0	S52412.0XR2.0
16.00	0.50	16	22	125	4	85.0	15.0	S52416.0XR0.5
16.00	1.00	16	22	125	4	85.0	15.0	S52416.0XR1.0
16.00	2.00	16	22	125	4	85.0	15.0	S52416.0XR2.0
16.00	3.00	16	22	125	4	85.0	15.0	S52416.0XR3.0

S521



- 刀尖带圆角的立铣刀
- Fresa de Topo com Raio de Canto
- Fresas con radios en el extremo
- Corner Radius End Mill

S521

S521 ■ 1.7 1.8

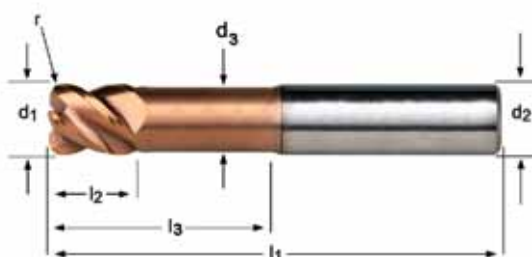

d_1 Ø mm	r ±0.01 mm	d_2 Ø h_6 mm	l_2 mm	l_1 mm	z	l_3 mm	d_3 Ø mm	S521
3.00	0.30	6	4	60	4	14.0	2.8	S5213.0XR0.3
4.00	0.30	6	5	60	4	16.0	3.7	S5214.0XR0.3
4.00	0.50	6	5	60	4	16.0	3.7	S5214.0XR0.5
5.00	0.30	6	6	60	4	18.0	4.6	S5215.0XR0.3
5.00	0.50	6	6	60	4	18.0	4.6	S5215.0XR0.5
6.00	0.50	6	7	60	4	20.0	5.5	S5216.0XR0.5
6.00	1.00	6	7	60	4	20.0	5.5	S5216.0XR1.0
8.00	0.50	8	9	64	4	26.0	7.4	S5218.0XR0.5
8.00	1.00	8	9	64	4	26.0	7.4	S5218.0XR1.0
10.00	1.00	10	11	70	4	31.0	9.2	S52110.0XR1.0
10.00	2.00	10	11	70	4	31.0	9.2	S52110.0XR2.0
12.00	1.00	12	13	75	4	37.0	11.0	S52112.0XR1.0
12.00	2.00	12	13	75	4	37.0	11.0	S52112.0XR2.0
16.00	1.00	16	17	90	4	43.0	15.0	S52116.0XR1.0
16.00	2.00	16	17	90	4	43.0	15.0	S52116.0XR2.0
16.00	3.00	16	17	90	4	43.0	15.0	S52116.0XR3.0

S523

HM



N

Z

4



$\lambda 40^\circ$
 $\gamma -6^\circ$

DIN
6535HA



TiSiN

h9



DORMER

- 刀尖带圆角的立铣刀
- Fresa de Topo com Raio de Canto
- Fresas con radios en el extremo
- Corner Radius End Mill

S523

S523 ■ 1.7 1.8

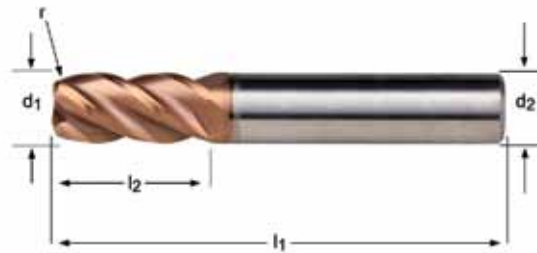

S523



1.50 - 16.00

d_1 \varnothing mm	r ± 0.01 mm	d_2 $\varnothing h_6$ mm	l_2 mm	l_1 mm	z	S523
1.50	0.20	6	4.5	50	4	S5231.5XR0.2
2.00	0.20	6	6.5	50	4	S5232.0XR0.2
3.00	0.20	3	9	40	4	S5233.0XR0.2XD3
3.00	0.30	3	9	40	4	S5233.0XR0.3XD3
3.00	0.20	6	9	50	4	S5233.0XR0.2XD6
3.00	0.30	6	9	50	4	S5233.0XR0.3XD6
3.00	0.50	6	9	50	4	S5233.0XR0.5XD6
4.00	0.30	4	12	50	4	S5234.0XR0.3XD4
4.00	0.50	4	12	50	4	S5234.0XR0.5XD4
4.00	0.30	6	12	50	4	S5234.0XR0.3XD6
4.00	0.50	6	12	50	4	S5234.0XR0.5XD6
5.00	0.30	5	15	50	4	S5235.0XR0.3XD5
5.00	0.50	5	15	50	4	S5235.0XR0.5XD5
5.00	0.30	6	15	50	4	S5235.0XR0.3XD6
5.00	0.50	6	15	50	4	S5235.0XR0.5XD6
6.00	0.30	6	16	50	4	S5236.0XR0.3
6.00	0.50	6	16	50	4	S5236.0XR0.5
6.00	1.00	6	16	50	4	S5236.0XR1.0
8.00	0.30	8	20	64	4	S5238.0XR0.3
8.00	0.50	8	20	64	4	S5238.0XR0.5
8.00	1.00	8	20	64	4	S5238.0XR1.0
8.00	2.00	8	20	64	4	S5238.0XR2.0
10.00	0.50	10	22	70	4	S52310.0XR0.5
10.00	1.00	10	22	70	4	S52310.0XR1.0
10.00	1.50	10	22	70	4	S52310.0XR1.5
10.00	2.00	10	22	70	4	S52310.0XR2.0
12.00	0.50	12	25	75	4	S52312.0XR0.5
12.00	1.00	12	25	75	4	S52312.0XR1.0
12.00	2.00	12	25	75	4	S52312.0XR2.0
12.00	3.00	12	25	75	4	S52312.0XR3.0
16.00	0.50	16	32	90	4	S52316.0XR0.5
16.00	1.00	16	32	90	4	S52316.0XR1.0
16.00	2.00	16	32	90	4	S52316.0XR2.0
16.00	3.00	16	32	90	4	S52316.0XR3.0

S763



- 刀尖带圆角的立铣刀
- Fresa de Topo com Raio de Canto
- Fresas con radios en el extremo
- Corner Radius End Mill

S763

S763 ■ 1.1 1.2 1.3 1.4 1.5 2.1 2.2 3.1 3.2 3.3 3.4 4.2 5.2



S763



3.00 - 20.00

d_1 \varnothing mm	r ± 0.01 mm	d_2 $\varnothing h_6$ mm	l_2 mm	l_1 mm	z	S763
3.00	0.30	3	9	40	4	S7633.0XR0.3
4.00	0.30	4	12	50	4	S7634.0XR0.3
4.00	0.50	4	12	50	4	S7634.0XR0.5
5.00	0.30	5	15	50	4	S7635.0XR0.3
5.00	0.50	5	15	50	4	S7635.0XR0.5
6.00	0.50	6	16	50	4	S7636.0XR0.5
6.00	1.00	6	16	50	4	S7636.0XR1.0
8.00	0.50	8	20	64	4	S7638.0XR0.5
8.00	1.00	8	20	64	4	S7638.0XR1.0
10.00	0.50	10	22	70	4	S76310.0XR0.5
10.00	1.00	10	22	70	4	S76310.0XR1.0
10.00	2.00	10	22	70	4	S76310.0XR2.0
12.00	1.00	12	25	75	4	S76312.0XR1.0
12.00	2.00	12	25	75	4	S76312.0XR2.0
12.00	3.00	12	25	75	4	S76312.0XR3.0
14.00	1.50	14	32	90	4	S76314.0XR1.5
16.00	1.00	16	32	90	4	S76316.0XR1.0
16.00	2.00	16	32	90	4	S76316.0XR2.0
16.00	3.00	16	32	90	4	S76316.0XR3.0
18.00	2.00	18	38	100	4	S76318.0XR2.0
20.00	3.00	20	38	100	4	S76320.0XR3.0

S262

HM



N



- 刀尖帶圓角的立銼刀
- Fresa de Topo com Raio de Canto
- Fresas con radios en el extremo
- Corner Radius End Mill

S262

S262 ■ 1.6 1.7 2.3 2.4 4.3 5.3



d_1 Ø mm	r ±0.01 mm	d_2 Ø _{h6} mm	l_2 mm	l_1 mm	z	S262
3.00	0.30	6	9	50	4	S2623.0XR0.3
3.00	0.50	6	9	50	4	S2623.0XR0.5
4.00	0.30	6	12	57	4	S2624.0XR0.3
4.00	0.50	6	12	57	4	S2624.0XR0.5
4.00	1.00	6	12	57	4	S2624.0XR1.0
5.00	0.30	6	15	57	4	S2625.0XR0.3
5.00	0.50	6	15	57	4	S2625.0XR0.5
6.00	0.30	6	16	57	4	S2626.0XR0.3
6.00	0.50	6	16	57	4	S2626.0XR0.5
6.00	1.00	6	16	57	4	S2626.0XR1.0
8.00	0.30	8	20	64	4	S2628.0XR0.3
8.00	0.50	8	20	64	4	S2628.0XR0.5
8.00	1.00	8	20	64	4	S2628.0XR1.0
8.00	1.50	8	20	64	4	S2628.0XR1.5
8.00	2.00	8	20	64	4	S2628.0XR2.0
10.00	0.30	10	22	72	4	S26210.0XR0.3
10.00	0.50	10	22	72	4	S26210.0XR0.5
10.00	1.00	10	22	72	4	S26210.0XR1.0
10.00	1.50	10	22	72	4	S26210.0XR1.5
10.00	2.00	10	22	72	4	S26210.0XR2.0
12.00	0.30	12	26	83	4	S26212.0XR0.3
12.00	0.50	12	26	83	4	S26212.0XR0.5
12.00	1.00	12	26	83	4	S26212.0XR1.0
12.00	2.00	12	26	83	4	S26212.0XR2.0
12.00	2.50	12	26	83	4	S26212.0XR2.5
12.00	3.00	12	26	83	4	S26212.0XR3.0
14.00	0.30	14	32	83	4	S26214.0XR0.3
14.00	0.50	14	32	83	4	S26214.0XR0.5
14.00	1.00	14	32	83	4	S26214.0XR1.0
14.00	2.00	14	32	83	4	S26214.0XR2.0
14.00	3.00	14	32	83	4	S26214.0XR3.0
16.00	0.30	16	32	92	4	S26216.0XR0.3
16.00	0.50	16	32	92	4	S26216.0XR0.5
16.00	1.00	16	32	92	4	S26216.0XR1.0
16.00	2.00	16	32	92	4	S26216.0XR2.0
16.00	2.50	16	32	92	4	S26216.0XR2.5
16.00	3.00	16	32	92	4	S26216.0XR3.0
16.00	4.00	16	32	92	4	S26216.0XR4.0
18.00	0.30	18	38	92	4	S26218.0XR0.3
18.00	0.50	18	38	92	4	S26218.0XR0.5

d_1 \emptyset mm	r ± 0.01 mm	d_2 $\emptyset h_6$ mm	l_2 mm	l_1 mm	z	S262
18.00	1.00	18	38	92	4	S26218.0XR1.0
18.00	2.00	18	38	92	4	S26218.0XR2.0
18.00	3.00	18	38	92	4	S26218.0XR3.0
20.00	0.30	20	38	104	4	S26220.0XR0.3
20.00	0.50	20	38	104	4	S26220.0XR0.5
20.00	1.00	20	38	104	4	S26220.0XR1.0
20.00	2.00	20	38	104	4	S26220.0XR2.0
20.00	2.50	20	38	104	4	S26220.0XR2.5
20.00	3.00	20	38	104	4	S26220.0XR3.0
20.00	4.00	20	38	104	4	S26220.0XR4.0

S767

HM



N

Z 4



$\lambda \neq$
 $\gamma 10^\circ$

DIN
6535HA



h9



- 刀尖带圆角的立铣刀
- Fresa de Topo com Raio de Canto
- Fresas con radios en el extremo
- Corner Radius End Mill

S767

S767 ■ 1.1 1.2 1.3 1.4 1.5 2.1 2.2 3.1 3.2 3.3 3.4 4.2 5.2



S767



4.00 - 20.00

d_1 Ø mm	r ±0.01 mm	d_2 Øh ₆ mm	l_2 mm	l_1 mm	z	S767
4.00	0.30	6	11	57	4	S7674.0XR0.3
4.00	0.50	6	11	57	4	S7674.0XR0.5
5.00	0.30	6	13	57	4	S7675.0XR0.3
5.00	0.50	6	13	57	4	S7675.0XR0.5
6.00	0.30	6	13	57	4	S7676.0XR0.3
6.00	0.50	6	13	57	4	S7676.0XR0.5
6.00	1.00	6	13	57	4	S7676.0XR1.0
8.00	0.30	8	20	64	4	S7678.0XR0.3
8.00	0.50	8	20	64	4	S7678.0XR0.5
8.00	1.00	8	20	64	4	S7678.0XR1.0
10.00	0.30	10	22	72	4	S76710.0XR0.3
10.00	0.50	10	22	72	4	S76710.0XR0.5
10.00	1.00	10	22	72	4	S76710.0XR1.0
12.00	0.30	12	26	83	4	S76712.0XR0.3
12.00	0.50	12	26	83	4	S76712.0XR0.5
12.00	1.00	12	26	83	4	S76712.0XR1.0
12.00	2.00	12	26	83	4	S76712.0XR2.0
16.00	0.30	16	32	92	4	S76716.0XR0.3
16.00	0.50	16	32	92	4	S76716.0XR0.5
16.00	1.00	16	32	92	4	S76716.0XR1.0
16.00	2.00	16	32	92	4	S76716.0XR2.0
20.00	0.30	20	38	104	4	S76720.0XR0.3
20.00	0.50	20	38	104	4	S76720.0XR0.5
20.00	1.00	20	38	104	4	S76720.0XR1.0
20.00	2.00	20	38	104	4	S76720.0XR2.0

S536



S536

- 高进给立铣刀
- Fresa de Topo de alto avanço
- Fresa de alto avance
- High Feed End Mill

S536 ■ 1.7 1.8

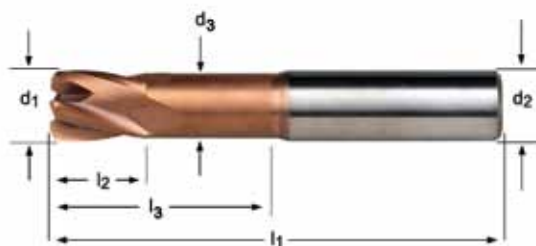

d_1 Ø mm	r ±0.01 mm	d_2 Ø _{h6} mm	l_2 mm	l_1 mm	z	l_3 mm	d_3 Ø mm	S536
6.00	1.00	6	6	60	4	20.0	5.5	S5366.0XR1.0
8.00	2.00	8	8	64	4	24.0	7.4	S5368.0XR2.0
10.00	2.00	10	10	70	4	30.0	9.2	S53610.0XR2.0
12.00	2.00	12	12	75	4	30.0	11.0	S53612.0XR2.0

S229

HM



N

Z
2



$\lambda 30^\circ$
 $\gamma 3^\circ$



h9



- 球头立铣刀
- Fresa de topo esférico
- Fresas con punta esférica
- Ball-Nosed End Mill

S229

S229 ■ 1.6 2.3 2.4 4.3 5.3



S229



1.50 - 16.00

d_1 \varnothing mm	r +0/-0.02 mm	d_2 $\varnothing h_6$ mm	l_2 mm	l_1 mm	z	l_3 mm	d_3 \varnothing mm	S229
1.50	0.75	4	3	40	2	6.0	1.4	S2291.5XD4
2.00	1.00	3	4	40	2	8.0	1.9	S2292.0XD3
2.00	1.00	4	4	40	2	8.0	1.9	S2292.0XD4
3.00	1.50	3	5	40	2	14.0	2.8	S2293.0XD3
3.00	1.50	6	5	50	2	14.0	2.8	S2293.0XD6
4.00	2.00	4	8	50	2	20.0	3.7	S2294.0XD4
4.00	2.00	6	8	50	2	20.0	3.7	S2294.0XD6
5.00	2.50	5	9	50	2	20.0	4.6	S2295.0XD5
5.00	2.50	6	9	50	2	20.0	4.6	S2295.0XD6
6.00	3.00	6	10	50	2	20.0	5.5	S2296.0
8.00	4.00	8	12	64	2	30.0	7.4	S2298.0
10.00	5.00	10	14	70	2	32.0	9.2	S22910.0
12.00	6.00	12	16	75	2	38.0	11.0	S22912.0
14.00	7.00	14	32	90	2	44.0	13.0	S22914.0
16.00	8.00	16	32	90	2	46.0	15.0	S22916.0

S231



- 球头立铣刀
- Fresa de topo esférico
- Fresas con punta esferica
- Ball-Nosed End Mill

S231

S231 ■ 1.6 2.3 2.4 4.3 5.3



S231



1.50 - 16.00

d_1 Ø mm	r +0/-0.02 mm	d_2 Ø _{h6} mm	l_2 mm	l_1 mm	z	l_3 mm	d_3 Ø mm	S231
1.50	0.75	4	3	75	2	10.0	1.4	S2311.5XD4
2.00	1.00	3	4	60	2	14.0	1.9	S2312.0XD3
2.00	1.00	4	4	75	2	14.0	1.9	S2312.0XD4
3.00	1.50	3	5	60	2	21.0	2.8	S2313.0XD3
3.00	1.50	6	5	75	2	21.0	2.8	S2313.0XD6
4.00	2.00	4	8	60	2	28.0	3.7	S2314.0XD4
4.00	2.00	6	8	75	2	28.0	3.7	S2314.0XD6
5.00	2.50	5	9	60	2	32.0	4.6	S2315.0
6.00	3.00	6	10	75	2	40.0	5.5	S2316.0
8.00	4.00	8	12	75	2	40.0	7.4	S2318.0
10.00	5.00	10	14	75	2	40.0	9.2	S23110.0
12.00	6.00	12	16	100	2	60.0	11.0	S23112.0
14.00	7.00	14	32	125	2	80.0	13.0	S23114.0
16.00	8.00	16	32	125	2	80.0	15.0	S23116.0

S233

HM



N

Z
2



$\lambda 30^\circ$
 $\gamma 3^\circ$

DIN
6535HA



h9



- 球头立铣刀
- Fresa de topo esférico
- Fresas con punta esférica
- Ball-Nosed End Mill

S233

S233 ■ 1.6 2.3 2.4 4.3 5.3

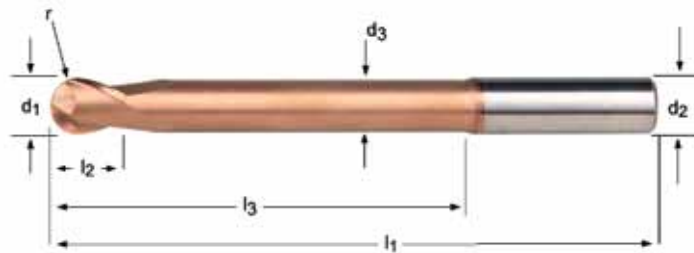

S233



2.00 - 16.00

d_1 \emptyset mm	r +0/-0.02 mm	d_2 $\emptyset h_6$ mm	l_2 mm	l_1 mm	z	l_3 mm	d_3 \emptyset mm	S233
2.00	1.00	3	4	100	2	20.0	1.9	S2332.0XD3
2.00	1.00	4	4	100	2	20.0	1.9	S2332.0XD4
3.00	1.50	3	5	100	2	30.0	2.8	S2333.0XD3
3.00	1.50	6	5	100	2	30.0	2.8	S2333.0XD6
4.00	2.00	4	8	100	2	40.0	3.7	S2334.0XD4
4.00	2.00	6	8	100	2	40.0	3.7	S2334.0XD6
5.00	2.50	5	9	100	2	50.0	4.6	S2335.0
6.00	3.00	6	10	100	2	60.0	5.5	S2336.0
8.00	4.00	8	12	100	2	60.0	7.4	S2338.0
10.00	5.00	10	14	125	2	85.0	9.2	S23310.0
12.00	6.00	12	16	125	2	85.0	11.0	S23312.0
14.00	7.00	14	32	150	2	110.0	13.0	S23314.0
16.00	8.00	16	32	150	2	110.0	15.0	S23316.0

S529



- 球头立铣刀
- Fresa de topo esférico
- Fresas con punta esferica
- Ball-Nosed End Mill

S529

S529 ■ 1.7 1.8

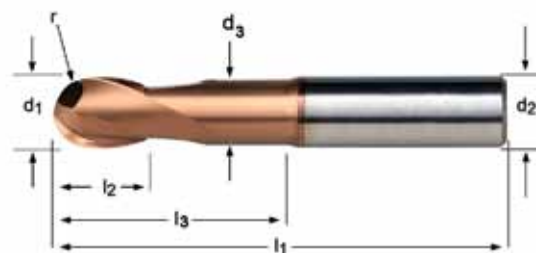

S529



1.50 - 16.00

d_1 Ø mm	r +0/-0.02 mm	d_2 Ø _{h8} mm	l_2 mm	l_1 mm	z	l_3 mm	d_3 Ø mm	S529
1.50	0.75	6	3	50	2	6.0	1.4	S5291.5
2.00	1.00	4	4	40	2	8.0	1.9	S5292.0XD4
2.00	1.00	6	4	50	2	8.0	1.9	S5292.0XD6
3.00	1.50	3	5	40	2	14.0	2.8	S5293.0XD3
3.00	1.50	6	5	50	2	14.0	2.8	S5293.0XD6
4.00	2.00	4	8	50	2	20.0	3.7	S5294.0XD4
4.00	2.00	6	8	50	2	20.0	3.7	S5294.0XD6
5.00	2.50	5	9	50	2	20.0	4.6	S5295.0XD5
5.00	2.50	6	9	50	2	20.0	4.6	S5295.0XD6
6.00	3.00	6	10	50	2	20.0	5.5	S5296.0
8.00	4.00	8	12	64	2	30.0	7.4	S5298.0
10.00	5.00	10	14	70	2	32.0	9.2	S52910.0
12.00	6.00	12	16	75	2	38.0	11.0	S52912.0
14.00	7.00	14	32	90	2	44.0	13.0	S52914.0
16.00	8.00	16	32	90	2	46.0	15.0	S52916.0

S531

HM



N

Z

2



$\lambda 30^\circ$
 $\gamma -10^\circ$

DIN
6535HA



h9



DORMER

- 球头立铣刀
- Fresa de topo esférico
- Fresas con punta esférica
- Ball-Nosed End Mill

S531

S531 ■ 1.7 1.8

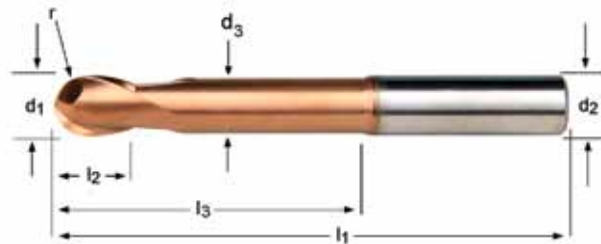

S531



1.50 - 16.00

d_1 Ø mm	r +0/-0.02 mm	d_2 Ø _{h6} mm	l_2 mm	l_1 mm	z	l_3 mm	d_3 Ø mm	S531
1.50	0.75	6	3	75	2	10.0	1.4	S5311.5
2.00	1.00	4	4	75	2	14.0	1.9	S5312.0XD4
2.00	1.00	6	4	75	2	14.0	1.9	S5312.0XD6
3.00	1.50	3	5	60	2	21.0	2.8	S5313.0XD3
3.00	1.50	6	5	75	2	21.0	2.8	S5313.0XD6
4.00	2.00	4	8	60	2	28.0	3.7	S5314.0XD4
4.00	2.00	6	8	75	2	28.0	3.7	S5314.0XD6
5.00	2.50	5	9	60	2	32.0	4.6	S5315.0XD5
5.00	2.50	6	9	75	2	32.0	4.6	S5315.0XD6
6.00	3.00	6	10	75	2	40.0	5.5	S5316.0
8.00	4.00	8	12	75	2	40.0	7.4	S5318.0
10.00	5.00	10	14	75	2	40.0	9.2	S53110.0
12.00	6.00	12	16	100	2	60.0	11.0	S53112.0
14.00	7.00	14	32	125	2	80.0	13.0	S53114.0
16.00	8.00	16	32	125	2	80.0	15.0	S53116.0

S533



- 球头立铣刀
- Fresa de topo esférico
- Fresas con punta esférica
- Ball-Nosed End Mill

S533

S533 ■ 1.7 1.8



d ₁ Ø mm	r +0/-0.02 mm	d ₂ Øh ₆ mm	l ₂ mm	l ₁ mm	z	l ₃ mm	d ₃ Ø mm	S533
2.00	1.00	4	4	100	2	20.0	1.9	S5332.0XD4
2.00	1.00	6	4	100	2	20.0	1.9	S5332.0XD6
3.00	1.50	4	5	100	2	30.0	2.8	S5333.0XD4
3.00	1.50	6	5	100	2	30.0	2.8	S5333.0XD6
4.00	2.00	4	8	100	2	40.0	3.7	S5334.0XD4
4.00	2.00	6	8	100	2	40.0	3.7	S5334.0XD6
5.00	2.50	5	9	100	2	50.0	4.6	S5335.0XD5
5.00	2.50	6	9	100	2	50.0	4.6	S5335.0XD6
6.00	3.00	6	10	100	2	60.0	5.5	S5336.0
8.00	4.00	8	12	100	2	60.0	7.4	S5338.0
10.00	5.00	10	14	125	2	85.0	9.2	S53310.0
12.00	6.00	12	16	125	2	85.0	11.0	S53312.0
14.00	7.00	14	32	150	2	110.0	13.0	S53314.0
16.00	8.00	16	32	150	2	110.0	15.0	S53316.0

S501



- 球头立铣刀
- Fresa de topo esférico
- Fresas con punta esférica
- Ball-Nosed End Mill

S501

S501	▪	1.1	1.2	1.3	1.4	1.5	1.6	2.1	2.2	2.3	3.1	3.2	3.3	3.4	4.1	4.2	4.3	5.1	5.2	5.3	6.1	
		6.2	6.3	6.4	7.1	7.2	7.3	7.4	8.1	8.2	8.3	9.1										
	•	1.7																				



d_1 Ø mm	r ±0.01 mm	d_2 Ø _{h6} mm	l_2 mm	l_1 mm	z	S501
1.00	0.50	3	3	38	2	S5011.0
1.50	0.75	3	3	38	2	S5011.5
2.00	1.00	3	6	38	2	S5012.0
2.50	1.25	3	7	38	2	S5012.5
3.00	1.50	3	7	38	2	S5013.0
4.00	2.00	6	8	57	2	S5014.0
5.00	2.50	6	10	57	2	S5015.0
6.00	3.00	6	10	57	2	S5016.0
7.00	3.50	8	13	63	2	S5017.0
8.00	4.00	8	16	63	2	S5018.0
9.00	4.50	10	16	72	2	S5019.0
10.00	5.00	10	19	72	2	S50110.0
12.00	6.00	12	22	83	2	S50112.0
16.00	8.00	16	26	92	2	S50116.0

S534



- 球头立铣刀
- Fresa de topo esférico
- Fresas con punta esferica
- Ball-Nosed End Mill

S534

S534 ■ 1.7 1.8

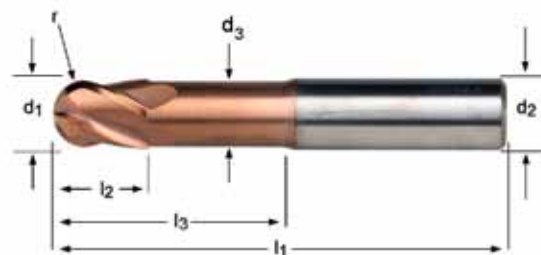

d_1 Ø mm	r +0/-0.02 mm	d_2 Ø _{h8} mm	l_2 mm	l_1 mm	z	l_3 mm	d_3 Ø mm	S534
3.00	1.50	6	5	50	4	14.0	2.8	S5343.0
4.00	2.00	6	8	50	4	20.0	3.7	S5344.0
5.00	2.50	6	9	50	4	20.0	4.6	S5345.0
6.00	3.00	6	10	50	4	20.0	5.5	S5346.0
8.00	4.00	8	12	64	4	30.0	7.4	S5348.0
10.00	5.00	10	14	70	4	32.0	9.2	S53410.0
12.00	6.00	12	16	75	4	38.0	11.0	S53412.0
14.00	7.00	14	32	90	4	44.0	13.0	S53414.0
16.00	8.00	16	32	90	4	46.0	15.0	S53416.0

S535

HM



N

Z

4



$\lambda 30^\circ$
 $\gamma -10^\circ$

DIN
6535HA



h9



DORMER

- 球头立铣刀
- Fresa de topo esférico
- Fresas con punta esférica
- Ball-Nosed End Mill

S535

S535 ■ 1.7 1.8

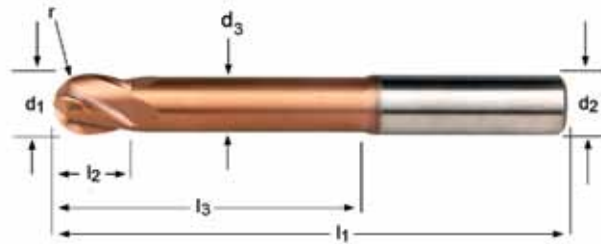

S535



3.00 - 16.00

d_1 Ø mm	r +0/-0.02 mm	d_2 Ø _{h6} mm	l_2 mm	l_1 mm	z	l_3 mm	d_3 Ø mm	S535
3.00	1.50	6	5	75	4	21.0	2.8	S5353.0
4.00	2.00	6	8	75	4	28.0	3.7	S5354.0
5.00	2.50	6	9	75	4	32.0	4.6	S5355.0
6.00	3.00	6	10	75	4	40.0	5.5	S5356.0
8.00	4.00	8	12	75	4	40.0	7.4	S5358.0
10.00	5.00	10	14	75	4	40.0	9.2	S53510.0
12.00	6.00	12	16	100	4	60.0	11.0	S53512.0
14.00	7.00	14	32	125	4	80.0	13.0	S53514.0
16.00	8.00	16	32	125	4	80.0	15.0	S53516.0

S511



- 球头立铣刀
- Fresa de topo esférico
- Fresas con punta esferica
- Ball-Nosed End Mill

S511

S511	1.1	1.2	1.3	1.4	1.5	1.6	2.1	2.2	2.3	3.1	3.2	3.3	3.4	4.1	4.2	4.3	5.1	5.2	5.3	7.3	
	7.4	8.2	8.3	9.1																	
	1.7	6.1	6.2	6.3	6.4	7.1	7.2	8.1													



d_1 Ø mm	r ±0.01 mm	d_2 Ø _{h6} mm	l_2 mm	l_1 mm	z	S511
3.00	1.50	6	8	80	4	S5113.0
4.00	2.00	6	11	80	4	S5114.0
5.00	2.50	6	13	80	4	S5115.0
6.00	3.00	6	13	80	4	S5116.0
7.00	3.50	8	16	100	4	S5117.0
8.00	4.00	8	19	100	4	S5118.0
9.00	4.50	10	19	100	4	S5119.0
10.00	5.00	10	22	100	4	S51110.0
12.00	6.00	12	26	100	4	S51112.0
16.00	8.00	16	32	100	4	S51116.0

S629



- 球头立铣刀
- Fresa de topo esférico
- Fresas con punta esférica
- Ball-Nosed End Mill

S629

S629 ■ 6.1 6.2 6.3 6.4 7.1 7.2 7.3 7.4 8.1 8.2



d_1 Ø mm	r +0/-0.02 mm	d_2 Ø mm	l_2 mm	l_1 mm	z	l_3 mm	d_3 Ø mm	S629
3.00	1.50	6	5	57	2	20.0	2.8	S6293.0
4.00	2.00	6	6	57	2	20.0	3.7	S6294.0
5.00	2.50	6	7	57	2	20.0	4.6	S6295.0
6.00	3.00	6	8	57	2	20.0	5.5	S6296.0
8.00	4.00	8	10	64	2	25.0	7.4	S6298.0
10.00	5.00	10	12	75	2	35.0	9.2	S62910.0
12.00	6.00	12	14	75	2	35.0	11.0	S62912.0
16.00	8.00	16	18	90	2	45.0	15.0	S62916.0
20.00	10.00	20	22	100	2	50.0	19.0	S62920.0



S739

- 倒角立铣刀-60度
- Fresa de chanfro - 60°
- Fresa de chanflán - 60°
- Chamfering End Mill

S740

- 倒角立铣刀-90度
- Fresa de chanfro - 90°
- Fresa de chanflán - 90°
- Chamfering End Mill - 90°

S741

- 倒角立铣刀-120度
- Fresa de chanfro - 120°
- Fresa de chanflán - 120°
- Chamfering End Mill - 120°

S739; S740; S741	1.1	1.2	1.3	1.4	1.5	2.1	2.2	3.1	3.2	3.3	3.4	4.2	5.2	6.1	6.2	6.3	6.4
	7.1	7.2	7.3	7.4													



d_1 Ø mm	d_2 Ø _{h6} mm	l_2 mm	l_1 mm	z	S739	S740	S741
3.00	3	9	40	2	S7393.0	S7403.0	S7413.0
4.00	4	12	50	2	S7394.0	S7404.0	S7414.0
5.00	5	15	50	2	S7395.0	S7405.0	S7415.0
6.00	6	16	50	2	S7396.0	S7406.0	S7416.0
8.00	8	20	64	2	S7398.0	S7408.0	S7418.0
10.00	10	22	70	2	S73910.0	S74010.0	S74110.0
12.00	12	25	75	2	S73912.0	S74012.0	S74112.0
16.00	16	32	90	2	S73916.0	S74016.0	S74116.0
20.00	20	38	100	2	S73920.0	S74020.0	S74120.0

S991

- 套装整体硬质合金铣刀
- Jogo de Fresa de Topo
- Juego de Fresa de Acabamento
- Solid Carbide Cutter Set

A=套件中的型号, B=套件中的数量, C=套件中的直径
 A=Tipos no jogo, B=No. no Jogo, C=Diâmetros no jogo
 A=Tipos en el juego, B=No. en el Juego, C=Diámetros en el Juego
 A=Styles in Set, B=No. in Set, C=Diameters in Set



Nr.	A	B	C	S991
922	S922	6	Ø 3.00 mm, 4.00 mm, 5.00 mm, 6.00 mm, 8.00 mm, 10.00 mm	S991SET922
933	S933	6	Ø 3.00 mm, 4.00 mm, 5.00 mm, 6.00 mm, 8.00 mm, 10.00 mm	S991SET933
944	S944	6	Ø 3.00 mm, 4.00 mm, 5.00 mm, 6.00 mm, 8.00 mm, 10.00 mm	S991SET944



- C110**
- 钻铣刀
 - Fresa de topo para canais
- C126**
- Fresas Frontales
 - Slot Drill

C110	▪	1.1	1.2	4.1	5.1	6.1	6.2	6.3	•	1.3	1.4	2.1	3.1	3.2	3.3	3.4	4.2	5.2	7.1	7.2	7.3	8.1							
C126	▪	1.1	1.2	1.3	1.4	3.1	3.2	3.3	3.4	4.1	4.2	5.1	5.2	6.1	6.2	6.3	•	1.5	1.6	2.1	2.3	4.3	5.3	6.4	7.1	7.2	7.3	7.4	8.1

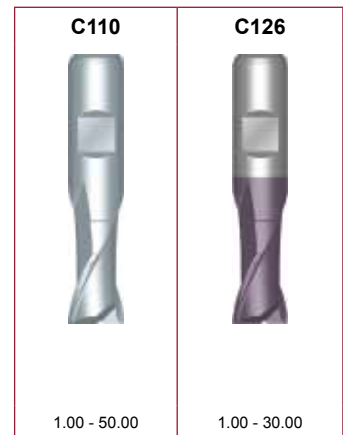
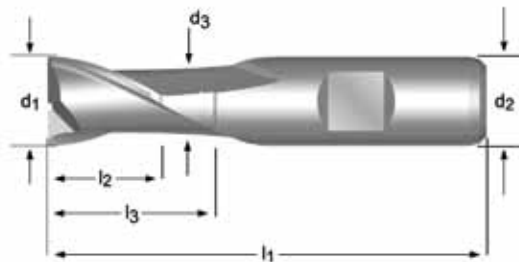

d_1 Ø Inch	d_1 Ø mm	d_2 Ø _{h6} mm	l_2 mm	l_1 mm	z	l_3 mm	d_3 Ø mm	C110	C126
1/16	1.00	6	2.5	47	2	-	-	C1101.0	C1261.0
	1.50	6	3	47	2	-	-	C1101.5	C1261.5
	1.59	6	3	47	2	-	-	C1101/16	
3/32	1.80	6	4	48	2	-	-	C1101.8	
	2.00	6	4	48	2	-	-	C1102.0	C1262.0
	2.38	6	5	49	2	-	-	C1103/32	
1/8	2.50	6	5	49	2	-	-	C1102.5	C1262.5
	2.80	6	5	49	2	-	-	C1102.8	
	3.00	6	5	49	2	-	-	C1103.0	C1263.0
	3.18	6	6	50	2	-	-	C1101/8	
	3.50	6	6	50	2	-	-	C1103.5	C1263.5
3/16	3.80	6	7	51	2	-	-	C1103.8	
	4.00	6	7	51	2	-	-	C1104.0	C1264.0
	4.50	6	7	51	2	-	-	C1104.5	C1264.5
	4.76	6	8	52	2	-	-	C1103/16	
	4.80	6	8	52	2	-	-	C1104.8	²⁾³⁾ C1264.8 ²⁾³⁾
	5.00	6	8	52	2	-	-	C1105.0	C1265.0
	5.50	6	8	52	2	-	-	C1105.5	C1265.5
1/4	5.75	6	8	52	2	-	-	C1105.75	²⁾³⁾ C1265.75 ²⁾³⁾
	6.00	6	8	52	2	-	-	C1106.0	C1266.0
	6.35	10	10	60	2	-	-	C1101/4	
	6.50	10	10	60	2	-	-	C1106.5	C1266.5
	6.75	10	10	60	2	-	-	C1106.75	
	7.00	10	10	60	2	-	-	C1107.0	C1267.0
5/16	7.50	10	10	60	2	-	-	C1107.5	C1267.5
	7.75	10	11	61	2	-	-	C1107.75	²⁾³⁾ C1267.75 ²⁾³⁾
	7.94	10	11	61	2	-	-	C1105/16	
	8.00	10	11	61	2	-	-	C1108.0	C1268.0

²⁾ 直径公差: h10 / Tolerância do Diâmetro h10 / Tolerancia diámetro h10 / diameter tolerance h10

³⁾ 公差P9的二刃立铣刀 / ≠ P9 tolerância / ≠ P9 / slot not in P9 tolerance

d ₁ Ø Inch	d ₁ Ø mm	d ₂ Øh ₆ mm	l ₂ mm	l ₁ mm	z	l ₃ mm	d ₃ Ø mm	C110	C126
	8.50	10	11	61	2	-	-	C1108.5	C1268.5
	9.00	10	11	61	2	-	-	C1109.0	C1269.0
	9.50	10	11	61	2	-	-	C1109.5	C1269.5
3/8	9.52	10	13	63	2	22.5	9.5	C1103/8	
	9.70	10	13	63	2	22.5	9.5	C1109.7 ²⁾³⁾	C1269.7 ²⁾³⁾
	10.00	10	13	63	2	22.5	9.5	C11010.0	C12610.0
13/32	10.32	12	13	70	2	-	-	C11013/32	
	10.50	12	13	70	2	-	-	C11010.5	C12610.5
	11.00	12	13	70	2	-	-	C11011.0	C12611.0
7/16	11.11	12	13	70	2	-	-	C1107/16	
	11.50	12	13	70	2	-	-	C11011.5	C12611.5
	11.70	12	16	73	2	27.5	11.5	C11011.7 ²⁾³⁾	C12611.7 ²⁾³⁾
	12.00	12	16	73	2	27.5	11.5	C11012.0	C12612.0
	12.50	12	16	73	2	27.5	11.5	C11012.5	C12612.5
1/2	12.70	12	16	73	2	27.5	11.5	C1101/2	
	13.00	12	16	73	2	27.5	11.5	C11013.0	C12613.0
17/32	13.49	12	16	73	2	27.5	11.5	C11017/32	
	13.70	12	16	73	2	27.5	11.5	C11013.7 ²⁾³⁾	C12613.7 ²⁾³⁾
	14.00	12	16	73	2	27.5	11.5	C11014.0	C12614.0
9/16	14.29	12	16	73	2	27.5	11.5	C1109/16	
	15.00	12	16	73	2	27.5	11.5	C11015.0	C12615.0
	15.70	16	19	79	2	30.5	15.5	C11015.7 ²⁾³⁾	C12615.7 ²⁾³⁾
5/8	15.88	16	19	79	2	30.5	15.5	C1105/8	
	16.00	16	19	79	2	30.5	15.5	C11016.0	C12616.0
	17.00	16	19	79	2	30.5	15.5	C11017.0	
11/16	17.46	16	19	79	2	30.5	15.5	C11011/16	
	17.70	16	19	79	2	30.5	15.5	C11017.7	
	18.00	16	19	79	2	30.5	15.5	C11018.0	C12618.0
	19.00	16	19	79	2	30.5	15.5	C11019.0	
3/4	19.05	20	22	88	2	37.5	18.5	C1103/4	
	19.70	20	22	88	2	37.5	19.5	C11019.7	
	20.00	20	22	88	2	37.5	19.5	C11020.0	C12620.0
	21.70	20	22	88	2	37.5	19.5	C11021.7	
	22.00	20	22	88	2	37.5	19.5	C11022.0	C12622.0
7/8	22.22	20	22	88	2	37.5	19.5	C1107/8	
	24.00	25	26	102	2	45.5	23.5	C11024.0	C12624.0
	24.70	25	26	102	2	45.5	24.5	C11024.7	
	25.00	25	26	102	2	45.5	24.5	C11025.0	C12625.0
1"	25.40	25	26	102	2	45.5	24.5	C1101	
	26.00	25	26	102	2	45.5	24.5	C11026.0	
	28.00	25	26	102	2	45.5	24.5	C11028.0	
1.1/8	28.58	25	26	102	2	45.5	24.5	C1101.1/8	
	30.00	25	26	102	2	45.5	24.5	C11030.0	C12630.0
1.1/4	31.75	32	32	112	2	51.5	31.5	C1101.1/4	
	32.00	32	32	112	2	51.5	31.5	C11032.0	
	35.00	32	32	112	2	51.5	31.5	C11035.0 ²⁾⁴⁾	
	36.00	32	32	112	2	51.5	31.5	C11036.0 ²⁾⁴⁾	
1.1/2	38.10	40	38	130	2	55.5	37.0	C1101.1/2 ²⁾⁴⁾	
	40.00	40	38	130	2	59.5	39.0	C11040.0 ²⁾⁴⁾	
1.3/4	44.45	40	38	130	2	59.5	38.0	C1101.3/4 ²⁾⁴⁾	
	45.00	40	38	130	2	59.5	38.0	C11045.0 ²⁾⁴⁾	
	50.00	50	45	147	2	66.5	48.0	C11050.0 ²⁾⁴⁾	

²⁾ 直径公差: h10 / Tolerância do Diâmetro h10 / Tolerancia diámetro h10 / diameter tolerance h10

³⁾ 公差P9的二刃立铣刀 / ≠ P9 tolerância / ≠ P9 / slot not in P9 tolerance

⁴⁾ 仅供HSS-E产品 / Disponível apenas em HSS-E / Disponible solo en HSS-E / Available in HSS-E only



- C123**
- 钻铣刀
 - Fresa de topo para canais
- C139**
- Fresas Frontales
 - Slot Drill

C123	▪	1.1	1.2	1.3	1.4	4.1	5.1	6.1	6.2	6.3						
	•	2.1	3.1	3.2	3.3	3.4	4.2	5.2	7.1	7.2	7.3	8.1				
C139	▪	1.1	1.2	1.3	1.4	3.1	3.2	3.3	3.4	4.1	4.2	5.1	5.2	6.1	6.2	6.3
	•	1.5	1.6	2.1	2.3	4.3	5.3	6.4	7.1	7.2	7.3	7.4	8.1			

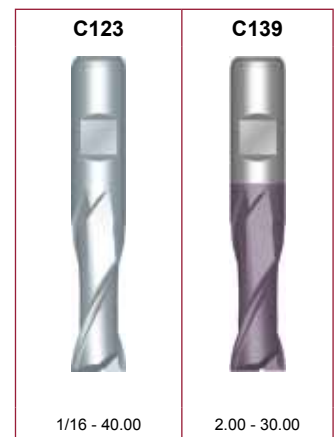
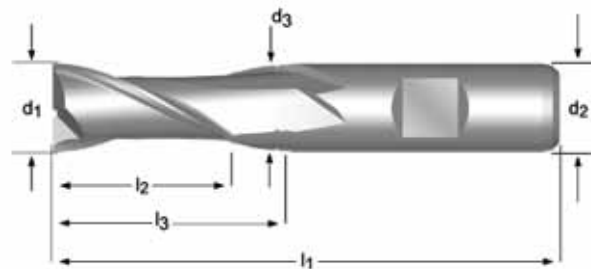

d_1 Ø Inch	d_1 Ø mm	d_2 Ø _{h6} mm	l_2 mm	l_1 mm	z	l_3 mm	d_3 Ø mm	C123	C139
1/16	1.59	6	7	51	2	-	-	C1231/16	4)
	2.00	6	7	51	2	-	-	C1232.0	C1392.0
	2.50	6	8	52	2	-	-	C1232.5	C1392.5
1/8	3.00	6	8	52	2	-	-	C1233.0	C1393.0
	3.18	6	10	54	2	-	-	C1231/8	4)
	3.50	6	10	54	2	-	-	C1233.5	C1393.5
5/32	3.97	6	11	55	2	-	-	C1235/32	4)
	4.00	6	11	55	2	-	-	C1234.0	C1394.0
	4.50	6	11	55	2	-	-	C1234.5	C1394.5
3/16	4.76	6	13	57	2	-	-	C1233/16	4)
	5.00	6	13	57	2	-	-	C1235.0	C1395.0
	5.50	6	13	57	2	-	-	C1235.5	C1395.5
	6.00	6	13	57	2	-	-	C1236.0	C1396.0
1/4	6.35	10	16	66	2	-	-	C1231/4	4)
	6.50	10	16	66	2	-	-	C1236.5	C1396.5
	7.00	10	16	66	2	-	-	C1237.0	C1397.0
	7.50	10	16	66	2	-	-	C1237.5	C1397.5
5/16	7.94	10	19	69	2	-	-	C1235/16	4)
	8.00	10	19	69	2	-	-	C1238.0	C1398.0
	8.50	10	19	69	2	-	-	C1238.5	C1398.5
	9.00	10	19	69	2	-	-	C1239.0	C1399.0
	9.50	10	19	69	2	-	-	C1239.5	C1399.5
3/8	9.52	10	22	72	2	31.5	9.5	C1233/8	4)
	10.00	10	22	72	2	31.5	9.5	C12310.0	C13910.0
	11.00	12	22	79	2	-	-	C12311.0	C13911.0
	12.00	12	26	83	2	37.5	11.5	C12312.0	C13912.0

4) 直径公差: - 0.0005 英寸 / - 0.0013 英寸 / tolerância do diâmetro -0.0005 polegadas / -0.0013 polegadas / Tolerancia diámetro -.0005 pulgadas / -.0013 pulgadas / diameter tolerance -0.0005 inches / -0.0013 inches

d ₁ ∅ Inch	d ₁ ∅ mm	d ₂ ∅ _{h₆} mm	l ₂ mm	l ₁ mm	z	l ₃ mm	d ₃ ∅ mm	C123	C139
1/2	12.70	12	26	83	2	37.5	11.5	C1231/2 ⁴⁾	
	13.00	12	26	83	2	37.5	11.5	C12313.0	C13913.0
	14.00	12	26	83	2	37.5	11.5	C12314.0	C13914.0
9/16	14.29	12	26	83	2	37.5	11.5	C1239/16 ⁴⁾	
	15.00	12	26	83	2	37.5	11.5	C12315.0	C13915.0
5/8	15.88	16	32	92	2	43.5	15.5	C1235/8 ⁴⁾	
	16.00	16	32	92	2	43.5	15.5	C12316.0	C13916.0
	18.00	16	32	92	2	43.5	15.5	C12318.0	C13918.0
3/4	19.05	20	38	104	2	53.5	18.5	C1233/4 ⁵⁾	
	20.00	20	38	104	2	53.5	19.5	C12320.0	C13920.0
	22.00	20	38	104	2	53.5	19.5	C12322.0	C13922.0
	25.00	25	45	121	2	64.5	24.5	C12325.0	C13925.0
1"	25.40	25	45	121	2	64.5	24.5	C1231	
	30.00	25	45	121	2	64.5	24.5	C12330.0	C13930.0
	32.00	32	53	133	2	72.5	31.5	C12332.0	
	36.00	32	53	133	2	72.5	31.5	C12336.0 ⁶⁾	
	1.1/2	38.10	40	63	155	2	84.5	37.0	C1231.1/2 ⁶⁾⁵⁾
40.00		40	63	155	2	84.5	39.0	C12340.0 ⁶⁾	

⁴⁾ 直径公差: - 0.0005 英寸 / - 0.0013 英寸 / tolerância do diâmetro -0.0005 polegadas / -0.0013 polegadas / Tolerancia diámetro -.0005 pulgadas / -.0013 pulgadas / diameter tolerance -0.0005 inches / -0.0013 inches

⁵⁾ 直径公差: - 0.0005 英寸 / - 0.0015 英寸 / tolerância do diâmetro -0.0005 polegadas / -0.0015 polegadas / Tolerancia diámetro -.0005 pulgadas / -.0015 pulgadas / diameter tolerance -0.0005 inches / -0.0015 inches

⁶⁾ 仅供HSS-E产品 / Disponível apenas em HSS-E / Disponible solo en HSS-E / Available in HSS-E only

C135



- 钻铣刀
- Fresa de topo para canais
- Fresas Frontales
- Slot Drill

C135

C135	▪	1.1	1.2	5.1	6.1	6.2	6.3										
	•	1.3	1.4	2.1	3.1	3.2	3.3	3.4	4.1	4.2	5.2	7.1	7.2	7.3	8.1		

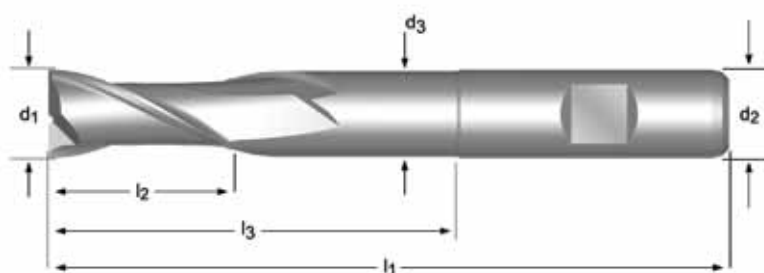

d_1 Ø mm	d_2 Ø _{h6} mm	l_2 mm	l_1 mm	z	l_3 mm	d_3 Ø mm	C135
2.00	6	7	54	2	18.0	1.8	C1352.0
3.00	6	8	56	2	20.0	2.8	C1353.0
4.00	6	11	63	2	27.0	3.7	C1354.0
5.00	6	13	68	2	32.0	4.7	C1355.0
6.00	6	13	68	2	32.0	5.7	C1356.0
7.00	10	16	80	2	40.0	6.5	C1357.0
8.00	10	19	88	2	48.0	7.5	C1358.0
9.00	10	19	88	2	48.0	8.5	C1359.0
10.00	10	22	95	2	54.5	9.5	C13510.0
11.00	12	22	102	2	57.0	10.5	C13511.0
12.00	12	26	110	2	64.5	11.5	C13512.0
13.00	12	26	110	2	64.5	11.5	C13513.0
14.00	12	26	110	2	64.5	11.5	C13514.0
15.00	12	26	110	2	64.5	11.5	C13515.0
16.00	16	32	123	2	74.5	15.5	C13516.0
17.00	16	32	123	2	74.5	15.5	C13517.0
18.00	16	32	123	2	74.5	15.5	C13518.0
19.00	16	32	123	2	74.5	15.5	C13519.0
20.00	20	38	141	2	90.5	19.5	C13520.0
25.00	25	45	166	2	109.5	24.5	C13525.0
30.00	25	45	166	2	109.5	24.5	C13530.0

C306	HSS-E PM		N	Z 3		$\lambda 30^\circ$ $\gamma 12^\circ$	DIN 1835B		e8 h10		DIN 327D
C353	HSS-E PM		N	Z 3		$\lambda 30^\circ$ $\gamma 12^\circ$	DIN 1835B	Alcra	e8 h10		DIN 327D

- C306**
- 钻铣刀
 - Fresa de topo para canais
- C353**
- Fresas Frontales
 - Slot Drill

C306	▪	1.2	1.3	4.1	5.1	6.1	6.2	6.3	•	1.1	1.4	2.1	3.1	3.2	3.3	3.4	4.2	5.2	7.2	7.3	8.1								
C353	▪	1.2	1.3	1.4	1.5	3.1	3.2	3.3	3.4	4.1	4.2	5.1	5.2	6.1	6.2	6.3	•	1.1	1.6	2.1	2.2	2.3	4.3	5.3	6.4	7.2	7.3	7.4	8.1

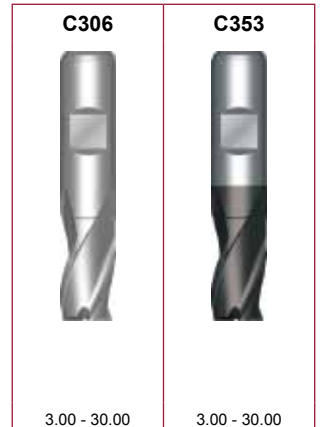
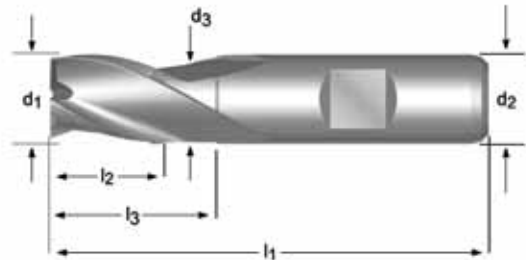

d ₁ Ø mm	d ₂ Øh ₆ mm	l ₂ mm	l ₁ mm	z	l ₃ mm	d ₃ Ø mm	C306	C353
3.00	6	5	49	3	-	-	C3063.0	C3533.0
3.50	6	6	50	3	-	-	C3063.5	C3533.5
4.00	6	7	51	3	-	-	C3064.0	C3534.0
4.50	6	7	51	3	-	-	C3064.5	C3534.5
4.80	6	8	52	3	-	-	C3064.8	C3534.8
5.00	6	8	52	3	-	-	C3065.0	C3535.0
5.50	6	8	52	3	-	-	C3065.5	C3535.5
5.75	6	8	52	3	-	-	C3065.75	C3535.75
6.00	6	8	52	3	-	-	C3066.0	C3536.0
6.50	10	10	60	3	-	-	C3066.5	C3536.5
7.00	10	10	60	3	-	-	C3067.0	C3537.0
7.50	10	10	60	3	-	-	C3067.5	C3537.5
7.75	10	11	61	3	-	-	C3067.75	C3537.75
8.00	10	11	61	3	-	-	C3068.0	C3538.0
8.50	10	11	61	3	-	-	C3068.5	C3538.5
9.00	10	11	61	3	-	-	C3069.0	C3539.0
9.50	10	11	61	3	-	-	C3069.5	C3539.5
9.70	10	13	63	3	22.5	9.5	C3069.7	C3539.7
10.00	10	13	63	3	22.5	9.5	C30610.0	C35310.0
11.00	12	13	70	3	-	-	C30611.0	C35311.0
11.70	12	16	73	3	27.5	11.5	C30611.7	C35311.7
12.00	12	16	73	3	27.5	11.5	C30612.0	C35312.0
13.00	12	16	73	3	27.5	11.5	C30613.0	C35313.0
13.70	12	16	73	3	27.5	11.5	C30613.7	C35313.7
14.00	12	16	73	3	27.5	11.5	C30614.0	C35314.0
15.00	12	16	73	3	27.5	11.5	C30615.0	C35315.0
15.70	16	19	79	3	30.5	15.5	C30615.7	C35315.7
16.00	16	19	79	3	30.5	15.5	C30616.0	C35316.0
18.00	16	19	79	3	30.5	15.5	C30618.0	C35318.0
19.00	16	19	79	3	30.5	15.5	C30619.0	C35319.0
19.70	20	22	88	3	37.5	19.5	C30619.7	C35319.7

d_1 Ø mm	d_2 Ø _{h₅} mm	l_2 mm	l_1 mm	z	l_3 mm	d_3 Ø mm	C306	C353
20.00	20	22	88	3	37.5	19.5	C30620.0	C35320.0
22.00	20	22	88	3	37.5	19.5	C30622.0	C35322.0
25.00	25	26	102	3	45.5	24.5	C30625.0	C35325.0
28.00	25	26	102	3	45.5	24.5	C30628.0	C35328.0
30.00	25	26	102	3	45.5	24.5	C30630.0	C35330.0

C367



- 钻铣刀
- Fresa de topo para canais
- Fresas Frontales
- Slot Drill

C367

C367	▪	1.1	1.2	2.1	2.2	2.3	2.4	6.1	7.1
	•	1.3	1.4	4.1	5.1	6.2	6.3	7.2	7.3

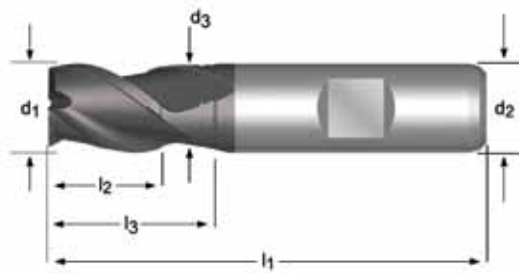

d_1 Ø mm	d_2 Ø _{h6} mm	l_2 mm	l_1 mm	z	l_3 mm	d_3 Ø mm	C367
2.00	6	4	48	3	-	-	C3672.0
3.00	6	5	49	3	-	-	C3673.0
4.00	6	7	51	3	-	-	C3674.0
5.00	6	8	52	3	-	-	C3675.0
6.00	6	8	52	3	-	-	C3676.0
7.00	10	10	60	3	-	-	C3677.0
8.00	10	11	61	3	-	-	C3678.0
9.00	10	11	61	3	-	-	C3679.0
10.00	10	13	63	3	22.5	9.5	C36710.0
11.00	12	13	70	3	-	-	C36711.0
12.00	12	16	73	3	27.5	11.5	C36712.0
13.00	12	16	73	3	27.5	11.5	C36713.0
14.00	12	16	73	3	27.5	11.5	C36714.0
15.00	12	16	73	3	27.5	11.5	C36715.0
16.00	16	19	79	3	30.5	15.5	C36716.0
18.00	16	19	79	3	30.5	15.5	C36718.0
20.00	20	22	88	3	37.5	19.5	C36720.0



- C305**
- 钻铣刀
 - Fresa de topo para canales
- C352**
- Fresas Frontales
 - Slot Drill

C305	▪	1.2	1.3	4.1	5.1	5.2	6.1	6.2	6.3									
	•	1.1	1.4	2.1	3.1	3.2	3.3	3.4	4.2	7.2	7.3	8.1						
C352	▪	1.2	1.3	1.4	1.5	3.1	3.2	3.3	3.4	4.1	4.2	5.1	5.2	6.1	6.2	6.3		
	•	1.1	1.6	2.1	2.2	2.3	4.3	5.3	6.4	7.2	7.3	7.4	8.1					

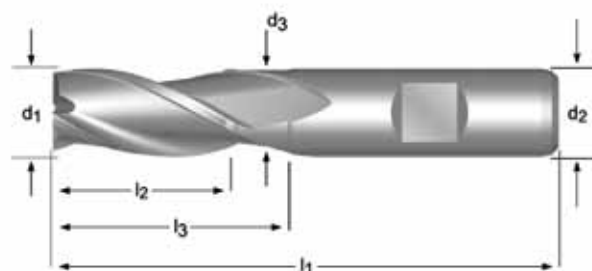

d ₁ Ø mm	d ₂ Øh ₆ mm	l ₂ mm	l ₁ mm	z	l ₃ mm	d ₃ Ø mm	C305	C352
2.00	6	7	51	3	-	-	C3052.0	
2.50	6	8	52	3	-	-	C3052.5	
3.00	6	8	52	3	-	-	C3053.0	C3523.0
3.50	6	10	54	3	-	-	C3053.5	
4.00	6	11	55	3	-	-	C3054.0	C3524.0
4.50	6	11	55	3	-	-	C3054.5	
5.00	6	13	57	3	-	-	C3055.0	C3525.0
5.50	6	13	57	3	-	-	C3055.5	
6.00	6	13	57	3	-	-	C3056.0	C3526.0
6.50	10	16	66	3	-	-	C3056.5	
7.00	10	16	66	3	-	-	C3057.0	
7.50	10	16	66	3	-	-	C3057.5	
8.00	10	19	69	3	-	-	C3058.0	C3528.0
8.50	10	19	69	3	-	-	C3058.5	
9.00	10	19	69	3	-	-	C3059.0	
10.00	10	22	72	3	31.5	9.5	C30510.0	C35210.0
11.00	12	22	79	3	-	-	C30511.0	
12.00	12	26	83	3	37.5	11.5	C30512.0	C35212.0
13.00	12	26	83	3	37.5	11.5	C30513.0	
14.00	12	26	83	3	37.5	11.5	C30514.0	C35214.0
15.00	12	26	83	3	37.5	11.5	C30515.0	
16.00	16	32	92	3	43.5	15.5	C30516.0	C35216.0
17.00	16	32	92	3	43.5	15.5	C30517.0	
18.00	16	32	92	3	43.5	15.5	C30518.0	C35218.0
19.00	16	32	92	3	43.5	15.5	C30519.0	
20.00	20	38	104	3	53.5	19.5	C30520.0	C35220.0
22.00	20	38	104	3	53.5	19.5	C30522.0	
25.00	25	45	121	3	-	-	C30525.0	
28.00	25	45	121	3	-	-	C30528.0	
30.00	25	45	121	3	-	-	C30530.0	
32.00	32	53	133	3	-	-	C30532.0	



- C159**
- 钻铣刀
 - Fresa de topo para canales
- C169**
- Fresas Frontales
 - Slot Drill

C159	▪	1.1	6.1	6.2	6.3	7.1	7.2	7.3	8.1	8.2	
	•	1.2	1.3	2.1	2.2	4.1	5.1				
C169	▪	1.1	1.2	6.1	6.2	6.3	7.1	7.2	7.3	8.1	8.2
	•	1.3	2.1	2.2	2.3	4.1	4.2	5.1	5.2		

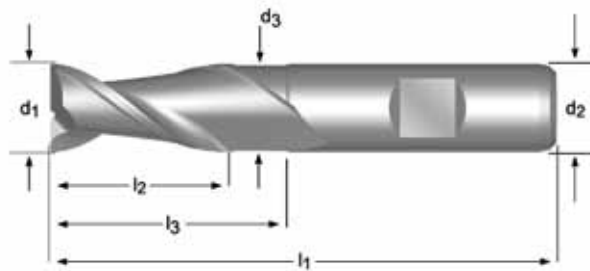

d_1 Ø mm	d_2 Ø _{h6} mm	l_2 mm	l_1 mm	z	l_3 mm	d_3 Ø mm	C159	C169
2.00	6	7	51	2	-	-	C1592.0	C1692.0
3.00	6	8	52	2	-	-	C1593.0	C1693.0
4.00	6	11	55	2	-	-	C1594.0	C1694.0
5.00	6	13	57	2	-	-	C1595.0	C1695.0
6.00	6	13	57	2	-	-	C1596.0	C1696.0
7.00	10	16	66	2	-	-	C1597.0	C1697.0
8.00	10	19	69	2	-	-	C1598.0	C1698.0
10.00	10	22	72	2	-	-	C15910.0	C16910.0
11.00	12	22	79	2	-	-	C15911.0	
12.00	12	26	83	2	-	-	C15912.0	C16912.0
14.00	12	26	83	2	37.5	11.5	C15914.0	C16914.0
16.00	16	32	92	2	43.5	15.5	C15916.0	C16916.0
18.00	16	32	92	2	43.5	15.5	C15918.0	C16918.0
20.00	20	38	104	2	53.5	19.5	C15920.0	C16920.0



- C336**
- 立铣刀
 - Fresa de Topo
- C358**
- Fresas de acabado
 - End Mill

C336	▪	6.1	6.2	6.3	7.1	7.2	7.3	8.1	8.2		
	•	1.1	1.2	1.3	2.1	2.2	4.1	5.1			
C358	▪	1.2	6.1	6.2	6.3	7.1	7.2	7.3	7.4	8.1	8.2
	•	1.1	1.3	2.1	2.2	2.3	4.1	4.2	5.1	5.2	

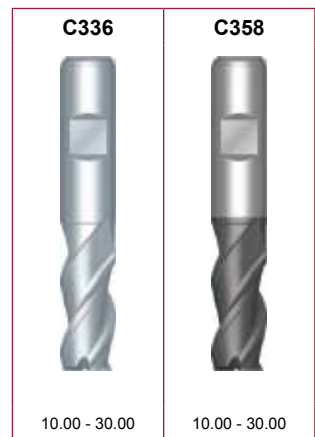
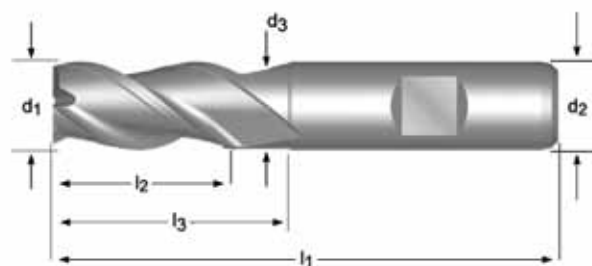

d_1 Ø mm	d_2 Ø _{h6} mm	l_2 mm	l_1 mm	z	l_3 mm	d_3 Ø mm	C336	C358
10.00	10	22	72	3	31.5	9.5	C33610.0	C35810.0
12.00	12	26	83	3	37.5	11.5	C33612.0	C35812.0
14.00	12	26	83	3	37.5	11.5	C33614.0	C35814.0
15.00	12	26	83	3	37.5	11.5	C33615.0	
16.00	16	32	92	3	43.5	15.5	C33616.0	C35816.0
18.00	16	32	92	3	43.5	15.5	C33618.0	C35818.0
20.00	20	38	104	3	53.5	19.5	C33620.0	C35820.0
22.00	20	38	104	3	53.5	19.5	C33622.0	C35822.0
25.00	25	45	121	3	64.5	24.5	C33625.0	C35825.0
30.00	25	45	121	3	64.5	24.5	C33630.0	C35830.0

C167

HSS-E



N

Z
2



λ 30°
 γ 12°

DIN
1835A



js14



- 立铣刀
- Fresa de Topo
- Fresas de acabado
- End Mill

C167

C167	▪	1.1	1.2	5.1	6.1	6.2	6.3								
	•	1.3	1.4	2.1	3.1	3.2	3.3	3.4	4.1	4.2	5.2	7.1	7.2	7.3	8.1

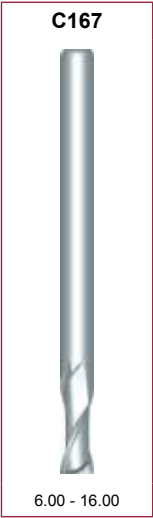
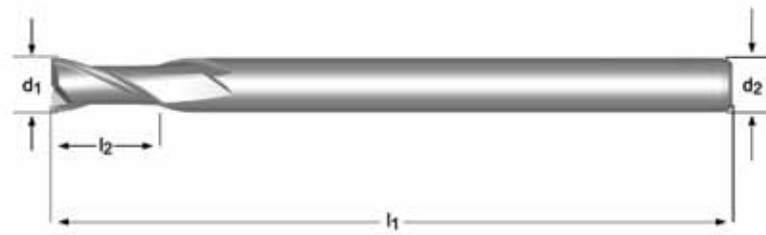

d_1 Ø mm	d_2 Ø _{h6} mm	l_2 mm	l_1 mm	z	C167
6.00	6	13	180	2	C1676.0
8.00	8	19	180	2	C1678.0
10.00	10	22	200	2	C16710.0
12.00	12	26	200	2	C16712.0
16.00	16	32	200	2	C16716.0

C122

HSS-E



N

Z
2



λ 30°
 γ 12°

DIN
1835A



e8



- 立铣刀
- Fresa de Topo
- Fresas de acabado
- End Mill

C122

C122	▪	1.1	1.2	5.1	6.1	6.2	6.3									
	•	1.3	1.4	2.1	3.1	3.2	3.3	3.4	4.1	4.2	5.2	7.1	7.2	7.3	8.1	

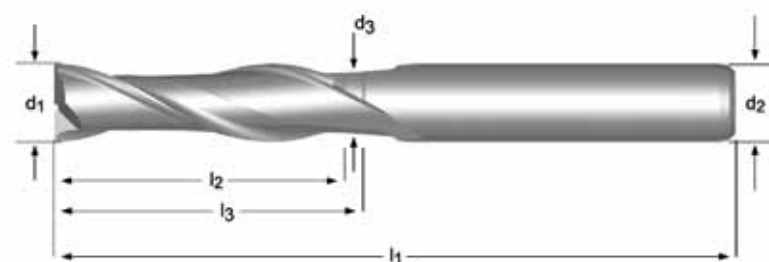

d_1 Ø mm	d_2 Ø _{h6} mm	l_2 mm	l_1 mm	z	l_3 mm	d_3 Ø mm	C122
5.00	5	22	65	2	-	-	C1225.0
6.00	6	27	75	2	-	-	C1226.0
7.00	8	33	85	2	-	-	C1227.0
8.00	8	33	85	2	-	-	C1228.0
10.00	10	40	95	2	-	-	C12210.0
12.00	12	45	110	2	-	-	C12212.0
14.00	12	52	125	2	-	-	C12214.0
16.00	16	58	140	2	69.5	15.5	C12216.0
18.00	16	65	150	2	76.5	15.5	C12218.0
20.00	20	70	160	2	85.5	19.5	C12220.0
22.00	20	75	170	2	90.5	19.5	C12222.0
25.00	25	82	185	2	101.5	24.5	C12225.0
30.00	25	90	205	2	109.5	24.5	C12230.0

C346



- 立铣刀
- Fresa de Topo
- Fresas de acabado
- End Mill

C346

C346	▪	1.2	4.1	5.1	6.1	6.2	6.3							
	•	1.1	1.3	1.4	2.1	3.1	3.2	3.3	3.4	4.2	5.2	7.1	7.2	8.1

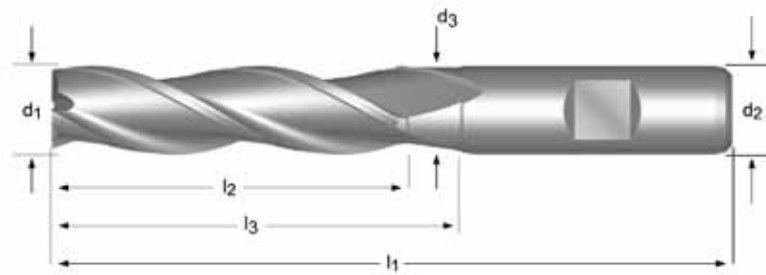

d_1 Ø mm	d_2 Ø _{h8} mm	l_2 mm	l_1 mm	z	l_3 mm	d_3 Ø mm	C346
3.00	6	12	56	3	-	-	C3463.0
4.00	6	19	63	3	-	-	C3464.0
5.00	6	24	68	3	-	-	C3465.0
6.00	6	24	68	3	-	-	C3466.0
7.00	10	30	80	3	-	-	C3467.0
8.00	10	38	88	3	-	-	C3468.0
9.00	10	38	88	3	-	-	C3469.0
10.00	10	45	95	3	-	-	C34610.0
11.00	12	45	102	3	-	-	C34611.0
12.00	12	53	110	3	-	-	C34612.0
13.00	12	53	110	3	64.5	11.5	C34613.0
14.00	12	53	110	3	64.5	11.5	C34614.0
15.00	12	53	110	3	64.5	11.5	C34615.0
16.00	16	63	123	3	74.5	15.5	C34616.0
18.00	16	63	123	3	74.5	15.5	C34618.0
20.00	20	75	141	3	90.5	19.5	C34620.0

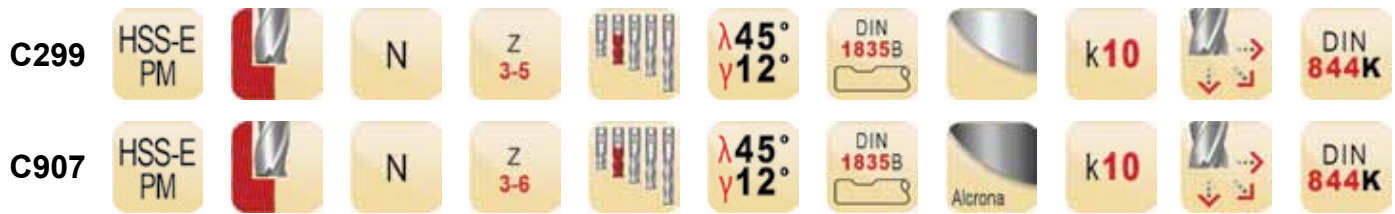

- C299**
- 立铣刀
 - Fresa de Topo
- C907**
- Fresas de acabado
 - End Mill

C299	▪	1.3	1.4	1.5	2.1	2.3	3.1	3.2	3.3	3.4	4.2	4.3	5.1	5.2	5.3	6.2	7.4		
	•	1.6	2.2	4.1															
C907	▪	1.3	1.4	1.5	1.6	2.1	2.2	2.3	3.1	3.2	3.3	3.4	4.2	4.3	5.1	5.2	5.3	6.2	7.4
	•	4.1																	

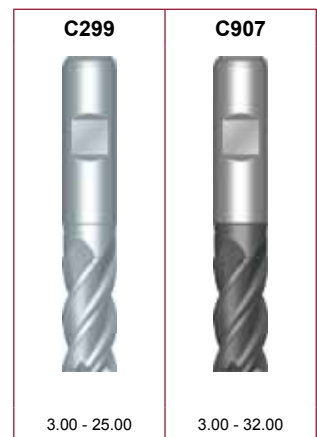
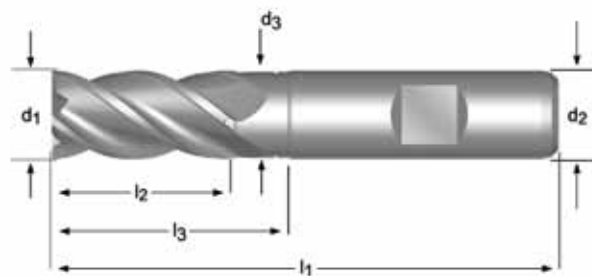

d ₁ Ø mm	d ₂ Øh ₆ mm	l ₂ mm	l ₁ mm	z	l ₃ mm	d ₃ Ø mm	C299	C907
3.00	6	8	52	3	-	-	C2993.0	C9073.0
4.00	6	11	55	3	-	-	C2994.0	C9074.0
5.00	6	13	57	3	-	-	C2995.0	C9075.0
6.00	6	13	57	3	-	-	C2996.0	C9076.0
8.00	10	19	69	4	-	-	C2998.0	C9078.0
10.00	10	22	72	4	31.5	9.5	C29910.0	C90710.0
12.00	12	26	83	4	37.5	11.5	C29912.0	C90712.0
14.00	12	26	83	4	37.5	11.5	C29914.0	C90714.0
16.00	16	32	92	4	43.5	15.5	C29916.0	C90716.0
18.00	16	32	92	4	43.5	15.5	C29918.0	C90718.0
20.00	20	38	104	4	53.5	19.5	C29920.0	C90720.0
22.00	20	38	104	5	53.5	19.5		C90722.0
25.00	25	45	121	5	64.5	24.5	C29925.0	C90725.0
28.00	25	45	121	6	64.5	24.5		C90728.0
30.00	25	45	121	6	64.5	24.5		C90730.0
32.00	32	53	133	6	72.5	31.5		C90732.0

C903	HSS-E PM		N	Z 3-5		$\lambda 45^\circ$ $\gamma 12^\circ$	DIN 1835B		k10		DIN 844L
C920	HSS-E PM		N	Z 3-5		$\lambda 45^\circ$ $\gamma 12^\circ$	DIN 1835B	Alcrona	k10		DIN 844L

- C903**
- 立铣刀
 - Fresa de Topo
- C920**
- Fresas de acabado
 - End Mill

C903	▪	1.3	1.4	1.5	2.1	2.3	3.1	3.2	3.3	3.4	4.2	4.3	5.1	5.2	5.3	6.2	7.4		
	•	1.6	2.2	4.1															
C920	▪	1.3	1.4	1.5	1.6	2.1	2.2	2.3	3.1	3.2	3.3	3.4	4.2	4.3	5.1	5.2	5.3	6.2	7.4
	•	4.1																	

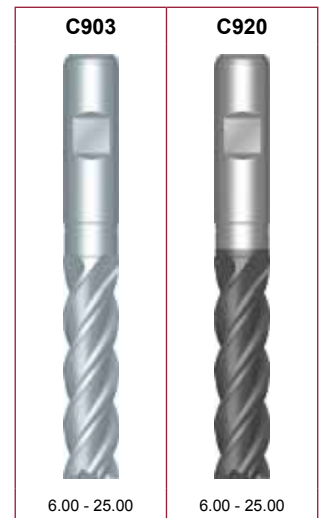
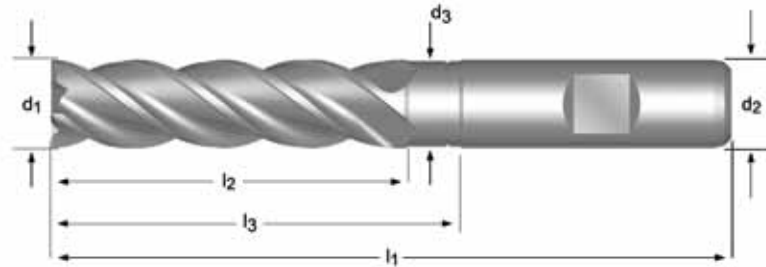

d_1 Ø mm	d_2 Ø _{h6} mm	l_2 mm	l_1 mm	z	l_3 mm	d_3 Ø mm	C903	C920
6.00	6	24	68	3	-	-	C9036.0	C9206.0
8.00	10	38	88	4	-	-	C9038.0	C9208.0
10.00	10	45	95	4	54.5	9.5	C90310.0	C92010.0
12.00	12	53	110	4	64.5	11.5	C90312.0	C92012.0
14.00	12	53	110	4	64.5	11.5	C90314.0	C92014.0
16.00	16	63	123	4	74.5	15.5	C90316.0	C92016.0
18.00	16	63	123	4	74.5	15.5	C90318.0	C92018.0
20.00	20	75	141	4	90.5	19.5	C90320.0	C92020.0
22.00	22	75	141	5	90.5	19.5	C90322.0	C92022.0
25.00	25	90	166	5	109.5	24.5	C90325.0	C92025.0



- C247** • 立铣刀
• Fresa de Topo
- C246** • Fresas de acabado
• End Mill

C247	▪	1.1	1.2	1.3	4.1	5.1	6.1	6.2	6.3												
	•	1.4	2.1	3.1	3.2	3.3	3.4	4.2	5.2	7.1	7.2	7.3	8.1								
C246	▪	1.1	1.2	1.3	1.4	3.1	3.2	3.3	3.4	4.1	4.2	5.1	5.2	6.1	6.2	6.3					
	•	1.5	1.6	2.1	2.3	4.3	5.3	6.4	7.1	7.2	7.3	7.4	8.1								

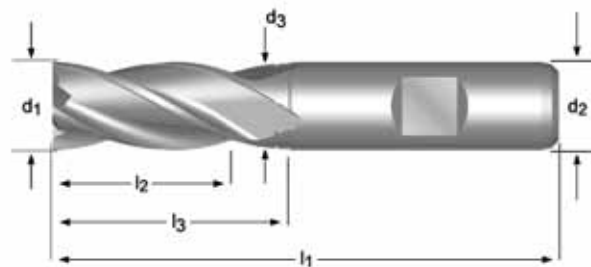

d ₁ Ø Inch	d ₁ Ø mm	d ₂ Øh ₆ mm	l ₂ mm	l ₁ mm	z	l ₃ mm	d ₃ Ø mm	C247	C246
	2.00	6	7	51	4	-	-	C2472.0	C2462.0
	2.50	6	8	52	4	-	-	C2472.5	
	3.00	6	8	52	4	-	-	C2473.0	C2463.0
1/8	3.18	6	10	54	4	-	-	C2471/8	¹⁾
	3.50	6	10	54	4	-	-	C2473.5	
	4.00	6	11	55	4	-	-	C2474.0	C2464.0
	4.50	6	11	55	4	-	-	C2474.5	
3/16	4.76	6	13	57	4	-	-	C2473/16	¹⁾
	5.00	6	13	57	4	-	-	C2475.0	C2465.0
	5.50	6	13	57	4	-	-	C2475.5	
	6.00	6	13	57	4	-	-	C2476.0	C2466.0
1/4	6.35	10	16	66	4	-	-	C2471/4	¹⁾
	6.50	10	16	66	4	-	-	C2476.5	
	7.00	10	16	66	4	-	-	C2477.0	C2467.0
	7.50	10	16	66	4	-	-	C2477.5	
5/16	7.94	10	19	69	4	-	-	C2475/16	¹⁾
	8.00	10	19	69	4	-	-	C2478.0	C2468.0
	8.50	10	19	69	4	-	-	C2478.5	
	9.00	10	19	69	4	-	-	C2479.0	C2469.0
	9.50	10	19	69	4	-	-	C2479.5	
3/8	9.52	10	22	72	4	31.5	9.5	C2473/8	¹⁾
	10.00	10	22	72	4	31.5	9.5	C24710.0	C24610.0
	11.00	12	22	79	4	-	-	C24711.0	C24611.0
	12.00	12	26	83	4	37.5	11.5	C24712.0	C24612.0
1/2	12.70	12	26	83	4	37.5	11.5	C2471/2	¹⁾
	13.00	12	26	83	4	37.5	11.5	C24713.0	C24613.0

¹⁾ 直径公差: + 0.0025 英寸 / - 0.0005 英寸 / tolerância do diâmetro +0.0025 polegadas / -0.0005 polegadas / Tolerancia diâmetro +.0025 pulgadas / -.0005 pulgadas / diameter tolerance +0.025 inches / -0.0005 inches

d ₁ Ø Inch	d ₁ Ø mm	d ₂ Øh ₆ mm	l ₂ mm	l ₁ mm	z	l ₃ mm	d ₃ Ø mm	C247	C246
9/16	14.00	12	26	83	4	37.5	11.5	C24714.0	C24614.0
	14.29	12	26	83	4	37.5	11.5	C2479/16 ¹⁾	
	15.00	12	26	83	4	37.5	11.5	C24715.0	C24615.0
5/8	15.88	16	32	92	4	43.5	15.5	C2475/8 ¹⁾	
	16.00	16	32	92	4	43.5	15.5	C24716.0	C24616.0
	17.00	16	32	92	4	43.5	15.5	C24717.0	
	18.00	16	32	92	4	43.5	15.5	C24718.0	C24618.0
	19.00	16	32	92	4	43.5	15.5	C24719.0	
3/4	19.05	20	38	104	4	53.5	18.5	C2473/4 ¹⁾	
	20.00	20	38	104	4	53.5	19.5	C24720.0	C24620.0
	21.00	20	38	104	4	53.5	19.5	C24721.0	
	22.00	20	38	104	5	53.5	19.5	C24722.0	C24622.0
7/8	22.22	20	38	104	5	53.5	19.5	C2477/8 ¹⁾	
	23.00	20	38	104	5	53.5	19.5	C24723.0	
	24.00	25	45	121	5	64.5	23.5	C24724.0	
	25.00	25	45	121	5	64.5	24.5	C24725.0	C24625.0
	25.40	25	45	121	5	64.5	24.5	C2471 ¹⁾	
1"	26.00	25	45	121	6	64.5	24.5	C24726.0	
	28.00	25	45	121	6	64.5	24.5	C24728.0	C24628.0
	30.00	25	45	121	6	64.5	24.5	C24730.0	C24630.0
	32.00	32	53	133	6	72.5	31.5	C24732.0	C24632.0
	36.00	32	53	133	6	72.5	31.5	C24736.0 ²⁾³⁾	
	40.00	40	63	155	6	84.5	39.0	C24740.0 ²⁾³⁾	
	50.00	50	75	177	8	96.5	48.0	C24750.0 ²⁾³⁾	

¹⁾ 直径公差: + 0.0025 英寸 / - 0.0005 英寸 / tolerância do diâmetro +0.0025 polegadas / -0.0005 polegadas / Tolerancia diámetro +.0025 pulgadas / -.0005 pulgadas / diameter tolerance +0.025 inches / -0.0005 inches

²⁾ 无中心切削 / Sem corte no centro / Sin corte al centro / No centre Cutting

³⁾ 仅供HSS-E产品 / Disponível apenas em HSS-E / Disponible solo en HSS-E / Available in HSS-E only



- C273**
- 立铣刀
 - Fresa de Topo para Acabamento
- C295**
- Fresas de acabado
 - End Mill

C273	▪	1.1	1.2	1.3	4.1	5.1	6.1	6.2	6.3												
	•	1.4	2.1	3.1	3.2	3.3	3.4	4.2	5.2	7.1	7.2	7.3	8.1								
C295	▪	1.1	1.2	1.3	1.4	3.1	3.2	3.3	3.4	4.1	4.2	5.1	5.2	6.1	6.2	6.3					
	•	1.5	1.6	2.1	2.3	4.3	5.3	6.4	7.1	7.2	7.3	7.4	8.1								

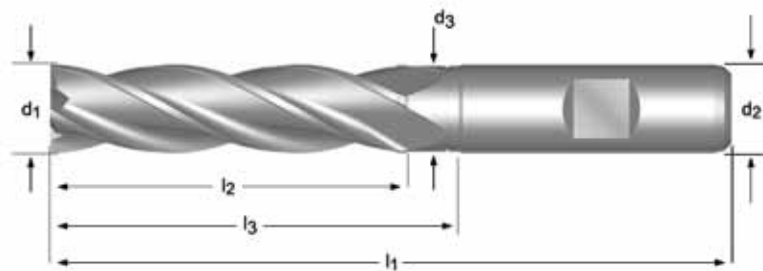

d_1 Ø Inch	d_1 Ø mm	d_2 Ø _{h6} mm	l_2 mm	l_1 mm	z	l_3 mm	d_3 Ø mm	C273	C295
	2.00	6	10	54	4	-	-	C2732.0	C2952.0
	2.50	6	12	56	4	-	-	C2732.5	
	3.00	6	12	56	4	-	-	C2733.0	C2953.0
1/8	3.18	6	15	59	4	-	-	C2731/8	¹⁾
	3.50	6	15	59	4	-	-	C2733.5	
	4.00	6	19	63	4	-	-	C2734.0	C2954.0
	4.50	6	19	63	4	-	-	C2734.5	
3/16	4.76	6	24	68	4	-	-	C2733/16	¹⁾
	5.00	6	24	68	4	-	-	C2735.0	C2955.0
	5.50	6	24	68	4	-	-	C2735.5	
	6.00	6	24	68	4	-	-	C2736.0	C2956.0
1/4	6.35	10	30	80	4	-	-	C2731/4	¹⁾
	7.00	10	30	80	4	-	-	C2737.0	C2957.0
	8.00	10	38	88	4	-	-	C2738.0	C2958.0
	9.00	10	38	88	4	-	-	C2739.0	C2959.0
3/8	9.52	10	45	95	4	54.5	9.5	C2733/8	¹⁾
	10.00	10	45	95	4	54.5	9.5	C27310.0	C29510.0
	11.00	12	45	102	4	-	-	C27311.0	C29511.0
	12.00	12	53	110	4	64.5	11.5	C27312.0	C29512.0
1/2	12.70	12	53	110	4	64.5	11.5	C2731/2	¹⁾
	13.00	12	53	110	4	64.5	11.5	C27313.0	C29513.0
	14.00	12	53	110	4	64.5	11.5	C27314.0	C29514.0
	15.00	12	53	110	4	64.5	11.5	C27315.0	C29515.0
5/8	15.88	16	63	123	4	74.5	15.5	C2735/8	¹⁾

¹⁾ 直径公差: + 0.0025 英寸 / - 0.0005 英寸 / tolerância do diâmetro +0.0025 polegadas / -0.0005 polegadas / Tolerancia diámetro +.0025 pulgadas / -.0005 pulgadas / diameter tolerance +0.025 inches / -0.0005 inches

d ₁ ∅ Inch	d ₁ ∅ mm	d ₂ ∅h ₆ mm	l ₂ mm	l ₁ mm	z	l ₃ mm	d ₃ ∅ mm	C273	C295
	16.00	16	63	123	4	74.5	15.5	C27316.0	C29516.0
	18.00	16	63	123	4	74.5	15.5	C27318.0	C29518.0
3/4	19.05	20	75	141	4	90.5	18.5	C2733/4 ¹⁾	
	20.00	20	75	141	4	90.5	19.5	C27320.0	C29520.0
	22.00	20	75	141	5	90.5	19.5	C27322.0	C29522.0
7/8	22.22	20	75	141	5	90.5	19.5	C2737/8 ¹⁾	
	25.00	25	90	166	5	109.5	24.5	C27325.0	C29525.0
1"	25.40	25	90	166	5	109.5	24.5	C2731 ¹⁾	
	28.00	25	90	166	6	109.5	24.5	C27328.0	C29528.0
	30.00	25	90	166	6	109.5	24.5	C27330.0	C29530.0
	32.00	32	106	186	6	125.5	31.5	C27332.0	C29532.0
	36.00	32	106	186	6	125.5	31.5	C27336.0 ²⁾³⁾	
1.1/2	38.10	40	125	217	6	146.5	37.0	C2731.1/2 ¹⁾²⁾³⁾	
	40.00	40	125	217	6	146.5	39.0	C27340.0 ²⁾³⁾	C29540.0 ²⁾³⁾

¹⁾ 直径公差: + 0.0025 英寸 / - 0.0005 英寸 / tolerância do diâmetro +0.0025 polegadas / -0.0005 polegadas / Tolerancia diámetro +.0025 pulgadas / -.0005 pulgadas / diameter tolerance +0.025 inches / -0.0005 inches

²⁾ 无中心切削 / Sem corte no centro / Sin corte al centro / No centre Cutting

³⁾ 仅供HSS-E产品 / Disponível apenas em HSS-E / Disponible solo en HSS-E / Available in HSS-E only

C166

HSS-E



W

Z
2



λ 40°
 γ 20°

DIN
1835B



e8



DIN
844L

- 立铣刀
- Fresa de Topo
- Fresas de acabado
- End Mill

C166

C166	▪	1.1	6.1	6.2	6.3	7.1	7.2	7.3	8.1	8.2
	•	1.2	1.3	2.1	2.2	4.1	5.1			

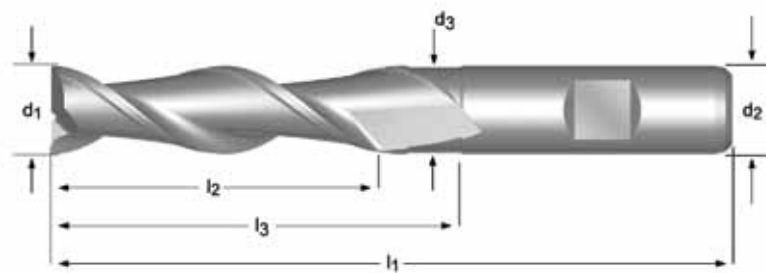

d_1 Ø mm	d_2 Ø _{h6} mm	l_2 mm	l_1 mm	z	l_3 mm	d_3 Ø mm	C166
6.00	6	24	68	2	-	-	C1666.0
7.00	10	30	80	2	-	-	C1667.0
8.00	10	38	88	2	-	-	C1668.0
9.00	10	38	88	2	-	-	C1669.0
10.00	10	45	95	2	-	-	C16610.0
12.00	12	53	110	2	-	-	C16612.0
14.00	12	53	110	2	64.5	11.5	C16614.0
16.00	16	63	123	2	74.5	15.5	C16616.0

C333	HSS-E PM		W	Z 3		$\lambda 40^\circ$ $\gamma 25^\circ$	DIN 1835B		k10		DIN 844L
C359	HSS-E PM		W	Z 3		$\lambda 40^\circ$ $\gamma 25^\circ$	DIN 1835B	Alcrona	k10		DIN 844L

- C333**
- 立铣刀
 - Fresa de Topo
- C359**
- Fresas de acabado
 - End Mill

C333	▪	6.1	7.2									
	•	1.1	1.2	1.3	2.1	2.2	4.1	5.1	7.1	7.3		
C359	▪	1.2	6.1	7.2	7.3	7.4						
	•	1.1	1.3	2.1	2.2	2.3	4.1	4.2	5.1	5.2	6.2	7.1

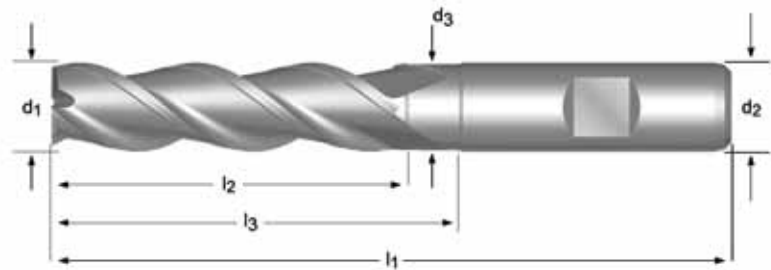

d_1 Ø mm	d_2 Ø _{h6} mm	l_2 mm	l_1 mm	z	l_3 mm	d_3 Ø mm	C333	C359
10.00	10	45	95	3	54.5	9.5	C33310.0	C35910.0
12.00	12	53	110	3	64.5	11.5	C33312.0	C35912.0
14.00	12	53	110	3	64.5	11.5	C33314.0	C35914.0
16.00	16	63	123	3	74.5	15.5	C33316.0	C35916.0
18.00	16	63	123	3	74.5	15.5	C33318.0	C35918.0
20.00	20	75	141	3	90.5	19.5	C33320.0	C35920.0
25.00	25	90	166	3	109.5	24.5	C33325.0	C35925.0
30.00	25	90	166	3	109.5	24.5	C33330.0	C35930.0

C365

HSS-E
PM



FS

Z
3-4



λ 40°
 γ 25°

DIN
1835B



k10



DIN
844K

- 粗切立铣刀
- Fresa de Topo para Desbaste
- Fresas Gran Desbaste
- Roughing End Mill

C365

C365	▪	6.1	6.2	6.3	7.1	7.2	7.3	8.1	8.2
	•	1.1	1.2	1.3	2.1	4.1	5.1		

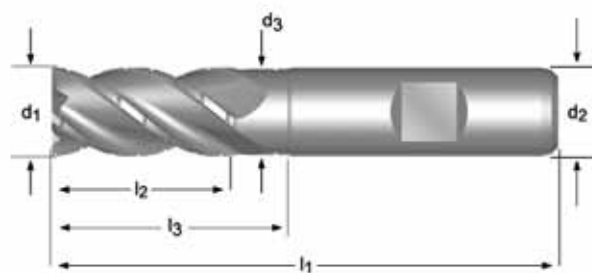

d_1 Ø mm	d_2 Ø _{h6} mm	l_2 mm	l_1 mm	z	l_3 mm	d_3 Ø mm	C365
10.00	10	22	72	3	31.5	9.5	C36510.0
12.00	12	26	83	3	37.5	11.5	C36512.0
14.00	12	26	83	3	37.5	11.5	C36514.0
16.00	16	32	92	3	43.5	15.5	C36516.0
18.00	16	32	92	4	43.5	15.5	C36518.0
20.00	20	38	104	4	53.5	19.5	C36520.0
25.00	25	45	121	4	64.5	24.5	C36525.0
30.00	25	45	121	4	64.5	24.5	C36530.0

C324



- 粗切立铣刀
- Fresa de Topo para Desbaste
- Fresas Gran Desbaste
- Roughing End Mill

C324

C324	▪	1.4	1.5	1.6	2.1	2.2	2.3	3.1	3.2	3.3	3.4	4.2	4.3	5.2	5.3	6.2	7.4
	•	1.3	4.1	5.1	6.4												

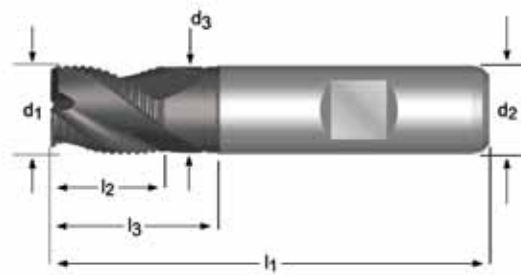

d_1 Ø mm	d_2 Ø _{h6} mm	l_2 mm	l_1 mm	z	l_3 mm	d_3 Ø mm	C324
8.00	10	11	61	3	-	-	C3248.0
10.00	10	13	63	3	22.5	9.5	C32410.0
12.00	12	16	73	3	27.5	11.5	C32412.0
14.00	12	16	73	3	27.5	11.5	C32414.0
16.00	16	19	79	3	30.5	15.5	C32416.0
18.00	16	19	79	3	30.5	15.5	C32418.0
20.00	20	22	88	3	37.5	19.5	C32420.0
22.00	20	22	88	3	37.5	19.5	C32422.0
25.00	25	26	102	3	45.5	24.5	C32425.0
28.00	25	26	102	3	45.5	24.5	C32428.0
30.00	25	26	102	3	45.5	24.5	C32430.0

C922



- 粗切立铣刀
- Fresa de Topo para Desbaste
- Fresas Gran Desbaste
- Roughing End Mill

C922

C922	▪	1.4	1.5	1.6	2.1	2.2	2.3	3.1	3.2	3.3	3.4	4.2	4.3	5.2	5.3	6.2	7.4
	•	1.3	4.1	5.1	6.4												

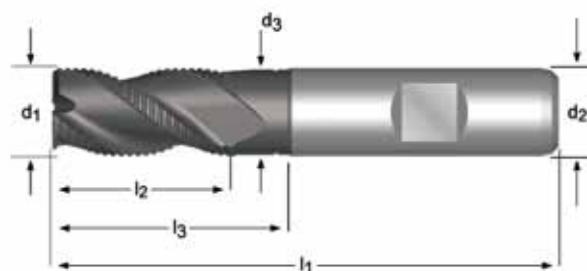

C922



6.00 - 40.00

d_1 Ø mm	d_2 Ø _{h6} mm	l_2 mm	l_1 mm	z	l_3 mm	d_3 Ø mm	C922
6.00	6	13	57	3	-	-	C9226.0
7.00	10	16	66	3	-	-	C9227.0
8.00	10	19	69	3	-	-	C9228.0
9.00	10	19	69	3	-	-	C9229.0
10.00	10	22	72	3	31.5	9.5	C92210.0
11.00	12	22	79	3	-	-	C92211.0
12.00	12	26	83	3	37.5	11.5	C92212.0
13.00	12	26	83	3	37.5	11.5	C92213.0
14.00	12	26	83	3	37.5	11.5	C92214.0
15.00	12	26	83	3	37.5	11.5	C92215.0
16.00	16	32	92	3	43.5	15.5	C92216.0
18.00	16	32	92	3	43.5	15.5	C92218.0
20.00	20	38	104	3	53.5	19.5	C92220.0
22.00	20	38	104	3	53.5	19.5	C92222.0
24.00	25	45	121	4	64.5	23.5	C92224.0
25.00	25	45	121	4	64.5	24.5	C92225.0
26.00	25	45	121	4	64.5	24.5	C92226.0
28.00	25	45	121	4	64.5	24.5	C92228.0
30.00	25	45	121	4	64.5	24.5	C92230.0
32.00	32	53	133	4	72.5	31.5	C92232.0
36.00	32	53	133	4	72.5	31.0	C92236.0
40.00	40	63	155	4	84.5	39.0	C92240.0

C428



- 粗切立铣刀
- Fresa de Topo para Desbaste
- Fresas Gran Desbaste
- Roughing End Mill

C428

C428	▪	1.4	1.5	1.6	2.1	2.2	2.3	3.1	3.2	3.3	3.4	4.2	4.3	5.2	5.3	6.2	7.4
	•	1.3	4.1	5.1	6.4												

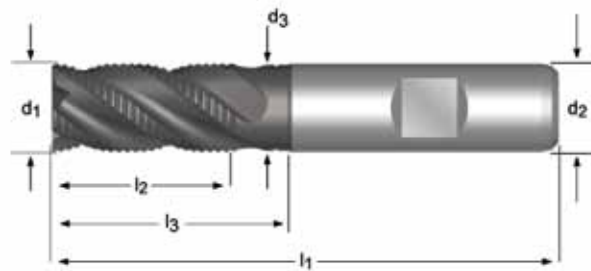

d_1 Ø mm	d_2 Ø _{h6} mm	l_2 mm	l_1 mm	z	l_3 mm	d_3 Ø mm	C428
6.00	6	13	57	4	-	-	C4286.0
7.00	10	16	66	4	-	-	C4287.0
8.00	10	19	69	4	-	-	C4288.0
9.00	10	19	69	4	-	-	C4289.0
10.00	10	22	72	4	31.5	9.5	C42810.0
11.00	12	22	79	4	-	-	C42811.0
12.00	12	26	83	4	37.5	11.5	C42812.0
13.00	12	26	83	4	37.5	11.5	C42813.0
14.00	12	26	83	4	37.5	11.5	C42814.0
15.00	12	26	83	4	37.5	11.5	C42815.0
16.00	16	32	92	4	43.5	15.5	C42816.0
18.00	16	32	92	4	43.5	15.5	C42818.0
20.00	20	38	104	4	53.5	19.5	C42820.0
22.00	20	38	104	4	53.5	19.5	C42822.0
25.00	25	45	121	6	64.5	24.5	C42825.0
28.00	25	45	121	6	64.5	24.5	C42828.0
30.00	25	45	121	6	64.5	24.5	C42830.0
32.00	32	53	133	6	72.5	31.5	C42832.0
36.00	32	53	133	6	72.5	31.0	C42836.0
40.00	40	63	155	6	84.5	39.0	C42840.0

C492



- 粗切立铣刀
- Fresa de Topo para Desbaste
- Fresas Gran Desbaste
- Roughing End Mill

C492

C492	▪	1.3	1.4	1.5	1.6	2.1	2.2	2.3	3.1	3.2	3.3	3.4	4.2	4.3	5.2	5.3	6.2	7.4
	•	4.1	5.1	6.4														

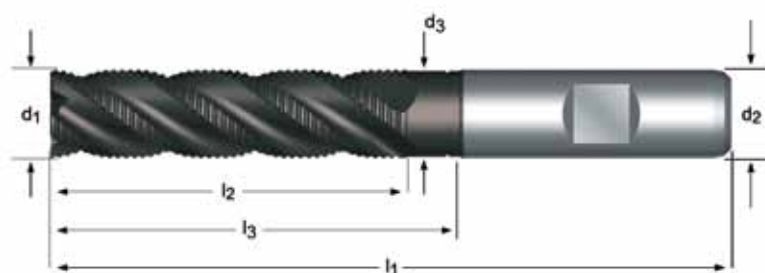

d_1 Ø mm	d_2 Ø _{h6} mm	l_2 mm	l_1 mm	z	l_3 mm	d_3 Ø mm	C492
6.00	6	24	68	3	-	-	C4926.0
8.00	10	38	88	3	-	-	C4928.0
10.00	10	45	95	4	54.5	9.5	C49210.0
12.00	12	53	110	4	64.5	11.5	C49212.0
14.00	12	53	110	4	64.5	11.5	C49214.0
16.00	16	63	123	4	74.5	15.5	C49216.0
18.00	16	63	123	4	74.5	15.5	C49218.0
20.00	20	75	141	4	90.5	19.5	C49220.0
22.00	20	75	141	4	90.5	19.5	C49222.0
25.00	25	90	166	6	109.5	24.5	C49225.0
30.00	25	90	166	6	109.5	24.5	C49230.0

C407 HSS-E PM NRA Z 4-6 $\lambda 35^\circ$ $\gamma 12^\circ$ DIN 1835B k12 DIN 844K

C908 HSS-E PM NRA Z 4-6 $\lambda 35^\circ$ $\gamma 12^\circ$ DIN 1835B Alcrona k12 DIN 844K

- C407**
- 粗切立铣刀
 - Fresa de Topo para Desbaste
- C908**
- Fresas Gran Desbaste
 - Roughing End Mill

C407	▪	1.2	1.3	1.4	1.5	2.1	2.3	3.1	3.2	3.3	3.4	4.2	4.3	5.2	5.3	6.2
	•	1.1	1.6	2.2	4.1	5.1	6.4	7.4								
C908	▪	1.3	1.4	1.5	2.1	2.2	2.3	3.1	3.2	3.3	3.4	4.2	4.3	5.2	5.3	6.2
	•	1.6	4.1	5.1	6.4	7.4										

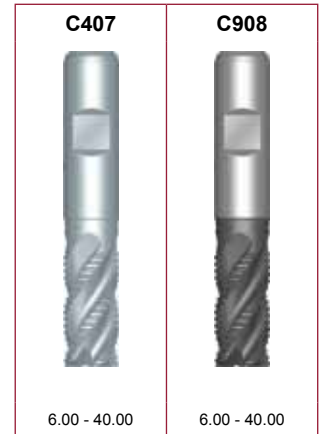
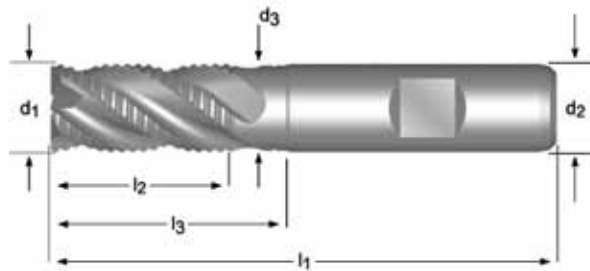

d_1 Ø mm	d_2 Ø _{h6} mm	l_2 mm	l_1 mm	z	l_3 mm	d_3 Ø mm	C407	C908
6.00	6	13	57	4	-	-	C4076.0	C9086.0
7.00	10	16	66	4	-	-	C4077.0	C9087.0
8.00	10	19	69	4	-	-	C4078.0	C9088.0
9.00	10	19	69	4	-	-	C4079.0	C9089.0
10.00	10	22	72	4	31.5	9.5	C40710.0	C90810.0
11.00	12	22	79	4	-	-	C40711.0	C90811.0
12.00	12	26	83	4	37.5	11.5	C40712.0	C90812.0
13.00	12	26	83	4	37.5	11.5	C40713.0	C90813.0
14.00	12	26	83	4	37.5	11.5	C40714.0	C90814.0
15.00	12	26	83	4	37.5	11.5	C40715.0	C90815.0
16.00	16	32	92	4	43.5	15.5	C40716.0	C90816.0
18.00	16	32	92	4	43.5	15.5	C40718.0	C90818.0
20.00	20	38	104	4	53.5	19.5	C40720.0	C90820.0
22.00	20	38	104	4	53.5	19.5	C40722.0	C90822.0
25.00	25	45	121	6	64.5	24.5	C40725.0	C90825.0
28.00	25	45	121	6	64.5	24.5	C40728.0	C90828.0
30.00	25	45	121	6	64.5	24.5	C40730.0	C90830.0
32.00	32	53	133	6	72.5	31.5	C40732.0	C90832.0
36.00	32	53	133	6	72.5	31.0		C90836.0
40.00	40	63	155	6	84.5	39.0	C40740.0	C90840.0

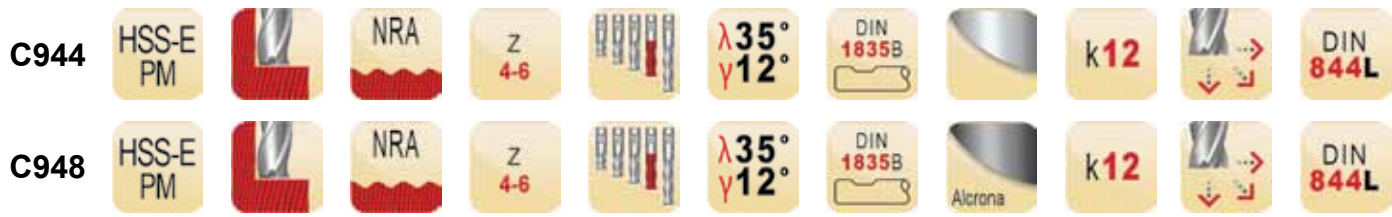

- C944**
- 粗切立铣刀
 - Fresa de Topo para Desbaste
- C948**
- Fresas Gran Desbaste
 - Roughing End Mill

C944	▪	1.3	1.4	1.5	2.1	2.3	3.1	3.2	3.3	3.4	4.2	4.3	5.2	5.3	6.2	7.4		
	•	1.6	2.2	4.1	5.1	6.4												
C948	▪	1.3	1.4	1.5	1.6	2.1	2.2	2.3	3.1	3.2	3.3	3.4	4.2	4.3	5.2	5.3	6.2	7.4
	•	4.1	5.1	6.4														

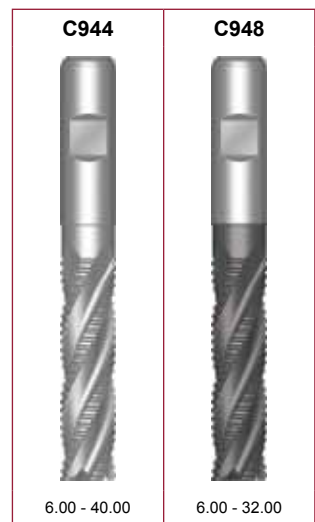
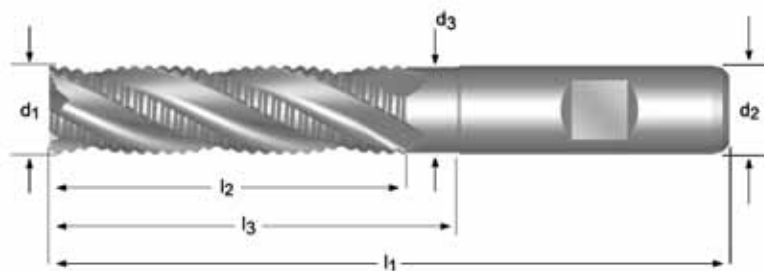

d_1 Ø mm	d_2 Ø _{h6} mm	l_2 mm	l_1 mm	z	l_3 mm	d_3 Ø mm	C944	C948
6.00	6	24	68	4	-	-	C9446.0	C9486.0
8.00	10	38	88	4	-	-	C9448.0	C9488.0
10.00	10	45	95	4	54.5	9.5	C94410.0	C94810.0
12.00	12	53	110	4	64.5	11.5	C94412.0	C94812.0
14.00	12	53	110	4	64.5	11.5	C94414.0	C94814.0
16.00	16	63	123	4	74.5	15.5	C94416.0	C94816.0
18.00	16	63	123	4	74.5	15.5		C94818.0
20.00	20	75	141	4	90.5	19.5	C94420.0	C94820.0
25.00	25	90	166	6	109.5	24.5	C94425.0	C94825.0
30.00	25	90	166	6	109.5	24.5		C94830.0
32.00	32	106	186	6	125.5	31.5	C94432.0	C94832.0
40.00	40	125	217	6	-	-	C94440.0	

C921



- 粗切立铣刀
- Fresa de Topo para Desbaste
- Fresas Gran Desbaste
- Roughing End Mill

C921

C921	▪	1.3	1.4	1.5	1.6	2.1	2.2	2.3	3.1	3.2	3.3	3.4	4.2	4.3	5.2	5.3	6.2	7.4
	•	4.1	5.1	6.4														

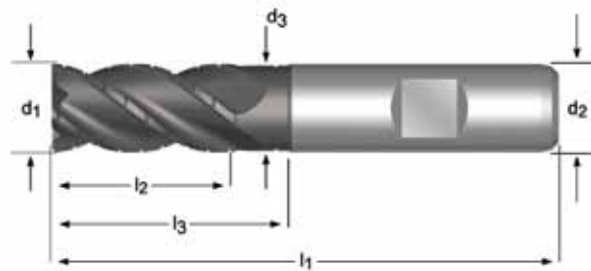

d_1 Ø mm	d_2 Ø _{h6} mm	l_2 mm	l_1 mm	z	l_3 mm	d_3 Ø mm	C921
6.00	6	13	57	3	-	-	C9216.0
8.00	10	19	69	4	-	-	C9218.0
10.00	10	22	72	4	31.5	9.5	C92110.0
12.00	12	26	83	4	37.5	11.5	C92112.0
14.00	12	26	83	4	37.5	11.5	C92114.0
16.00	16	32	92	4	43.5	15.5	C92116.0
18.00	16	32	92	4	43.5	15.5	C92118.0
20.00	20	38	104	4	53.5	19.5	C92120.0
22.00	20	38	104	5	53.5	19.5	C92122.0
25.00	25	45	121	5	64.5	24.5	C92125.0
28.00	25	45	121	6	64.5	24.5	C92128.0
30.00	25	45	121	6	64.5	24.5	C92130.0
32.00	32	53	133	6	72.5	31.5	C92132.0



- C400**
- 粗切立铣刀
 - Fresa de Topo para Desbaste
- C413**
- Fresas Gran Desbaste
 - Roughing End Mill

C400	▪	1.2	1.3	6.2	6.3														
	•	1.1	1.4	2.1	3.1	3.2	3.3	3.4	4.1	4.2	5.1	5.2	6.1	7.2	7.3	8.1			
C413	▪	1.2	1.3	1.4	3.1	3.2	3.3	3.4	4.2	5.2	6.2	6.3							
	•	1.1	1.5	1.6	2.1	2.3	4.1	4.3	5.1	5.3	6.1	6.4	7.2	7.3	7.4	8.1			

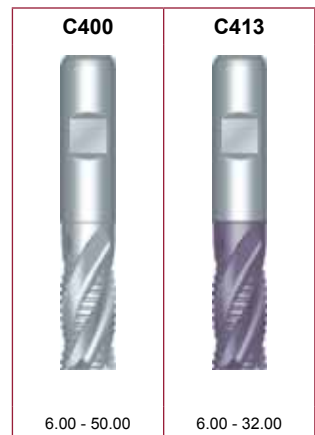
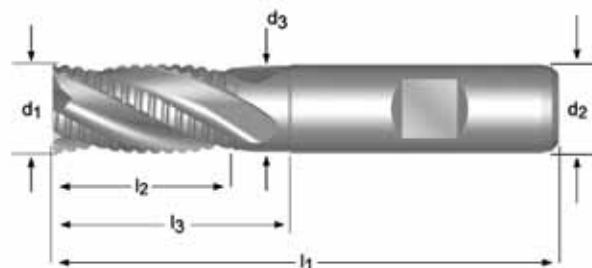

d_1 Ø mm	d_2 Ø _{h6} mm	l_2 mm	l_1 mm	z	l_3 mm	d_3 Ø mm	C400	C413
6.00	6	13	57	4	-	-	C4006.0	C4136.0
7.00	10	16	66	4	-	-	C4007.0	
8.00	10	19	69	4	-	-	C4008.0	C4138.0
9.00	10	19	69	4	-	-	C4009.0	
10.00	10	22	72	4	-	-	C40010.0	C41310.0
11.00	12	22	79	4	-	-	C40011.0	
12.00	12	26	83	4	-	-	C40012.0	C41312.0
13.00	12	26	83	4	37.5	11.5	C40013.0	
14.00	12	26	83	4	37.5	11.5	C40014.0	C41314.0
15.00	12	26	83	4	37.5	11.5	C40015.0	
16.00	16	32	92	4	43.5	15.5	C40016.0	C41316.0
18.00	16	32	92	4	43.5	15.5	C40018.0	C41318.0
20.00	20	38	104	4	53.5	19.5	C40020.0	C41320.0
22.00	20	38	104	4	53.5	19.5	C40022.0	C41322.0
25.00	25	45	121	5	64.5	24.5	C40025.0	C41325.0
26.00	25	45	121	5	64.5	24.5	C40026.0	
28.00	25	45	121	5	64.5	24.5	C40028.0	C41328.0
30.00	25	45	121	5	64.5	24.5	C40030.0	C41330.0
32.00	32	53	133	6	72.5	31.0	C40032.0	C41332.0
40.00	40	63	155	6	84.5	39.0	C40040.0	
50.00	50	75	177	6	96.5	48.0	C40050.0	

C403	HSS-E		NF	Z 4-6		$\lambda 30^\circ$ $\gamma 12^\circ$	DIN 1835B		k12		DIN 844L
C429	HSS-E		NF	Z 4-6		$\lambda 30^\circ$ $\gamma 12^\circ$	DIN 1835B	TiCN	k12		DIN 844L

- C403**
- 粗切立铣刀
 - Fresa de Topo para Desbaste
- C429**
- Fresas Gran Desbaste
 - Roughing End Mill

C403	▪	1.2	1.3	6.2	6.3											
	•	1.1	1.4	2.1	3.1	3.2	3.3	3.4	4.1	4.2	5.1	5.2	6.1	7.2	7.3	8.1
C429	▪	1.2	1.3	1.4	3.1	3.2	3.3	3.4	4.2	5.2	6.2	6.3				
	•	1.1	1.5	1.6	2.1	2.3	4.1	4.3	5.1	5.3	6.1	6.4	7.2	7.3	7.4	8.1

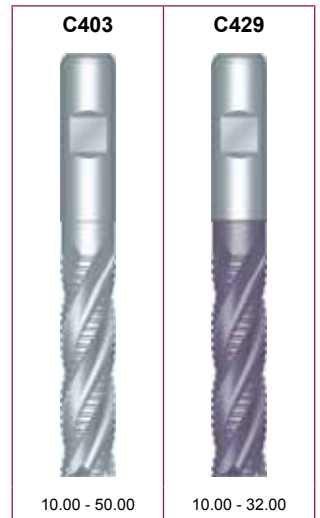
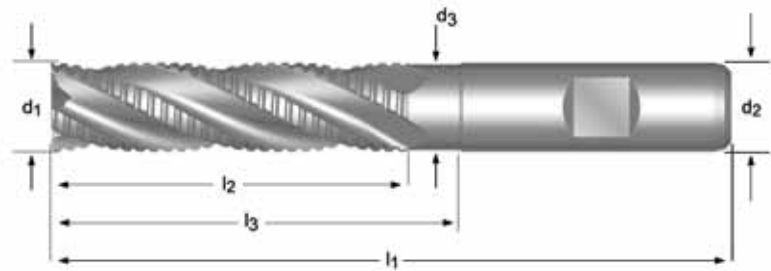

d_1 Ø mm	d_2 Ø _{h6} mm	l_2 mm	l_1 mm	z	l_3 mm	d_3 Ø mm	C403	C429
10.00	10	45	95	4	-	-	C40310.0	C42910.0
12.00	12	53	110	4	-	-	C40312.0	C42912.0
14.00	12	53	110	4	64.5	11.5	C40314.0	C42914.0
16.00	16	63	123	4	74.5	15.5	C40316.0	C42916.0
18.00	16	63	123	4	74.5	15.5	C40318.0	C42918.0
20.00	20	75	141	4	90.5	19.5	C40320.0	C42920.0
22.00	20	75	141	4	90.5	19.5	C40322.0	
25.00	25	90	166	5	109.5	24.5	C40325.0	C42925.0
30.00	25	90	166	5	109.5	24.5	C40330.0	C42930.0
32.00	32	106	186	6	125.5	31.0	C40332.0	C42932.0
36.00	32	106	186	6	125.5	31.5	C40336.0	
40.00	40	125	217	6	146.5	39.0	C40340.0	
45.00	40	125	217	6	146.5	39.5	C40345.0	
50.00	50	150	252	6	171.5	48.0	C40350.0	



- C500** • 球头立铣刀
• Fresa de topo esférico
- C503** • Fresas con punta esferica
• Ball-Nosed End Mill

C500	▪	1.1	1.2	4.1	5.1	6.1	6.2	6.3												
	•	1.3	1.4	2.1	3.1	3.2	3.3	3.4	4.2	5.2	7.1	7.2	7.3	8.1						
C503	▪	1.1	1.2	1.3	1.4	3.1	3.2	3.3	3.4	4.1	4.2	5.1	5.2	6.1	6.2	6.3				
	•	1.5	1.6	2.1	2.3	4.3	5.3	6.4	7.1	7.2	7.3	7.4	8.1							

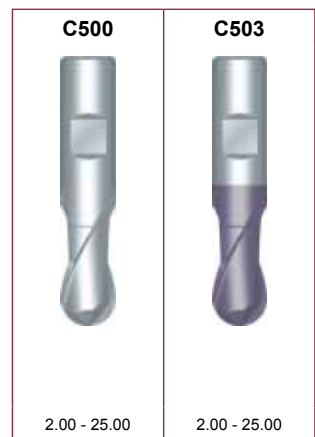
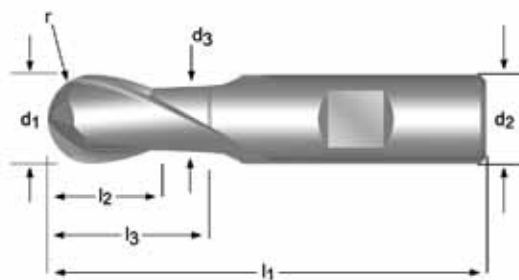

d_1 Ø mm	r ±0.05 mm	d_2 Ø _{h6} mm	l_2 mm	l_1 mm	z	l_3 mm	d_3 Ø mm	C500	C503
2.00	1.00	6	4	48	2	-	-	C5002.0	C5032.0
3.00	1.50	6	5	49	2	-	-	C5003.0	C5033.0
4.00	2.00	6	7	51	2	-	-	C5004.0	C5034.0
5.00	2.50	6	8	52	2	-	-	C5005.0	C5035.0
6.00	3.00	6	8	52	2	-	-	C5006.0	C5036.0
7.00	3.50	10	10	60	2	-	-	C5007.0	C5037.0
8.00	4.00	10	11	61	2	-	-	C5008.0	C5038.0
9.00	4.50	10	11	61	2	-	-	C5009.0	C5039.0
10.00	5.00	10	13	63	2	-	-	C50010.0	C50310.0
11.00	5.50	12	13	70	2	-	-	C50011.0	C50311.0
12.00	6.00	12	16	73	2	-	-	C50012.0	C50312.0
13.00	6.50	12	16	73	2	27.5	11.5	C50013.0	C50313.0
14.00	7.00	12	16	73	2	27.5	11.5	C50014.0	C50314.0
15.00	7.50	12	16	73	2	27.5	11.5	C50015.0	C50315.0
16.00	8.00	16	19	79	2	30.5	15.5	C50016.0	C50316.0
18.00	9.00	16	19	79	2	30.5	15.5	C50018.0	C50318.0
20.00	10.00	20	22	88	2	37.5	19.5	C50020.0	C50320.0
25.00	12.50	25	26	102	2	45.5	24.5	C50025.0	C50325.0

C505



- 球头立铣刀
- Fresa de topo esférico
- Fresas con punta esférica
- Ball-Nosed End Mill

C505

C505	▪	1.1	1.2	4.1	5.1	6.1	6.2	6.3						
	•	1.3	1.4	2.1	3.1	3.2	3.3	3.4	4.2	5.2	7.1	7.2	7.3	8.1

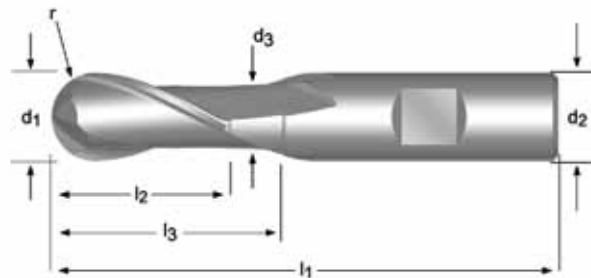

d ₁ ∅ mm	r ±0.05 mm	d ₂ ∅h ₆ mm	l ₂ mm	l ₁ mm	z	l ₃ mm	d ₃ ∅ mm	C505
3.00	1.50	6	8	52	2	-	-	C5053.0
4.00	2.00	6	11	55	2	-	-	C5054.0
5.00	2.50	6	13	57	2	-	-	C5055.0
6.00	3.00	6	13	57	2	-	-	C5056.0
8.00	4.00	10	19	69	2	-	-	C5058.0
10.00	5.00	10	22	72	2	-	-	C50510.0
12.00	6.00	12	26	83	2	-	-	C50512.0
14.00	7.00	12	26	83	2	37.5	11.5	C50514.0
16.00	8.00	16	32	92	2	43.5	15.5	C50516.0
20.00	10.00	20	38	104	2	53.5	19.5	C50520.0
22.00	11.00	20	38	104	2	53.5	19.5	C50522.0
25.00	12.50	25	45	121	2	64.5	24.5	C50525.0
28.00	14.00	25	45	121	2	64.5	24.5	C50528.0
30.00	15.00	25	45	121	2	64.5	24.5	C50530.0

C511



- 球头立铣刀
- Fresa de topo esférico
- Fresas con punta esferica
- Ball-Nosed End Mill

C511

C511	▪	1.1	1.2	4.1	5.1	6.1	6.2	6.3											
	•	1.3	1.4	2.1	3.1	3.2	3.3	3.4	4.2	5.2	7.1	7.2	7.3	8.1					

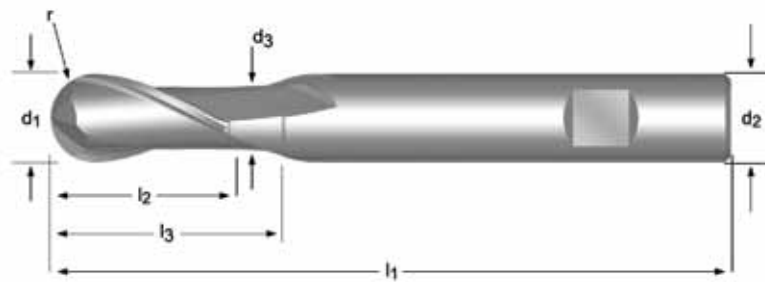

d_1 Ø mm	r ±0.05 mm	d_2 Ø _{h6} mm	l_2 mm	l_1 mm	z	l_3 mm	d_3 Ø mm	C511
3.00	1.50	6	8	56	2	-	-	C5113.0
4.00	2.00	6	11	63	2	-	-	C5114.0
5.00	2.50	6	13	68	2	-	-	C5115.0
6.00	3.00	6	13	68	2	-	-	C5116.0
8.00	4.00	10	19	88	2	-	-	C5118.0
10.00	5.00	10	22	95	2	-	-	C51110.0
12.00	6.00	12	26	110	2	-	-	C51112.0
14.00	7.00	12	26	110	2	64.5	11.5	C51114.0
16.00	8.00	16	32	123	2	74.5	15.5	C51116.0
18.00	9.00	16	32	123	2	74.5	15.5	C51118.0
20.00	10.00	20	38	141	2	90.5	19.5	C51120.0
25.00	12.50	25	45	166	2	109.5	24.5	C51125.0

C800

HSS-E

N
Z 6-8
 $\lambda 15^\circ$
 $\gamma 10^\circ$
DIN 1835

d11

DIN 851

C800

- T-形槽铣刀
- Fresa p/ Abrir Rasgos T
- Fresas de ranurar en "T"
- T-slot Cutter

C800	1.1	1.2	1.3	1.4	1.5	1.6	2.1	2.2	2.3	3.1	3.2	3.3	3.4	4.1	4.2	4.3	5.1	5.2	5.3	6.1
	6.2	6.3	6.4	7.1	7.2	7.3	7.4	8.1	10.1											

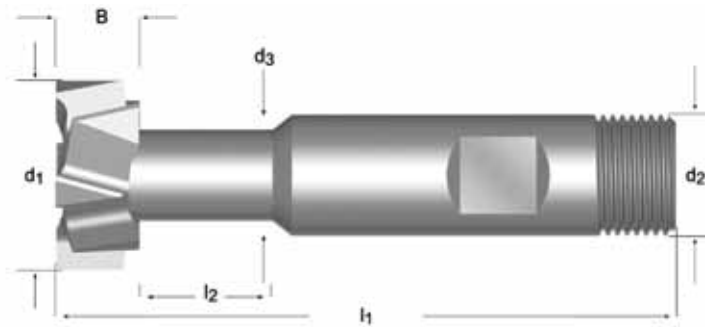

B	d ₁ Ø	T DIN650	d ₃ Ø	l ₂	l ₁	d ₂ Øh ₆ mm	z	C800
4.0	11.00	5	4	6.5	53.5	10	6	C80011.0X5.0
6.0	12.50	6	5	9	57.0	10	6	C80012.5X6.0
8.0	16.00	8	7	12	62.0	10	6	C80016.0X8.0
8.0	18.00	10	8	15	70.0	12	6	C80018.0X10.0
9.0	21.00	12	10	18	74.0	12	8	C80021.0X12.0
11.0	25.00	14	12	20	82.0	16	8	C80025.0X14.0
14.0	32.00	18	15	26	90.0	16	8	C80032.0X18.0
18.0	40.00	22	19	27	108.0	25	8	C80040.0X22.0
22.0	50.00	28	25	34	124.0	32	8	C80050.0X28.0

C810

HSS



N

Z

6-8

λ 12°
 γ 10°

DIN 1835D



d11



DORMER

- T-形槽铣刀
- Fresa p/ Abrir Rasgos T
- Fresas de ranurar en "T"
- T-slot Cutter

C810

C810	▪	1.1	1.2	1.3	1.4	2.1	3.1	3.2	3.3	3.4	4.1	5.1	6.1	6.2	6.3	6.4	7.1	7.2	7.3	
	•	1.5	1.6	2.2	2.3	4.2	4.3	5.2	5.3	7.4	8.1	10.1								

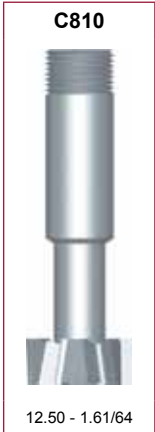
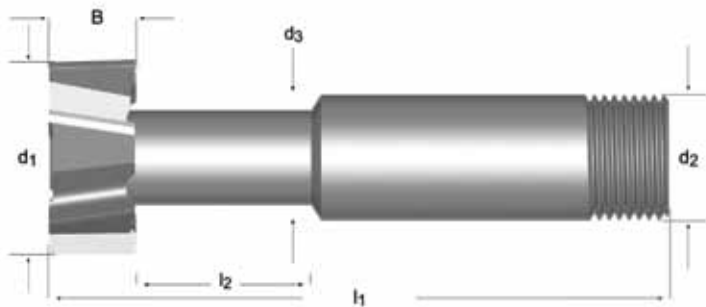

B	B	d ₁	d ₁	T	d ₃	l ₂	l ₁	d ₂	d ₂	z	C810
Inch	mm	Inch	mm	DIN650	mm	mm	mm	Inch	mm		
	6.00		12.50	6.0	5.00	11	57.0		10.0	6	C8106.0
1/4	6.35	37/64	14.68	1/4	6.35	14	60.5	1/2	12.7	6	C8101/4
	8.00		16.00	8.0	7.00	13	61.0		10.0	6	C8108.0
5/16	7.94	45/64	17.86	5/16	7.15	17	65.0	1/2	12.7	6	C8105/16
	8.00		18.00	10.0	8.00	17	65.0		12.0	6	C81010.0
	9.00		21.00	12.0	10.00	20	69.0		12.0	6	C81012.0
23/64	9.13	53/64	21.03	3/8	8.75	19	68.5	1/2	12.7	6	C8103/8
27/64	10.72	61/64	24.21	7/16	9.50	22	73.0	1/2	12.7	6	C8107/16
	11.00		25.00	14.0	12.00	23	79.0		16.0	6	C81014.0
15/32	11.91	1.5/64	27.38	1/2	11.90	24	76.0	1/2	12.7	6	C8101/2
	12.00		28.00	16.0	13.00	23	76.0		16.0	6	C81016.0
37/64	14.68	1.21/64	33.73	5/8	14.30	30	101.5	1"	25.4	8	C8105/8
	14.00		32.00	18.0	15.00	27	98.0		25.0	8	C81018.0
	16.00		36.00	20.0	17.00	30	100.0		25.0	8	C81020.0
11/16	17.46	1.33/64	38.50	3/4	17.45	35	109.5	1"	25.4	8	C8103/4
	18.00		40.00	22.0	19.00	33	108.0		25.0	8	C81022.0
51/64	20.24	1.45/64	43.26	7/8	20.65	40	117.5	1"	25.4	8	C8107/8
29/32	23.02	1.61/64	49.61	1"	23.80	47	127.0	1"	25.4	8	C8101

C825



C825

- T-形槽铣刀
- Fresa p/ Abrir Rasgos T
- Fresas de ranurar en "T"
- T-slot Cutter

C825	1.1	1.2	1.3	1.4	1.5	1.6	2.1	2.2	2.3	3.1	3.2	3.3	3.4	4.1	4.2	4.3	5.1	5.2	5.3	6.1	
	6.2	6.3	6.4	7.1	7.2	7.3	7.4	8.1	10.1												

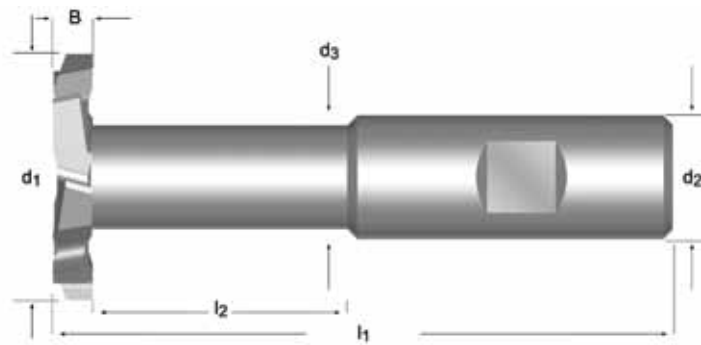

B	d ₁ Ø	d ₃ Ø	l ₂	l ₁	d ₂ Øh ₆	z	C825
mm	mm	mm	mm	mm	mm		
3	40	19.2	46	100	20	8	C8253.0X40.0
4	40	19.2	45	100	20	8	C8254.0X40.0
5	40	19.2	44	100	20	8	C8255.0X40.0
6	40	19.2	43	100	20	8	C8256.0X40.0
8	40	19.2	41	100	20	8	C8258.0X40.0
10	40	19.2	39	100	20	8	C82510.0X40.0
6	63	24.2	67	130	25	12	C8256.0X63.0
8	63	24.2	65	130	25	12	C8258.0X63.0
10	63	24.2	63	130	25	12	C82510.0X63.0
12	63	24.2	61	130	25	12	C82512.0X63.0
14	63	24.2	59	130	25	12	C82514.0X63.0
16	63	24.2	57	130	25	12	C82516.0X63.0
18	63	24.2	55	130	25	12	C82518.0X63.0

C801



C801

- T-形槽铣刀
- Fresa p/ Abrir Rasgos T
- Fresas de ranurar en "T"
- T-slot Cutter

C801	1.1	1.2	1.3	1.4	1.5	1.6	2.1	2.2	2.3	3.1	3.2	3.3	3.4	4.1	4.2	4.3	5.1	5.2	5.3	6.1	
	6.2	6.3	6.4	7.1	7.2	7.3	7.4	8.1	10.1												

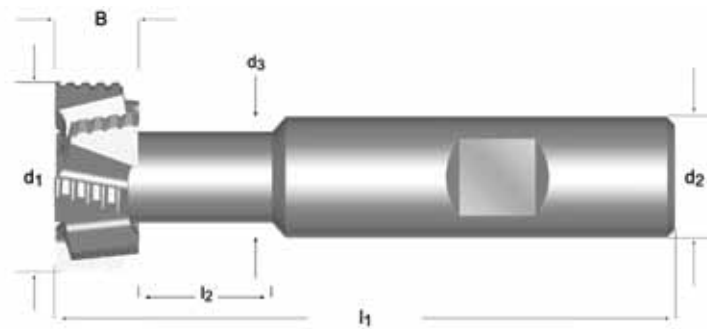

B	d ₁ Ø	T DIN650	d ₃ Ø	l ₂	l ₁	d ₂ Øh ₆	z	C801
8.0	16.0	8	7	10	62	10	6	C80116.0X8.0
8.0	18.0	10	8	13	70	12	6	C80118.0X10.0
9.0	21.0	12	10	16	74	12	6	C80121.0X12.0
11.0	25.0	14	12	17	82	16	8	C80125.0X14.0
14.0	32.0	18	15	22	90	16	8	C80132.0X18.0

C822



- 半圆键槽铣刀
- Fresas para ranhurados tipo Woodruff
- Fresas para ranurados tipo Woodruff
- Woodruff Cutter

C822

C822	1.1	1.2	1.3	1.4	1.5	1.6	2.1	2.2	2.3	3.1	3.2	3.3	3.4	4.1	4.2	4.3	5.1	5.2	5.3	6.1	
	6.2	6.3	6.4	7.1	7.2	7.3	7.4	8.1	10.1												

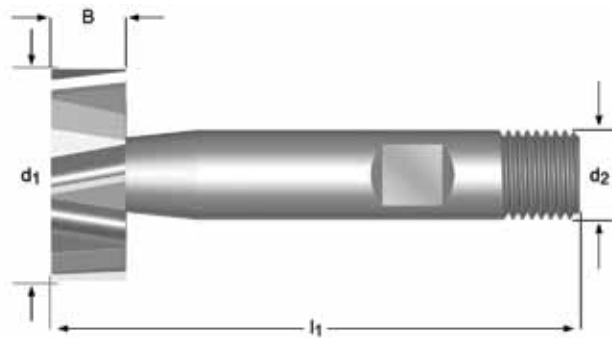

B	d ₁ Ø	l ₁	d ₂ Øh ₆	z	C822
mm	mm	mm	mm		
1.0	4.50	50	6	6	C8224.5X1.0
1.5	7.50	50	6	6	C8227.5X1.5
2.0	7.50	50	6	6	C8227.5X2.0
2.0	10.50	50	6	8	C82210.5X2.0
2.5	10.50	50	6	8	C82210.5X2.5
3.0	10.50	50	6	8	C82210.5X3.0
3.0	13.50	56	10	8	C82213.5X3.0
4.0	13.50	56	10	8	C82213.5X4.0
3.0	16.50	56	10	8	C82216.5X3.0
4.0	16.50	56	10	8	C82216.5X4.0
5.0	16.50	56	10	8	C82216.5X5.0
3.0	19.50	63	10	6	C82219.5X3.0
4.0	19.50	63	10	10	C82219.5X4.0
5.0	19.50	63	10	10	C82219.5X5.0
5.0	22.50	63	10	10	C82222.5X5.0
6.0	22.50	63	10	10	C82222.5X6.0
8.0	22.50	63	10	10	C82222.5X8.0
6.0	25.50	63	10	12	C82225.5X6.0
6.0	28.50	63	10	12	C82228.5X6.0
8.0	28.50	63	10	12	C82228.5X8.0
10.0	28.50	71	12	12	C82228.5X10.0
8.0	32.50	71	12	12	C82232.5X8.0
10.0	32.50	71	12	12	C82232.5X10.0
10.0	45.50	71	12	12	C82245.5X10.0

C820

HSS



N

Z

6-12



- 半圆键槽铣刀
- Fresa Woodruff
- Fresas para ranurados tipo Woodruff
- Woodruff Cutter

C820

C820	▪	1.1	1.2	1.3	1.4	2.1	2.2	3.1	3.2	3.3	3.4	4.1	5.1	6.1	6.2	6.3	7.1	7.2	7.3	
	•	1.5	1.6	2.3	4.2	4.3	5.2	5.3	6.4	7.4	8.1	10.1								

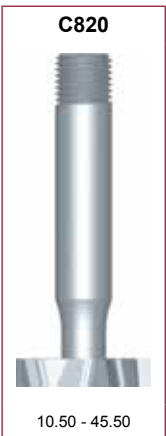
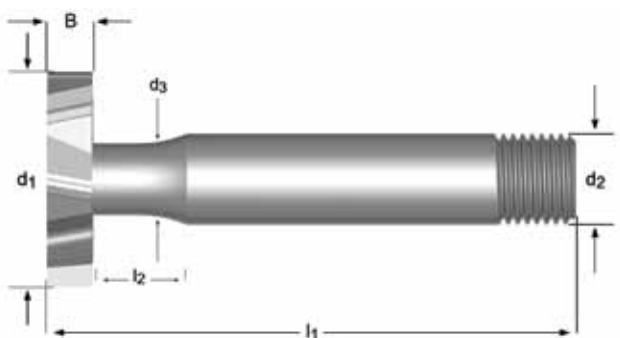

Nr.	B Inch	B mm	d ₁ Ø Inch	d ₁ Ø mm	d ₃ Ø mm	l ₂ mm	l ₁ mm	d ₂ Ø Inch	d ₂ Ø0,-0.025 mm	z	C820
		2.00		10.50	3.90	10	57.0		12.0	6	C82010.5X2.0
		2.50		10.50	3.90	10	57.0		12.0	6	C82010.5X2.5
		3.00		10.50	4.20	10	57.0		12.0	6	C82010.5X3.0
204	1/16	1.59	1/2	12.70	3.30	10	57.0	1/2	12.7	6	C820204
304	3/32	2.38	1/2	12.70	4.05	10	57.0	1/2	12.7	6	C820304
404	1/8	3.18	1/2	12.70	4.85	10	57.0	1/2	12.7	6	C820404
		2.00		13.50	4.00	10	57.0		12.0	6	C82013.5X2.0
		2.50		13.50	4.00	10	57.0		12.0	6	C82013.5X2.5
		3.00		13.50	5.00	10	57.0		12.0	6	C82013.5X3.0
		4.00		13.50	5.00	10	57.0		12.0	6	C82013.5X4.0
305	3/32	2.38	5/8	15.88	4.85	10	57.0	1/2	12.7	6	C820305
405	1/8	3.18	5/8	15.88	5.65	10	57.0	1/2	12.7	6	C820405
505	5/32	3.97	5/8	15.88	6.35	10	57.0	1/2	12.7	6	C820505
		2.50		16.50	4.00	10	57.0		12.0	6	C82016.5X2.5
		3.00		16.50	5.00	10	57.0		12.0	6	C82016.5X3.0
		4.00		16.50	5.00	10	57.0		12.0	6	C82016.5X4.0
		5.00		16.50	5.60	10	57.0		12.0	6	C82016.5X5.0
406	1/8	3.18	3/4	19.05	5.50	10	57.0	1/2	12.7	6	C820406
506	5/32	3.97	3/4	19.05	6.35	10	57.0	1/2	12.7	6	C820506
606	3/16	4.76	3/4	19.05	7.15	10	57.0	1/2	12.7	6	C820606
		3.00		19.50	5.60	10	57.0		12.0	6	C82019.5X3.0
		4.00		19.50	5.60	10	57.0		12.0	6	C82019.5X4.0
		5.00		19.50	6.00	10	57.0		12.0	6	C82019.5X5.0
507	5/32	3.97	7/8	22.23	6.35	10	63.5	1/2	12.7	8	C820507
607	3/16	4.76	7/8	22.23	7.15	10	63.5	1/2	12.7	8	C820607
707	7/32	5.56	7/8	22.23	7.95	10	63.5	1/2	12.7	8	C820707
807	1/4	6.35	7/8	22.23	8.75	10	63.5	1/2	12.0	8	C820807
		4.00		22.50	5.60	10	63.5		12.0	8	C82022.5X4.0
		5.00		22.50	6.00	10	63.5		12.0	8	C82022.5X5.0
		6.00		22.50	6.50	10	63.5		12.0	8	C82022.5X6.0
608	3/16	4.76	1"	25.40	7.15	10	70.0	1/2	12.7	8	C820608
708	7/32	5.56	1"	25.40	7.95	10	70.0	1/2	12.7	8	C820708
808	1/4	6.35	1"	25.40	8.75	10	70.0	1/2	12.7	8	C820808
1008	5/16	7.94	1"	25.40	10.30	10	70.0	1/2	12.7	8	C8201008
		5.00		25.50	7.50	10	70.0		12.0	8	C82025.5X5.0
		6.00		25.50	7.50	10	70.0		12.0	8	C82025.5X6.0
		7.00		25.50	8.00	10	70.0		12.0	8	C82025.5X7.0
		8.00		25.50	8.00	10	70.0		12.0	8	C82025.5X8.0

Nr.	B Inch	B mm	d ₁ Ø Inch	d ₁ Ø mm	d ₃ Ø mm	l ₂ mm	l ₁ mm	d ₂ Ø Inch	d ₂ Ø0,-0.025 mm	z	C820
		5.00		28.50	8.00	12	70.0		12.0	8	C82028.5X5.0
		6.00		28.50	8.50	12	70.0		12.0	8	C82028.5X6.0
		7.00		28.50	8.50	12	70.0		12.0	8	C82028.5X7.0
		8.00		28.50	9.00	12	70.0		12.0	8	C82028.5X8.0
609	3/16	4.76	1.1/8	28.58	7.95	12	70.0	1/2	12.7	8	C820609
709	7/32	5.56	1.1/8	28.58	8.75	12	70.0	1/2	12.7	8	C820709
809	1/4	6.35	1.1/8	28.58	9.50	12	70.0	1/2	12.7	8	C820809
1009	5/16	7.94	1.1/8	28.58	11.10	12	70.0	1/2	12.7	8	C8201009
610	3/16	4.76	1.1/4	31.75	7.95	12	70.0	1/2	12.7	10	C820610
710	7/32	5.56	1.1/4	31.75	8.75	12	70.0	1/2	12.7	10	C820710
810	1/4	6.35	1.1/4	31.75	9.50	12	70.0	1/2	12.7	10	C820810
1010	5/16	7.94	1.1/4	31.75	11.10	12	70.0	1/2	12.7	10	C8201010
1210	3/8	9.53	1.1/4	31.75	11.95	12	70.0	1/2	12.7	10	C8201210
		5.00		32.50	8.00	12	70.0		12.0	10	C82032.5X5.0
		6.00		32.50	8.50	12	70.0		12.0	10	C82032.5X6.0
		7.00		32.50	8.50	12	70.0		12.0	10	C82032.5X7.0
		8.00		32.50	9.00	12	70.0		12.0	10	C82032.5X8.0
811	1/4	6.35	1.3/8	34.93	11.10	20	76.0	1/2	12.7	10	C820811
1011	5/16	7.94	1.3/8	34.93	11.95	20	76.0	1/2	12.7	10	C8201011
1211	3/8	9.53	1.3/8	34.93	11.95	20	76.0	1/2	12.7	10	C8201211
		6.00		35.50	9.50	20	76.0		12.0	10	C82035.5X6.0
		7.00		35.50	9.50	20	76.0		12.0	10	C82035.5X7.0
		8.00		35.50	11.50	20	76.0		12.0	10	C82035.5X8.0
		9.00		35.50	11.50	20	76.0		12.0	10	C82035.5X9.0
812	1/4	6.35	1.1/2	38.10	11.10	20	76.0	1/2	12.7	10	C820812
1012	5/16	7.94	1.1/2	38.10	11.95	20	76.0	1/2	12.7	10	C8201012
1212	3/8	9.53	1.1/2	38.10	11.95	20	76.0	1/2	12.7	10	C8201212
		7.00		38.50	10.50	20	76.0		12.0	10	C82038.5X7.0
		8.00		38.50	11.50	20	76.0		12.0	10	C82038.5X8.0
		9.00		38.50	11.50	20	76.0		12.0	10	C82038.5X9.0
		10.00		38.50	11.50	20	76.0		12.0	10	C82038.5X10.0
		10.00		45.50	11.50	20	76.0		12.0	12	C82045.5X10.0

C837

HSS



N

Z

6-8



- 燕尾槽铣刀
- Fresa Rabo de Andorinha
- Fresas de cola de milano
- Dovetail Cutter

C837

C837	▪	1.1	1.2	1.3	1.4	2.1	3.1	3.2	3.3	3.4	4.1	5.1	6.1	6.2	6.3	7.1	7.2	7.3	
	•	1.5	1.6	2.2	2.3	4.2	4.3	5.2	5.3	6.4	7.4	8.1							

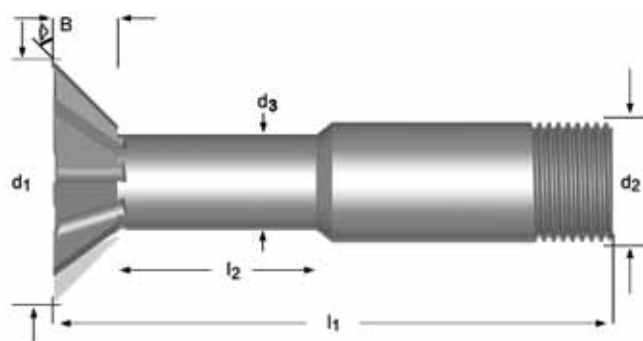

φ	B	d_1 Ø	d_1 Ø	d_3	l_2	l_1	d_2 Ø	d_2 Ø, -0.025	z	C837
	mm	Inch	mm	mm	mm	mm	Inch	mm		
45°	3.0		13.00	4.75	16.5	63.5		12.00	6	C83713.0
45°	4.0	5/8	15.88	6.35	17.5	66.5	1/2	12.70	6	C8375/8
45°	4.0		16.00	6.35	17.5	66.5		12.00	6	C83716.0
45°	5.5		19.00	6.35	16.0	66.5		12.00	6	C83719.0
45°	5.5	3/4	19.05	6.35	16.0	66.5	1/2	12.70	6	C8373/4
45°	6.5		22.00	7.15	16.0	68.5		12.00	6	C83722.0
45°	6.5	7/8	22.23	7.15	16.0	68.5	1/2	12.70	6	C8377/8
45°	7.5		25.00	7.95	16.5	70.0		12.00	6	C83725.0
45°	8.0	1"	25.40	7.95	16.0	70.0	1/2	12.70	6	C8371
45°	8.5		28.00	9.55	17.0	71.5		16.00	6	C83728.0
45°	8.5	1.1/4	31.75	11.10	16.0	74.5	5/8	15.88	8	C8371.1/4
45°	8.5		32.00	11.10	16.0	74.5		16.00	8	C83732.0
45°	9.5	1.3/8	34.93	11.90	16.5	78.0	1"	25.40	8	C8371.3/8
45°	9.5		35.00	11.90	16.5	78.0		25.00	8	C83735.0
45°	10.5		38.00	12.70	16.0	78.5		25.00	8	C83738.0
45°	10.5	1.1/2	38.10	12.70	16.0	78.5	1"	25.40	8	C8371.1/2

C835



- 燕尾槽铣刀
- Fresa Rabo de Andorinha
- Fresas de cola de milano
- Dovetail Cutter

C835

C835	▪	1.1	1.2	1.3	1.4	2.1	3.1	3.2	3.3	3.4	4.1	5.1	6.1	6.2	6.3	7.1	7.2	7.3	
	•	1.5	1.6	2.2	2.3	4.2	4.3	5.2	5.3	6.4	7.4	8.1							

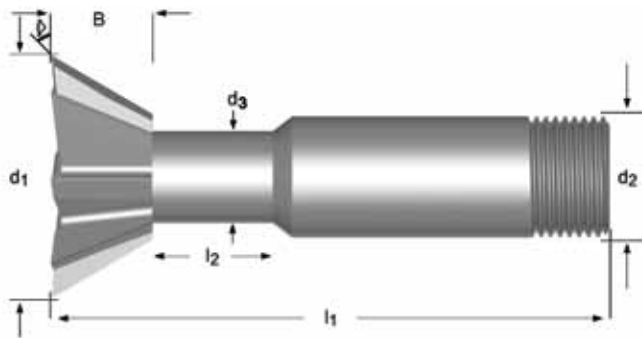

γ	B	d ₁ Ø	d ₁ Ø	d ₃	l ₂	l ₁	d ₂ Ø	d ₂ Ø, -0.025	z	C835
	mm	Inch	mm	mm	mm	mm	Inch	mm		
60°	4.0	1/2	12.70	7.15	16.5	63.50	1/2	12.70	6	C8351/2
60°	4.0		13.00	7.15	16.5	63.50		12.00	6	C83513.0
60°	5.5	5/8	15.88	7.55	18.0	66.50	1/2	12.70	6	C8355/8
60°	5.5		16.00	7.55	18.0	66.50		12.00	6	C83516.0
60°	7.0		19.00	8.35	17.5	67.50		12.00	6	C83519.0
60°	7.0	3/4	19.05	8.35	17.5	67.50	1/2	12.70	6	C8353/4
60°	9.5		22.00	8.75	15.0	67.50		12.00	6	C83522.0
60°	9.5	7/8	22.23	8.75	15.0	67.50	1/2	12.70	6	C8357/8
60°	12.0		25.00	8.75	15.0	70.00		12.00	6	C83525.0
60°	12.0	1"	25.40	8.75	15.0	70.00	1/2	12.70	6	C8351
60°	12.5		28.00	11.10	15.5	73.00		16.00	6	C83528.0
60°	12.5	1.1/8	28.58	11.10	15.5	73.00	5/8	15.88	6	C8351.1/8
60°	13.5		32.00	12.70	16.0	74.50		16.00	8	C83532.0
60°	13.5	1.1/4	31.75	12.70	16.0	74.50	5/8	15.88	8	C8351.1/4
60°	14.5	1.3/8	34.93	12.70	16.0	82.50	1"	25.40	8	C8351.3/8
60°	14.5		35.00	12.70	16.0	82.50		25.00	8	C83535.0
60°	16.0		38.00	17.45	16.0	84.00		25.00	8	C83538.0
60°	16.0	1.1/2	38.10	17.45	16.0	84.00	1"	25.40	8	C8351.1/2

C830 HSS-E N Z 10-12 $\lambda 0^\circ$ $\gamma 0^\circ$ DIN 1835B js16 DIN 1833C

- 燕尾槽铣刀
- Fresa Rabo de Andorinha
- Fresas de cola de milano
- Dovetail Cutter

C830

C830	1.1	1.2	1.3	1.4	1.5	1.6	2.1	2.2	2.3	3.1	3.2	3.3	3.4	4.1	4.2	4.3	5.1	5.2	5.3	6.1	
	6.2	6.3	6.4	7.1	7.2	7.3	7.4	8.1	10.1												

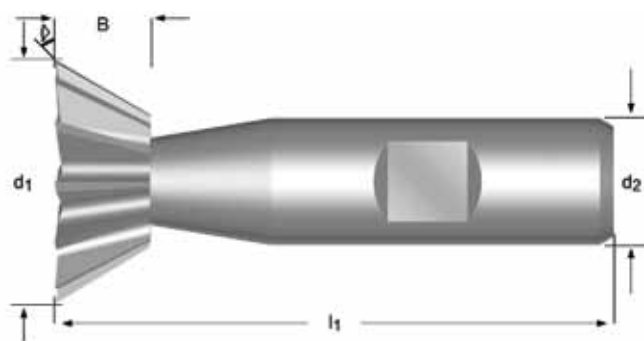

φ	B	d_1	l_1	d_2	\varnothing_{h_6}	z	C830
	mm	mm	mm	mm	mm		
45°	3.5	12.0	54	10	10	10	C83012.0X45
45°	4.0	16.0	60	12	10	10	C83016.0X45
45°	5.0	20.0	63	12	10	10	C83020.0X45
45°	6.3	25.0	67	12	10	10	C83025.0X45
45°	8.0	32.0	71	16	12	12	C83032.0X45
60°	5.0	12.0	54	10	10	10	C83012.0X60
60°	6.3	16.0	60	12	10	10	C83016.0X60
60°	8.0	20.0	63	12	10	10	C83020.0X60
60°	10.0	25.0	67	12	10	10	C83025.0X60
60°	12.5	32.0	71	16	12	12	C83032.0X60

C831



- 反燕尾槽铣刀
- Fresas Rabo de Andorinha Invertidas
- Fresa para cola de milano Inversa
- Inverse Dovetail Cutters

C831

C831	1.1	1.2	1.3	1.4	1.5	1.6	2.1	2.2	2.3	3.1	3.2	3.3	3.4	4.1	4.2	4.3	5.1	5.2	5.3	6.1	
	6.2	6.3	6.4	7.1	7.2	7.3	7.4	8.1	10.1												

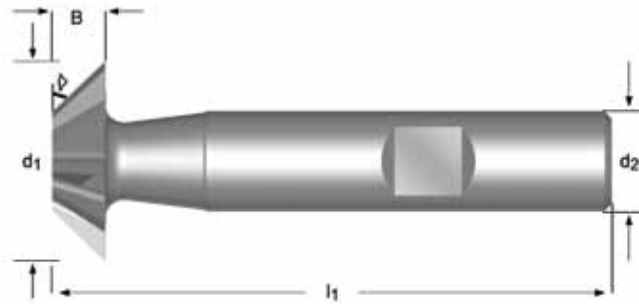

∠	B	d ₁ ∅	l ₁	d ₂ ∅h ₆	z	C831
	mm	mm	mm	mm		
45°	3.5	12.0	54	10	10	C83112.0X45
45°	4.0	16.0	60	12	10	C83116.0X45
45°	5.0	20.0	63	12	10	C83120.0X45
45°	6.3	25.0	67	12	10	C83125.0X45
45°	8.0	32.0	71	16	12	C83132.0X45
60°	5.0	12.0	54	10	10	C83112.0X60
60°	6.3	16.0	60	12	10	C83116.0X60
60°	8.0	20.0	63	12	10	C83120.0X60
60°	10.0	25.0	67	12	10	C83125.0X60
60°	12.5	32.0	71	16	12	C83132.0X60

C710



- 圓角铣刀
- Fresa com Canto Arredondado
- Fresas frontales de perfil cóncavo
- Corner Rounding Cutter

C710

C710	▪	1.1	1.2	1.3	1.4	2.1	2.2	3.1	3.2	3.3	3.4	4.1	4.2	5.1	5.2	6.1	6.2	6.3	7.1	7.2	7.3	
	•	1.5	1.6	2.3	4.3	5.3	6.4	7.4	10.1													

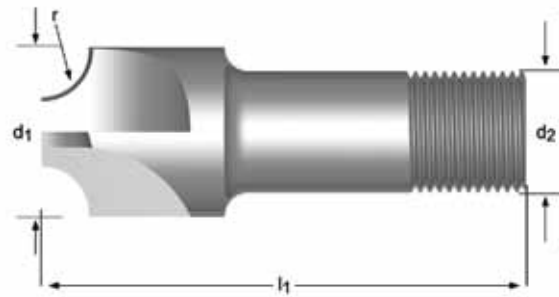

r	d ₁	d ₂	d ₂	l ₁	z	C710
Inch	Inch	Øh ₈ Inch	Ø mm	mm		
1/16	3/8	3/8	9.53	60.5	4	C7101/16
3/32	7/16	3/8	9.53	60.5	4	C7103/32
1/8	1/2	1/2	12.70	60.5	4	C7101/8
5/32	9/16	1/2	12.70	60.5	4	C7105/32
3/16	5/8	5/8	15.88	60.5	4	C7103/16
7/32	3/4	5/8	15.88	63.5	4	C7107/32
1/4	7/8	5/8	15.88	63.5	4	C7101/4
5/16	1"	1"	25.40	73.0	4	C7105/16
3/8	1.1/16	1"	25.40	76.0	4	C7103/8
7/16	1.3/16	1"	25.40	79.5	4	C7107/16
1/2	1.3/8	1"	25.40	82.5	4	C7101/2

C700



- 圆角铣刀
- Fresa com Canto Arredondado
- Fresas frontales de perfil cóncavo
- Corner Rounding Cutter

C700

C700	1.1	1.2	1.3	1.4	1.5	1.6	2.1	2.2	2.3	3.1	3.2	3.3	3.4	4.1	4.2	4.3	5.1	5.2	5.3	6.1	
	6.2	6.3	6.4	7.1	7.2	7.3	7.4	10.1													

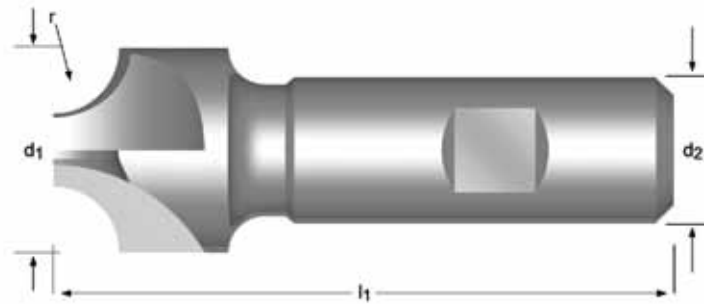

r mm	d ₁ Ø mm	d ₂ Ø _{h₆} mm	l ₁ mm	z	C700
1.00	10	10	60	4	C7001.0
1.50	10	10	60	4	C7001.5
2.00	10	10	60	4	C7002.0
2.50	10	10	60	4	C7002.5
3.00	12	12	60	4	C7003.0
3.50	12	12	60	4	C7003.5
4.00	15	12	60	4	C7004.0
5.00	18	16	70	4	C7005.0
6.00	21	16	70	4	C7006.0
7.00	24	16	70	4	C7007.0
8.00	24	16	70	4	C7008.0
9.00	28	20	85	4	C7009.0
10.00	28	20	85	4	C70010.0
12.00	35	20	100	4	C70012.0
12.50	35	20	100	4	C70012.5
14.00	42	25	100	4	C70014.0
15.00	48	25	105	5	C70015.0
16.00	48	25	105	5	C70016.0
18.00	52	32	115	5	C70018.0
20.00	60	32	115	6	C70020.0



- D200**
- 三面刃铣刀
 - Fresa de Faceamento Lateral
- D763**
- Fresa para ranurar
 - Side and Face Milling Cutter

D200; D763	1.1	1.2	1.3	1.4	1.5	1.6	2.1	2.2	2.3	3.1	3.2	3.3	3.4	4.1	4.2	4.3	5.1	5.2
	5.3	6.1	6.2	6.3	6.4	7.1	7.2	7.3	7.4	8.1								

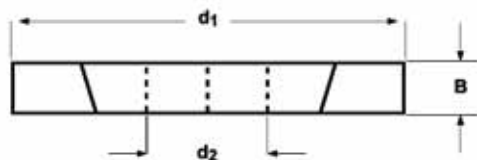

d_1 Ø mm	B mm	d_2 Ø mm	z	D200	D763
50.00	4.0	16	16	D20050.0X4.0	
50.00	5.0	16	16	D20050.0X5.0	
50.00	6.0	16	16	D20050.0X6.0	
50.00	8.0	16	16	D20050.0X8.0	
50.00	10.0	16	16	D20050.0X10.0	
63.00	1.6	22	32		D76363.0X1.6
63.00	2.0	22	32		D76363.0X2.0
63.00	2.5	22	32		D76363.0X2.5
63.00	3.0	22	28		D76363.0X3.0
63.00	3.5	22	28		D76363.0X3.5
63.00	4.0	22	18	D20063.0X4.0	
63.00	5.0	22	18	D20063.0X5.0	
63.00	6.0	22	18	D20063.0X6.0	
63.00	8.0	22	18	D20063.0X8.0	
63.00	10.0	22	18	D20063.0X10.0	
63.00	12.0	22	18	D20063.0X12.0	
63.00	14.0	22	18	D20063.0X14.0	
63.00	16.0	22	16	D20063.0X16.0	
80.00	2.0	27	36		D76380.0X2.0
80.00	2.5	27	36		D76380.0X2.5
80.00	3.0	27	32		D76380.0X3.0
80.00	3.5	27	32		D76380.0X3.5
80.00	4.0	27	20	D20080.0X4.0	
80.00	5.0	27	20	D20080.0X5.0	
80.00	6.0	27	20	D20080.0X6.0	
80.00	8.0	27	20	D20080.0X8.0	
80.00	10.0	27	18	D20080.0X10.0	
80.00	12.0	27	18	D20080.0X12.0	
80.00	14.0	27	18	D20080.0X14.0	
80.00	16.0	27	18	D20080.0X16.0	
80.00	20.0	27	18	D20080.0X20.0	
100.00	2.0	32	44		D763100.0X2.0
100.00	2.5	32	44		D763100.0X2.5
100.00	3.0	32	40		D763100.0X3.0

d_1 Ø mm	B mm	d_2 Ø mm	z	D200	D763
100.00	3.5	32	40		D763100.0X3.5
100.00	4.0	32	24	D200100.0X4.0	
100.00	5.0	32	24	D200100.0X5.0	
100.00	6.0	32	24	D200100.0X6.0	
100.00	8.0	32	22	D200100.0X8.0	
100.00	10.0	32	22	D200100.0X10.0	
100.00	12.0	32	20	D200100.0X12.0	
100.00	14.0	32	20	D200100.0X14.0	
100.00	16.0	32	20	D200100.0X16.0	
100.00	18.0	32	20	D200100.0X18.0	
100.00	20.0	32	20	D200100.0X20.0	
100.00	25.0	32	20	D200100.0X25.0	
125.00	2.0	32	44		D763125.0X2.0
125.00	2.5	32	44		D763125.0X2.5
125.00	3.0	32	44		D763125.0X3.0
125.00	3.5	32	40		D763125.0X3.5
125.00	4.0	32	40		D763125.0X4.0
125.00	6.0	32	26	D200125.0X6.0	
125.00	8.0	32	26	D200125.0X8.0	
125.00	10.0	32	24	D200125.0X10.0	
125.00	12.0	32	22	D200125.0X12.0	
125.00	14.0	32	22	D200125.0X14.0	
125.00	16.0	32	22	D200125.0X16.0	
125.00	20.0	32	22	D200125.0X20.0	
125.00	25.0	32	22	D200125.0X25.0	
160.00	8.0	40	28	D200160.0X8.0	
160.00	10.0	40	26	D200160.0X10.0	
160.00	12.0	40	26	D200160.0X12.0	
160.00	14.0	40	24	D200160.0X14.0	
160.00	16.0	40	24	D200160.0X16.0	
160.00	18.0	40	24	D200160.0X18.0	
160.00	20.0	40	24	D200160.0X20.0	
200.00	12.0	40	30	D200200.0X12.0	
200.00	16.0	40	30	D200200.0X16.0	
200.00	20.0	40	30	D200200.0X20.0	

D745

HSS



Z
28-100

$\gamma 15^\circ$

DIN
1838

- 粗齿的锯片铣刀
- Serra Circular para Abertura de Rasgos Largos
- Sierras de ranurar o tronzar Grueso
- Metal slitting saw Coarse

D745

D745	▪	1.1	1.2	1.3	1.4	3.1	3.2	3.3	6.1	6.2	6.3	7.1	7.2	7.3	8.1
	•	2.1	2.2												

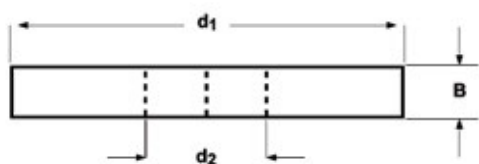

d_1 Ø mm	B mm	d_2 Ø mm	z	D745
50.00	0.5	13	48	D74550.0X.5
50.00	0.6	13	48	D74550.0X.6
50.00	0.8	13	40	D74550.0X.8
50.00	1.0	13	40	D74550.0X1.0
50.00	1.2	13	40	D74550.0X1.2
50.00	1.5	13	32	D74550.0X1.5
50.00	1.6	13	32	D74550.0X1.6
50.00	2.0	13	32	D74550.0X2.0
50.00	2.5	13	32	D74550.0X2.5
50.00	3.0	13	24	D74550.0X3.0
63.00	0.5	16	64	D74563.0X.5
63.00	0.6	16	48	D74563.0X.6
63.00	0.8	16	48	D74563.0X.8
63.00	1.0	16	48	D74563.0X1.0
63.00	1.2	16	40	D74563.0X1.2
63.00	1.5	16	40	D74563.0X1.5
63.00	1.6	16	40	D74563.0X1.6
63.00	2.0	16	40	D74563.0X2.0
63.00	2.5	16	32	D74563.0X2.5
63.00	3.0	16	32	D74563.0X3.0
80.00	0.5	22	64	D74580.0X.5
80.00	0.6	22	64	D74580.0X.6
80.00	0.8	22	64	D74580.0X.8
80.00	1.0	22	48	D74580.0X1.0
80.00	1.2	22	48	D74580.0X1.2
80.00	1.5	22	48	D74580.0X1.5
80.00	1.6	22	48	D74580.0X1.6
80.00	2.0	22	40	D74580.0X2.0
80.00	2.5	22	40	D74580.0X2.5
80.00	3.0	22	40	D74580.0X3.0
80.00	4.0	22	32	D74580.0X4.0
80.00	5.0	22	32	D74580.0X5.0
80.00	6.0	22	32	D74580.0X6.0
100.00	0.5	22	80	D745100.0X.5
100.00	0.6	22	80	D745100.0X.6
100.00	0.8	22	64	D745100.0X.8
100.00	1.0	22	64	D745100.0X1.0
100.00	1.2	22	64	D745100.0X1.2

d_1 Ø mm	B mm	d_2 Ø mm	z	D745
100.00	1.5	22	48	D745100.0X1.5
100.00	1.6	22	48	D745100.0X1.6
100.00	2.0	22	48	D745100.0X2.0
100.00	2.5	22	48	D745100.0X2.5
100.00	3.0	22	40	D745100.0X3.0
100.00	4.0	22	40	D745100.0X4.0
100.00	5.0	22	40	D745100.0X5.0
100.00	6.0	22	32	D745100.0X6.0
125.00	1.0	22	80	D745125.0X1.0
125.00	1.2	22	64	D745125.0X1.2
125.00	1.5	22	64	D745125.0X1.5
125.00	1.6	22	64	D745125.0X1.6
125.00	2.0	22	64	D745125.0X2.0
125.00	2.5	22	48	D745125.0X2.5
125.00	3.0	22	48	D745125.0X3.0
125.00	4.0	22	48	D745125.0X4.0
125.00	5.0	22	40	D745125.0X5.0
125.00	6.0	22	40	D745125.0X6.0
160.00	1.0	32	80	D745160.0X1.0
160.00	1.2	32	80	D745160.0X1.2
160.00	1.5	32	80	D745160.0X1.5
160.00	1.6	32	80	D745160.0X1.6
160.00	2.0	32	64	D745160.0X2.0
160.00	2.5	32	64	D745160.0X2.5
160.00	3.0	32	64	D745160.0X3.0
160.00	4.0	32	48	D745160.0X4.0
160.00	5.0	32	48	D745160.0X5.0
160.00	6.0	32	48	D745160.0X6.0
200.00	1.0	32	100	D745200.0X1.0
200.00	1.2	32	100	D745200.0X1.2
200.00	1.5	32	80	D745200.0X1.5
200.00	1.6	32	80	D745200.0X1.6
200.00	2.0	32	80	D745200.0X2.0
200.00	2.5	32	80	D745200.0X2.5
200.00	3.0	32	64	D745200.0X3.0
200.00	4.0	32	64	D745200.0X4.0
200.00	5.0	32	64	D745200.0X5.0
200.00	6.0	32	48	D745200.0X6.0
250.00	2.0	32	100	D745250.0X2.0
250.00	2.5	32	80	D745250.0X2.5
250.00	3.0	32	80	D745250.0X3.0
250.00	4.0	32	80	D745250.0X4.0
250.00	5.0	32	64	D745250.0X5.0
250.00	6.0	32	64	D745250.0X6.0
315.00	2.5	40	100	D745315.0X2.5
315.00	3.0	40	100	D745315.0X3.0

D747 HSS          

- 细齿的锯片铣刀
- Serra Circular para Abertura de Rasgos Finos
- Sierras de ranurar o tronzar fino
- Metal slitting saw Fine

D747

D747 ■ 1.1 1.2 1.3 1.4 3.1 3.2 3.3 6.1 6.2 6.3 7.1 7.2 7.3 8.1
 • 2.1 2.2

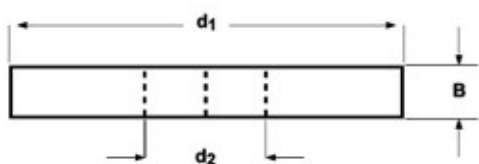

D747

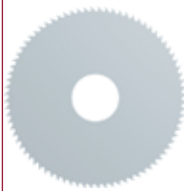

32.00 - 315.00

d ₁ Ø mm	B mm	d ₂ Ø mm	z	D747
32.00	0.3	8	80	D74732.0X.3
32.00	0.4	8	80	D74732.0X.4
32.00	0.5	8	80	D74732.0X.5
32.00	0.6	8	64	D74732.0X.6
32.00	0.8	8	64	D74732.0X.8
32.00	1.0	8	64	D74732.0X1.0
32.00	1.2	8	48	D74732.0X1.2
32.00	1.5	8	48	D74732.0X1.5
32.00	1.6	8	48	D74732.0X1.6
32.00	2.0	8	48	D74732.0X2.0
32.00	2.5	8	40	D74732.0X2.5
32.00	3.0	8	40	D74732.0X3.0
40.00	0.3	10	100	D74740.0X.3
40.00	0.4	10	100	D74740.0X.4
40.00	0.5	10	80	D74740.0X.5
40.00	0.6	10	80	D74740.0X.6
40.00	0.8	10	80	D74740.0X.8
40.00	1.0	10	64	D74740.0X1.0
40.00	1.2	10	64	D74740.0X1.2
40.00	1.5	10	64	D74740.0X1.5
40.00	1.6	10	64	D74740.0X1.6
40.00	2.0	10	48	D74740.0X2.0
40.00	2.5	10	48	D74740.0X2.5
40.00	3.0	10	48	D74740.0X3.0
50.00	0.3	13	128	D74750.0X.3
50.00	0.4	13	100	D74750.0X.4
50.00	0.5	13	100	D74750.0X.5
50.00	0.6	13	100	D74750.0X.6
50.00	0.8	13	80	D74750.0X.8
50.00	1.0	13	80	D74750.0X1.0
50.00	1.2	13	80	D74750.0X1.2
50.00	1.5	13	64	D74750.0X1.5
50.00	1.6	13	64	D74750.0X1.6
50.00	2.0	13	64	D74750.0X2.0
50.00	2.5	13	64	D74750.0X2.5
50.00	3.0	13	48	D74750.0X3.0
50.00	4.0	13	48	D74750.0X4.0
50.00	5.0	13	48	D74750.0X5.0

d_1 Ø mm	B mm	d_2 Ø mm	z	D747
50.00	6.0	13	40	D74750.0X6.0
63.00	0.3	16	128	D74763.0X.3
63.00	0.4	16	128	D74763.0X.4
63.00	0.5	16	128	D74763.0X.5
63.00	0.6	16	100	D74763.0X.6
63.00	0.8	16	100	D74763.0X.8
63.00	1.0	16	100	D74763.0X1.0
63.00	1.2	16	80	D74763.0X1.2
63.00	1.5	16	80	D74763.0X1.5
63.00	1.6	16	80	D74763.0X1.6
63.00	2.0	16	80	D74763.0X2.0
63.00	2.5	16	64	D74763.0X2.5
63.00	3.0	16	64	D74763.0X3.0
63.00	4.0	16	64	D74763.0X4.0
63.00	5.0	16	48	D74763.0X5.0
63.00	6.0	16	48	D74763.0X6.0
80.00	0.4	22	160	D74780.0X.4
80.00	0.5	22	128	D74780.0X.5
80.00	0.6	22	128	D74780.0X.6
80.00	0.8	22	128	D74780.0X.8
80.00	1.0	22	100	D74780.0X1.0
80.00	1.2	22	100	D74780.0X1.2
80.00	1.5	22	100	D74780.0X1.5
80.00	1.6	22	100	D74780.0X1.6
80.00	2.0	22	80	D74780.0X2.0
80.00	2.5	22	80	D74780.0X2.5
80.00	3.0	22	80	D74780.0X3.0
80.00	4.0	22	64	D74780.0X4.0
80.00	5.0	22	64	D74780.0X5.0
80.00	6.0	22	64	D74780.0X6.0
100.00	0.5	22	160	D747100.0X.5
100.00	0.6	22	160	D747100.0X.6
100.00	0.8	22	128	D747100.0X.8
100.00	1.0	22	128	D747100.0X1.0
100.00	1.2	22	128	D747100.0X1.2
100.00	1.5	22	100	D747100.0X1.5
100.00	1.6	22	100	D747100.0X1.6
100.00	2.0	22	100	D747100.0X2.0
100.00	2.5	22	100	D747100.0X2.5
100.00	3.0	22	80	D747100.0X3.0
100.00	4.0	22	80	D747100.0X4.0
100.00	5.0	22	80	D747100.0X5.0
100.00	6.0	22	64	D747100.0X6.0
125.00	1.0	22	160	D747125.0X1.0
125.00	1.2	22	128	D747125.0X1.2
125.00	1.5	22	128	D747125.0X1.5
125.00	1.6	22	128	D747125.0X1.6
125.00	2.0	22	128	D747125.0X2.0
125.00	2.5	22	100	D747125.0X2.5
125.00	3.0	22	100	D747125.0X3.0
125.00	4.0	22	100	D747125.0X4.0
125.00	5.0	22	80	D747125.0X5.0
125.00	6.0	22	80	D747125.0X6.0
160.00	1.0	32	160	D747160.0X1.0
160.00	1.2	32	160	D747160.0X1.2
160.00	1.5	32	160	D747160.0X1.5
160.00	1.6	32	160	D747160.0X1.6
160.00	2.0	32	128	D747160.0X2.0
160.00	2.5	32	128	D747160.0X2.5
160.00	3.0	32	128	D747160.0X3.0
160.00	4.0	32	100	D747160.0X4.0
160.00	5.0	32	100	D747160.0X5.0
160.00	6.0	32	100	D747160.0X6.0
200.00	1.0	32	200	D747200.0X1.0
200.00	1.2	32	200	D747200.0X1.2
200.00	1.5	32	160	D747200.0X1.5
200.00	1.6	32	160	D747200.0X1.6
200.00	2.0	32	160	D747200.0X2.0

d_1 Ø mm	B mm	d_2 Ø mm	z	D747
200.00	2.5	32	160	D747200.0X2.5
200.00	3.0	32	128	D747200.0X3.0
200.00	4.0	32	128	D747200.0X4.0
200.00	5.0	32	128	D747200.0X5.0
200.00	6.0	32	100	D747200.0X6.0
250.00	2.0	32	200	D747250.0X2.0
250.00	2.5	32	160	D747250.0X2.5
250.00	3.0	32	160	D747250.0X3.0
250.00	4.0	32	160	D747250.0X4.0
250.00	5.0	32	128	D747250.0X5.0
250.00	6.0	32	128	D747250.0X6.0
315.00	2.5	40	200	D747315.0X2.5
315.00	3.0	40	200	D747315.0X3.0
315.00	4.0	40	160	D747315.0X4.0
315.00	5.0	40	160	D747315.0X5.0
315.00	6.0	40	160	D747315.0X6.0



- D752**
- 粗齿的锯片铣刀
 - Serra Circular para Abertura de Rasgos Largos
- D753**
- Sierras de ranurar o tronzar Grueso
 - Metal slitting saw Coarse

D752; D753	■	1.1	1.2	1.3	1.4	3.1	3.2	3.3	6.1	6.2	6.3	7.1	7.2	7.3	8.1	
	•	2.1	2.2													

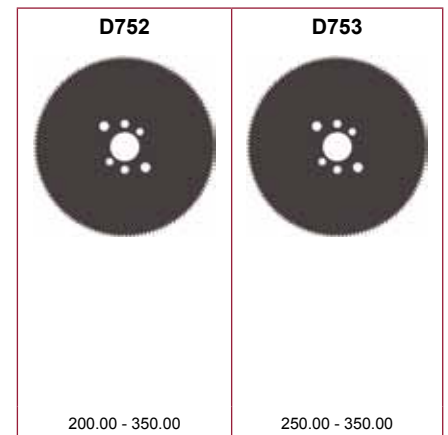
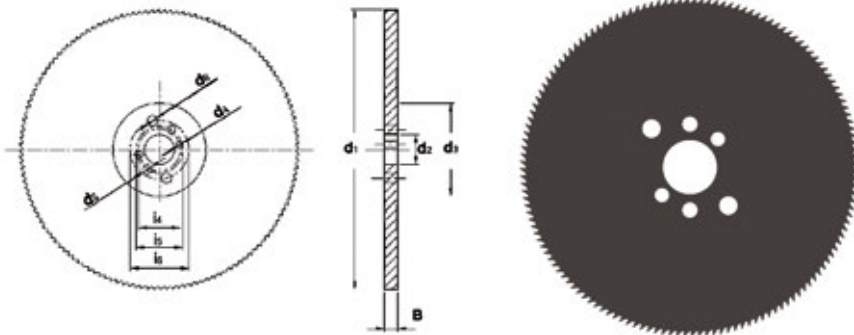

d_1 Ø mm	B mm	d_2 Ø mm	z	P mm	d_3 Ø mm	d_4 Ø mm	i_4 mm	d_5 Ø mm	i_5 mm	d_6 Ø mm	i_6 mm	D752	D753
200	1.8	32	80	8	100	8	45	9	50	11	63	D752200.0X1.8X80	
200	1.8	32	100	6	100	8	45	9	50	11	63	D752200.0X1.8X100	
225	2.0	32	90	8	100	8	45	9	50	11	63	D752225.0X2.0X90	
225	2.0	32	120	6	100	8	45	9	50	11	63	D752225.0X2.0X120	
250	2.0	32	100	8	100	8	45	9	50	11	63		D753250.0X2.0
250	2.0	32	128	6	100	8	45	9	50	11	63	D752250.0X2.0X128	
275	2.5	32	110	8	100	8	45	9	50	11	63	D752275.0X2.5X110	
300	2.5	32	120	8	100	8	45	9	50	11	63		D753300.0X2.5
300	2.5	32	160	6	100	8	45	9	50	11	63	D752300.0X2.5X160	
315	2.5	32	120	8	100	8	45	9	50	11	63		D753315.0X2.5
315	2.5	32	160	6	100	8	45	9	50	11	63	D752315.0X2.5X160	
350	2.5	32	140	8	120	8	45	9	50	11	63		D753350.0X2.5
350	2.5	32	180	6	120	8	45	9	50	11	63	D752350.0X2.5X180	

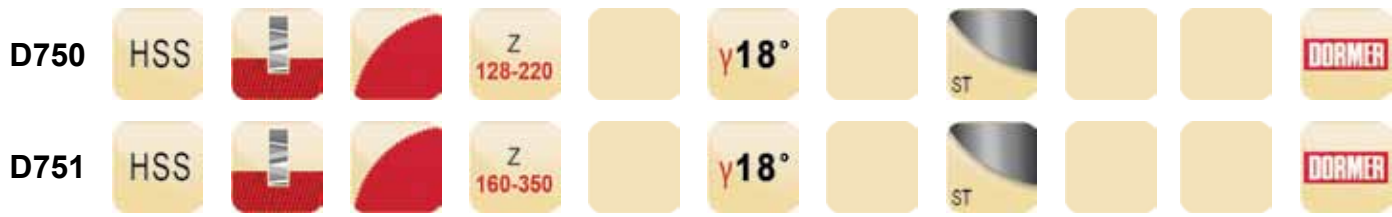

- D750**
- 粗齿的锯片铣刀
 - Serra Circular para Abertura de Rasgos Largos
- D751**
- Sierras de ranurar o tronzar Grueso
 - Metal slitting saw Coarse

D750; D751	■	1.1	1.2	1.3	1.4	3.1	3.2	3.3	6.1	6.2	6.3	7.1	7.2	7.3	8.1	
	•	2.1	2.2													

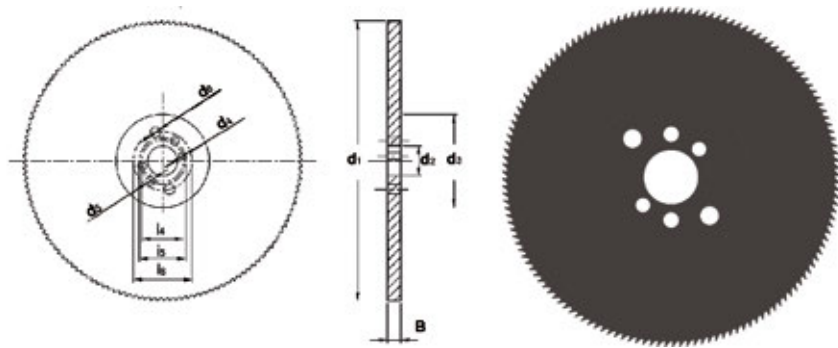

d ₁ Ø mm	B mm	d ₂ Ø mm	z	P mm	d ₃ Ø mm	d ₄ Ø mm	i ₄ mm	d ₅ Ø mm	i ₅ mm	d ₆ Ø mm	i ₆ mm	D750	D751
200	1.8	32	130	5	100	8	45	9	50	11	63	D750200.0X1.8	
200	1.8	32	160	4	100	8	45	9	50	11	63		D751200.0X1.8X160
200	1.8	32	200	3	100	8	45	9	50	11	63		D751200.0X1.8X200
225	2.0	32	140	5	100	8	45	9	50	11	63	D750225.0X2.0	
225	2.0	32	180	4	100	8	45	9	50	11	63		D751225.0X2.0X180
225	2.0	32	220	3	100	8	45	9	50	11	63		D751225.0X2.0X220
250	2.0	32	160	5	100	8	45	9	50	11	63	D750250.0X2.0	
250	2.0	32	200	4	100	8	45	9	50	11	63		D751250.0X2.0X200
250	2.0	32	250	3	100	8	45	9	50	11	63		D751250.0X2.0X250
275	2.5	32	180	5	100	8	45	9	50	11	63	D750275.0X2.5	
275	2.5	32	220	4	100	8	45	9	50	11	63		D751275.0X2.5X220
275	2.5	32	280	3	100	8	45	9	50	11	63		D751275.0X2.5X280
300	2.5	32	180	5	100	8	45	9	50	11	63	D750300.0X2.5	
300	2.5	32	220	4	100	8	45	9	50	11	63		D751300.0X2.5X220
300	2.5	32	300	3	100	8	45	9	50	11	63		D751300.0X2.5X300
315	2.5	32	200	5	100	8	45	9	50	11	63	D750315.0X2.5	
315	2.5	32	240	4	100	8	45	9	50	11	63		D751315.0X2.5X240
315	2.5	32	320	3	100	8	45	9	50	11	63		D751315.0X2.5X320
350	2.5	32	220	5	120	8	45	9	59	11	63	D750350.0X2.5	
350	2.5	32	280	4	120	8	45	9	50	11	63		D751350.0X2.5X280
350	2.5	32	350	3	120	8	45	9	50	11	63		D751350.0X2.5X350

D400	HSS-E		N	Z 8-12		$\lambda 30^\circ$ $\gamma 12^\circ$			js16		DIN 1880
D420	HSS-E		N	Z 8-12		$\lambda 30^\circ$ $\gamma 12^\circ$		TICN	js16		DIN 1880

- D400**
- 套式立铣刀
 - Fresa Caracol
- D420**
- Fresas frontales cilíndricas
 - Shell End Mill

D400	▪	1.1	1.2	1.3	1.4	2.1	2.3	3.1	3.2	3.3	3.4	4.1	5.1	6.1	6.2	6.3	7.2	7.3			
	•	1.5	1.6	2.2	4.2	4.3	5.2	5.3	6.4	7.1	7.4	8.1	8.2	8.3	10.1						
D420	▪	1.1	1.2	1.3	1.4	1.5	1.6	2.1	2.2	2.3	3.1	3.2	3.3	3.4	4.1	4.2	4.3	5.1	5.2	5.3	6.1
		6.2	6.3	6.4	7.2	7.3	7.4	8.1	10.1												
	•	7.1	8.2	8.3																	

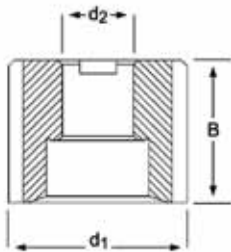

d_1 Ø mm	B mm	d_2 Ø mm	z	D400	D420
40.00	32	16	8	D40040.0	D42040.0
50.00	36	22	8	D40050.0	D42050.0
63.00	40	27	8	D40063.0	D42063.0
80.00	45	27	10	D40080.0	D42080.0
100.00	50	32	12	D400100.0	D420100.0

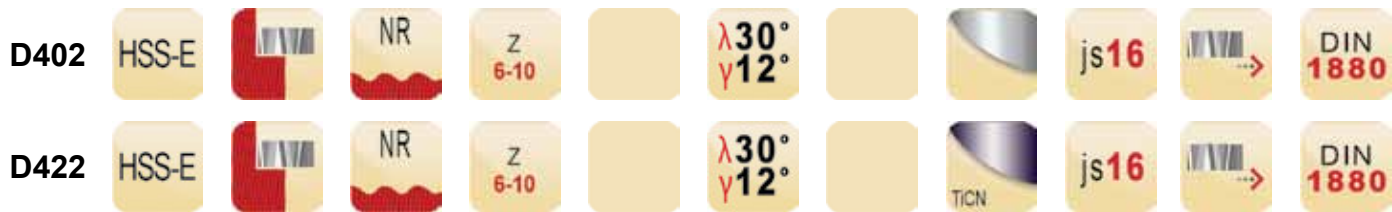

- D402**
- 粗加工立铣刀
 - Fresa Caracol para Desbaste
- D422**
- Fresas de Acabamento Tip tacho
 - Roughing Shell End Mill

D402	▪	1.1	1.2	1.3	1.4	2.1	2.3	3.1	3.2	3.3	3.4	4.1	5.1	6.1	6.2	6.3	7.2	7.3			
	•	1.5	1.6	2.2	4.2	4.3	5.2	5.3	6.4	7.1	7.4	8.1	8.2	8.3	10.1						
D422	▪	1.1	1.2	1.3	1.4	1.5	1.6	2.1	2.2	2.3	3.1	3.2	3.3	3.4	4.1	4.2	4.3	5.1	5.2	5.3	6.1
		6.2	6.3	6.4	7.2	7.3	7.4	8.1	10.1												
	•	7.1	8.2	8.3																	

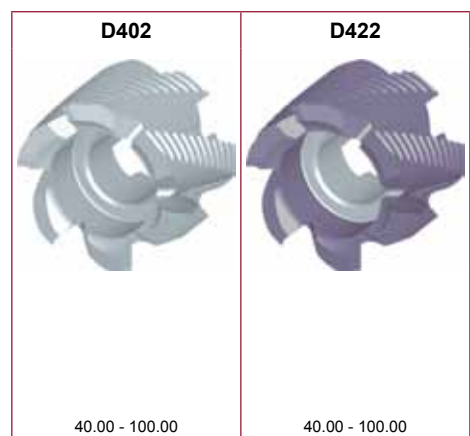
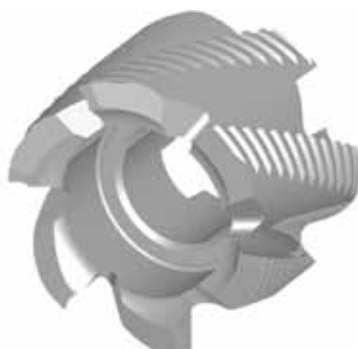
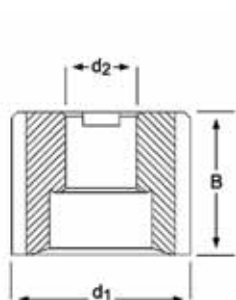

d_1 Ø mm	B mm	d_2 Ø mm	z	D402	D422
40.00	32	16	6	D40240.0	D42240.0
50.00	36	22	6	D40250.0	D42250.0
63.00	40	27	8	D40263.0	D42263.0
80.00	45	27	8	D40280.0	D42280.0
100.00	50	32	10	D402100.0	D422100.0

K100	471	K301	468	K331	470
K101	471	K302	468	K332	470
K102	471	K303	468	K333	470
K103	472	K304	468	K334	470
K104	472	K305	468	K520	474
K200	473	K310	469	K521	475
K201	473	K311	469	K522	476
K202	473	K312	469	M150	477
K203	473	K313	469	M151	478
K204	473	K314	469	M152	479
K300	468	K330	470	M200	480

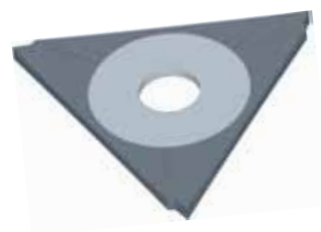

463 - 480







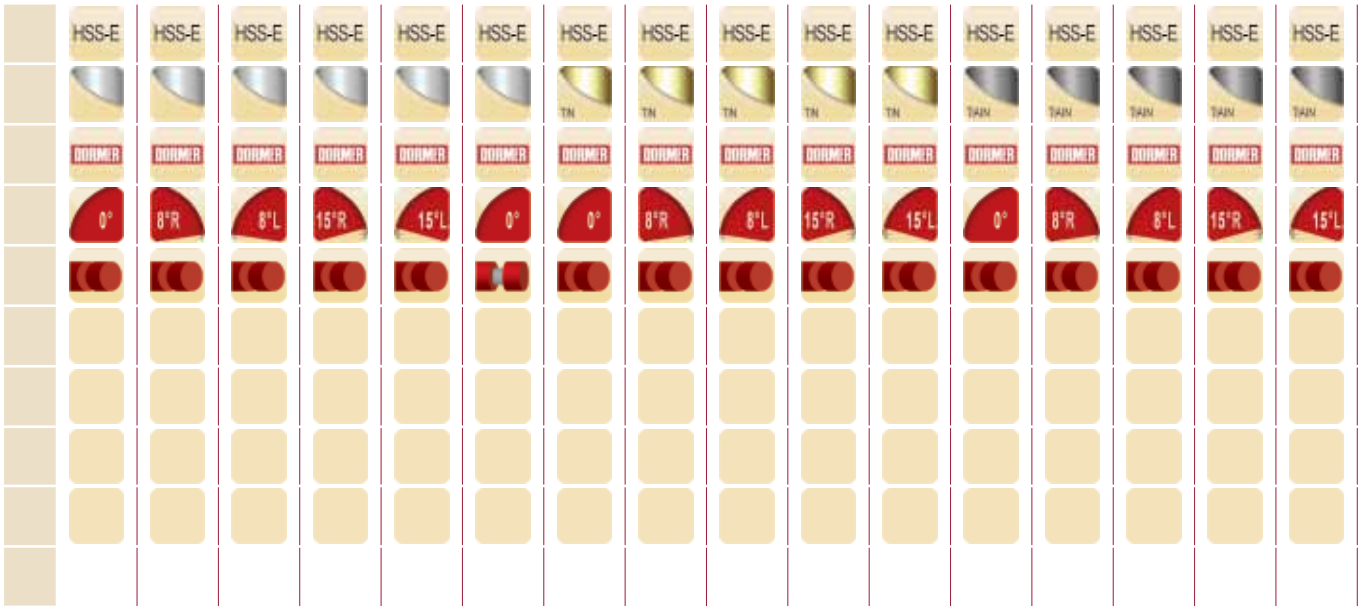















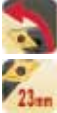
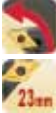

材料	Material	Material	Material
涂层	Tratamento	Tratamiento superficial	Coating
标准	Norma	Estándar	Standard
刀刃角	Ângulo de corte	° de corte inclinado	Edge angle
应用	Aplicação	Aplicaciones	Application
切削方向	Direção de corte	Dirección de corte	Direction of cut
刀片尺寸	Tamanho do inserto	Tamaño	Insert Size
形状	Forma	Formas	Form
公差	Tolerância	Tolerancia	Tolerance
■ 性能卓越	Excelente para a Aplicação	Excelente para Aplicación	Excellent for Application
■ 性能良好	Bom para a Aplicação	Bueno para Aplicación	Good for Application
实例 10 = 外缘处的切削速度, 米/分, +/- 10%	Exemplo 10 = Velocidade periférica em metros/minuto +/- 10%	Ejemplo 10 = Velocidad Periférica en metros/minuto +/- 10%	Example 10 = Peripheral speed in metres/minute +/- 10%
产品型号	Código	Código de producto	Product Codes
尺寸范围	Gama de medidas	Rango de Diámetros	Size Range

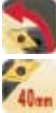





AMG	中文	Português	Español	English
1.1	铁磁性低碳钢	Aço macio magnético	Acero blando	Magnetic soft steel
1.2	结构钢, 表面渗碳钢	Aço estrutural, Aço cementado	Acero de construcción/cementación	Structural steel, case carburizing steel
1.3	普通碳钢	Aço-carbono	Acero al carbono	Plain Carbon steel
1.4	合金钢	Aço de liga	Acero aleado	Alloy steel
1.5	合金钢, 淬火回火钢	Aço de liga, Aço temperado	Acero aleado/temple y revenido	Alloy steel, Hardened and tempered steel
1.6	合金钢, 淬火回火钢	Aço de liga, Aço temperado	Acero aleado/temple y revenido	Alloy steel, Hardened and tempered steel
1.7	热处理合金钢	Aço de liga temperado	Acero aleado cementado	Alloy steel, Heat treated
1.8	淬火合金钢, 耐磨钢	Aço de liga temperado	Acero aleado cementado	Alloy steel, Hardened & Wear resistant steel
2.1	易切削不锈钢	Aço inoxidável de maquinação fácil	Acero inoxidable fácil mecanizado	Free machining, Stainless Steel
2.2	奥氏体不锈钢	Austenítico	Austenítico	Austenitic
2.3	铁素体 + 奥氏体, 马氏体不锈钢	Ferrítico + Austenítico + Martensítico	Ferrítico, Ferr. + Aust., Marten	Ferritic + Austenitic, Ferritic, Martensitic
2.4	沉淀硬化不锈钢	Aço inoxidável de fácil usinagem	Acero Inoxidable Templado	Precipitation Hardened
3.1	灰铸铁	Grafite laminar	Con grafito laminar	Lamellar graphite
3.2	灰铸铁	Grafite laminar	Con grafito laminar	Lamellar graphite
3.3	球墨铸铁, 可锻铸铁	Grafite nodular/ Ferro fundido maleável	Con graf. laminar, fundic. maleable	Nodular graphite, Malleable Cast Iron
3.4	球墨铸铁, 可锻铸铁	Grafite nodular/ Ferro fundido maleável	Con graf. laminar, fundic. maleable	Nodular graphite, Malleable Cast Iron
4.1	纯钛	Titânio, sem liga	Titanio no aleado	Titanium, unalloyed
4.2	钛合金	Titânio, com liga	Titanio aleado	Titanium, alloyed
4.3	钛合金	Titânio, com liga	Titanio aleado	Titanium, alloyed
5.1	纯镍	Níquel, sem liga	Níquel no aleado	Nickel, unalloyed
5.2	镍合金	Níquel, com liga	Níquel aleado	Nickel, alloyed
5.3	镍合金	Níquel, com liga	Níquel aleado	Nickel, alloyed
6.1	紫铜	Cobre	Cobre	Copper
6.2	β黄铜, 青铜	Latão beta, bronze	β-Latón, bronce	β-Brass, Bronze
6.3	α黄铜	Latão alfa	α-Latón	α-Brass
6.4	高强度青铜	Bronze de alta resistência	Metal AMPCO	High Strength Bronze
7.1	纯铝, 纯镁	Al, Mg, sem liga	Al, Mg, no aleado	Al, Mg, unalloyed
7.2	铝合金, 硅含量 < 0.5%	Al com liga, Si<0.5%	Al aleado con Si < 0.5%	Al alloyed, Si < 0.5%
7.3	铝合金, 硅含量 > 0.5% < 10%	Al com liga, Si>0.5%<10%	Al aleado con Si > 0.5% < 10%	Al alloyed, Si > 0.5% < 10%
7.4	铝合金, 硅含量 > 10% 晶须增强铝合金, 镁合金	Al com liga, Si>10% reforçadas com monocristais filiformes, ligas de Al/Mg	Al aleado, Si>10% Reforzado por filamentos, Al-aleados, Mg-aleados	Al alloyed, Si > 10% Whisker reinforced Al-alloys Mg-alloys
8.1	热塑性塑料	Termoplásticos	Termoplásticos	Thermoplastics
8.2	热固性塑料	Plásticos termoduros	Plásticos endurecidos por calor	Thermosetting plastics
8.3	增强塑料	Materiais plásticos reforçados	Materiales plásticos reforzados	Reinforced plastic materials
9.1	金属陶瓷	Cerametal (metalocerâmica)	Cermetales (metales-cerámicas)	Cermets (metals-ceramics)
10.1	标准石墨	Grafite standard	Grafito standard	Graphite



K300	K301	K302	K303	K304	K305	K310	K311	K312	K313	K314	K330	K331	K332	K333	K334
1.50 - 2.50	1.50 - 2.50	1.50 - 2.50	1.50 - 2.50	1.50 - 2.50	1.10 - 2.15	23.00 - 40.00	23.00 - 40.00	23.00 - 40.00	23.00 - 40.00	23.00 - 40.00	23.00 - 40.00	23.00 - 40.00	23.00 - 40.00	23.00 - 40.00	23.00 - 40.00

AMG	468	468	468	468	468	468	469	469	469	469	469	470	470	470	470	470	ISO
1.1	50A	50A	50A	50A	50A	50A	120A	120A	120A	120A	120A	120A	120A	120A	120A	120A	P 1
1.2	40B	40B	40B	40B	40B	40B	100B	100B	100B	100B	100B	100B	100B	100B	100B	100B	P 1
1.3	30C	30C	30C	30C	30C	30C	60C	60C	60C	60C	60C	60C	60C	60C	60C	60C	P 2
1.4	20D	20D	20D	20D	20D	20D	50D	50D	50D	50D	50D	50D	50D	50D	50D	50D	P 3
1.5							20E	20E	20E	20E	20E	20E	20E	20E	20E	20E	P 4
1.6																	H 1
1.7																	H 3
1.8																	H 4
2.1	15C	15C	15C	15C	15C	15C	20C	20C	20C	20C	20C	20C	20C	20C	20C	20C	M 1
2.2							20C	20C	20C	20C	20C	20C	20C	20C	20C	20C	M 3
2.3							10B	10B	10B	10B	10B	10B	10B	10B	10B	10B	M 2
2.4																	S 2
3.1																	K 1
3.2																	K 2
3.3																	K 3
3.4																	K 4
4.1		A	0.20	0.25													S 1
4.2		B	0.15	0.20													S 2
4.3		C	0.10	0.15													S 3
5.1		D	0.05	0.10													S 1
5.2		E	0.03	0.05													S 2
5.3																	S 3
6.1	100B	100B	100B	100B	100B	100B	250B	250B	250B	250B	250B	250B	250B	250B	250B	250B	N 3
6.2	65C	65C	65C	65C	65C	65C	160C	160C	160C	160C	160C	160C	160C	160C	160C	160C	N 4
6.3	100B	100B	100B	100B	100B	100B	250B	250B	250B	250B	250B	250B	250B	250B	250B	250B	N 3
6.4																	N 4
7.1	150A	150A	150A	150A	150A	150A	370A	370A	370A	370A	370A	370A	370A	370A	370A	370A	N 1
7.2	150B	150B	150B	150B	150B	150B	370B	370B	370B	370B	370B	370B	370B	370B	370B	370B	N 1
7.3							110C	110C	110C	110C	110C	110C	110C	110C	110C	110C	N 1
7.4							45D	45D	45D	45D	45D	45D	45D	45D	45D	45D	N 2
8.1																	O
8.2																	O
8.3																	O
9.1																	H
10.1																	O

											 	 	 	
														
	K100	K101	K102	K103	K104	K200	K201	K202	K203	K204	K520	K521	K522	
	10.00 - 20.00	12.00 - 20.00	10.00 - 14.00	16.00 - 32.00	16.00 - 32.00	1.50	1.50	1.50	2.50	2.50	4.00 - 1"	3.00 - 1/2	10.00 - 5/8	
AMG	471	471	471	472	472	473	473	473	473	473	474	475	476	ISO
1.1											■80A	■80A	■80A	P 1
1.2											■80A	■80A	■80A	P 1
1.3											■65A	■65A	■65A	P 2
1.4											■55A	■55A	■55A	P 3
1.5											●35A	●35A	●35A	P 4
1.6														H 1
1.7														H 3
1.8														H 4
2.1											●37A	●37A	●37A	M 1
2.2											●30A	●30A	●30A	M 3
2.3														M 2
2.4														S 2
3.1											■60A	■60A	■60A	K 1
3.2											■50A	■50A	■50A	K 2
3.3											■40A	■40A	■40A	K 3
3.4											■25A	■25A	■25A	K 4
4.1														S 1
4.2														S 2
4.3														S 3
5.1														S 1
5.2														S 2
5.3														S 3
6.1											■100A	■100A	■100A	N 3
6.2											■65A	■65A	■65A	N 4
6.3											■100A	■100A	■100A	N 3
6.4											●50A	●50A	●50A	N 4
7.1											●120A	●120A	●120A	N 1
7.2											●150A	●150A	●150A	N 1
7.3														N 1
7.4														N 2
8.1														O
8.2														O
8.3														O
9.1														H
10.1														O

							
	M150	M151	M152	M200 1	M200 2	M200 3	
	-	-	-				
AMG	477	478	479	480	480	480	ISO
1.1				■			P 1
1.2				■			P 1
1.3				■		●	P 2
1.4				■		●	P 3
1.5				■		■	P 4
1.6				■		■	H 1
1.7				●		■	H 3
1.8				●		■	H 4
2.1				■		■	M 1
2.2				■		■	M 3
2.3				■		■	M 2
2.4				●		■	S 2
3.1				■		●	K 1
3.2				■		●	K 2
3.3				■		●	K 3
3.4				■		●	K 4
4.1				■		■	S 1
4.2				■		■	S 2
4.3				■		■	S 3
5.1				■		■	S 1
5.2				■		■	S 2
5.3				■		■	S 3
6.1					●		N 3
6.2					●		N 4
6.3					●		N 3
6.4					●		N 4
7.1					■		N 1
7.2					■		N 1
7.3					■		N 1
7.4					■		N 2
8.1							O
8.2							O
8.3							O
9.1							H
10.1							O



K300

- 切断刀片
- Bedame
- Cuchillas de tronzar
- Parting Off Inserts



K301

- 切断刀片
- Bedame
- Cuchillas de tronzar
- Parting Off Inserts



K302

- 切断刀片
- Bedame
- Cuchillas de tronzar
- Parting Off Inserts



K303

- 切断刀片
- Bedame
- Cuchillas de tronzar
- Parting Off Inserts



K304

- 切断刀片
- Bedame
- Cuchillas de tronzar
- Parting Off Inserts



K305

- 切断刀片
- Bedame
- Cuchillas de tronzar
- Parting Off Inserts



K300; K301; K302; K303; K304; K305	■	1.1	1.2	6.2	6.3		
	•	1.3	1.4	2.1	6.1	7.1	7.2

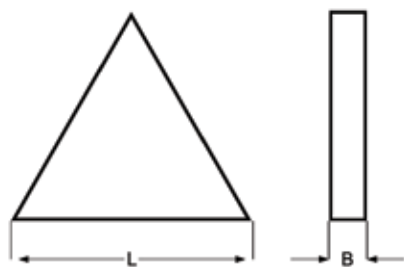

	K300	K301	K302	K303	K304	K305
	1.50 - 2.50	1.50 - 2.50	1.50 - 2.50	1.50 - 2.50	1.50 - 2.50	1.10 - 2.15

L	B	d min-max mm	K300	K301	K302	K303	K304	K305
23	1.10	9 - 17						K30523.0X1.1
23	1.30	18 - 26						K30523.0X1.3
23	1.50		K30023.0X1.5	K30123.0X1.5	K30223.0X1.5	K30323.0X1.5	K30423.0X1.5	
23	1.60	28 - 35						K30523.0X1.6
40	1.85	36 - 48						K30540.0X1.85
40	2.15	50 - 63						K30540.0X2.15
40	2.50		K30040.0X2.5	K30140.0X2.5	K30240.0X2.5	K30340.0X2.5	K30440.0X2.5	

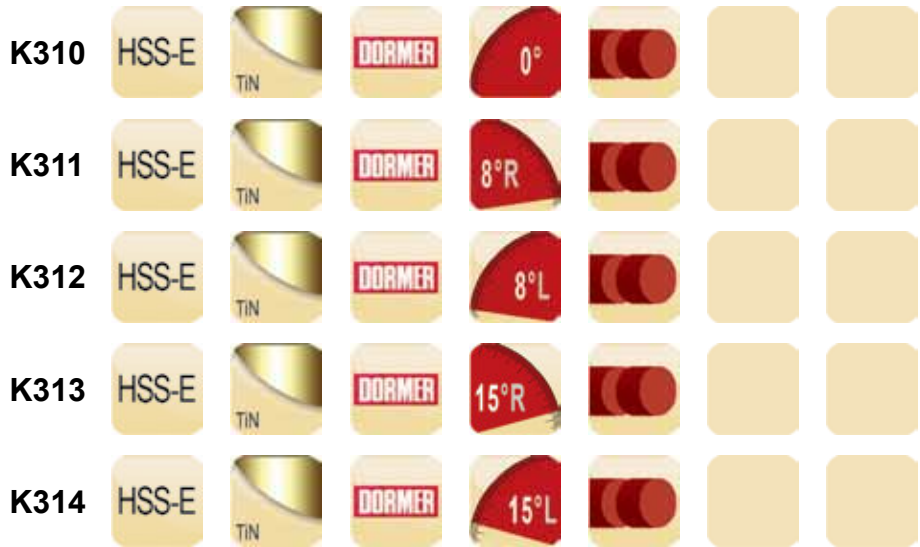

- K310**
- 切断刀片
 - Bedame
 - Cuchillas de tronzar
 - Parting Off Inserts



- K311**
- 切断刀片
 - Bedame
 - Cuchillas de tronzar
 - Parting Off Inserts



- K312**
- 切断刀片
 - Bedame
 - Cuchillas de tronzar
 - Parting Off Inserts



- K313**
- 切断刀片
 - Bedame
 - Cuchillas de tronzar
 - Parting Off Inserts



- K314**
- 切断刀片
 - Bedame
 - Cuchillas de tronzar
 - Parting Off Inserts



K310; K311; K312; K313; K314	■ 1.1	■ 1.2	■ 1.3	■ 2.1	■ 2.2	■ 6.1	■ 6.2	■ 6.3	■ 7.1	■ 7.2	■ 7.3
	■ 1.4	■ 1.5	■ 2.3	■ 7.4							

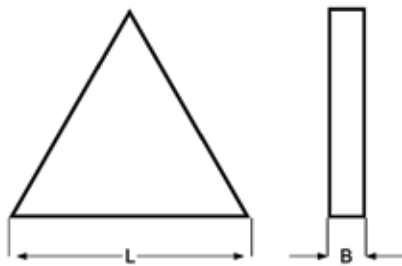

K310	K311	K312	K313	K314
23.00 - 40.00	23.00 - 40.00	23.00 - 40.00	23.00 - 40.00	23.00 - 40.00

L	B	K310	K311	K312	K313	K314
23	1.50	K31023.0X1.5	K31123.0X1.5	K31223.0X1.5	K31323.0X1.5	K31423.0X1.5
40	2.50	K31040.0X2.5	K31140.0X2.5	K31240.0X2.5	K31340.0X2.5	K31440.0X2.5



- K330**
- 切断刀片
 - Bedame
 - Cuchillas de tronzar
 - Parting Off Inserts



- K331**
- 切断刀片
 - Bedame
 - Cuchillas de tronzar
 - Parting Off Inserts



- K332**
- 切断刀片
 - Bedame
 - Cuchillas de tronzar
 - Parting Off Inserts



- K333**
- 切断刀片
 - Bedame
 - Cuchillas de tronzar
 - Parting Off Inserts







- K334**
- 切断刀片
 - Bedame
 - Cuchillas de tronzar
 - Parting Off Inserts

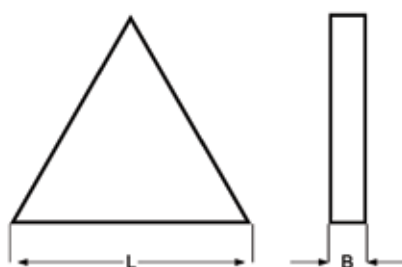

K330; K331; K332; K333; K334	▪	1.1	1.2	1.3	2.1	2.2	6.1	6.2	6.3	7.1	7.2	7.3
	•	1.4	1.5	2.3	7.4							



K330	K331	K332	K333	K334
				
23.00 - 40.00	23.00 - 40.00	23.00 - 40.00	23.00 - 40.00	23.00 - 40.00

L	B	K330	K331	K332	K333	K334
23	1.50	K33023.0X1.5	K33123.0X1.5	K33223.0X1.5	K33323.0X1.5	K33423.0X1.5
40	2.50	K33040.0X2.5	K33140.0X2.5	K33240.0X2.5	K33340.0X2.5	K33440.0X2.5



K100 • 切断刀杆

K101 • Porta-Ferramentas para Bedame

K102 • Portacuchillas de tronzar

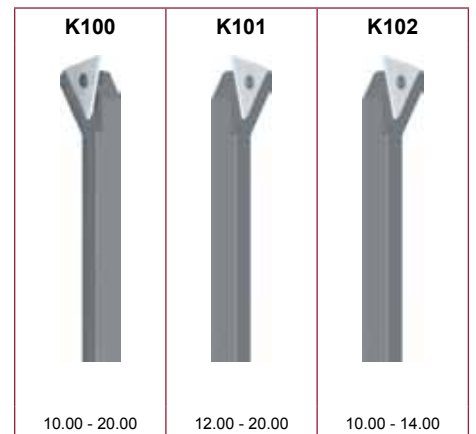
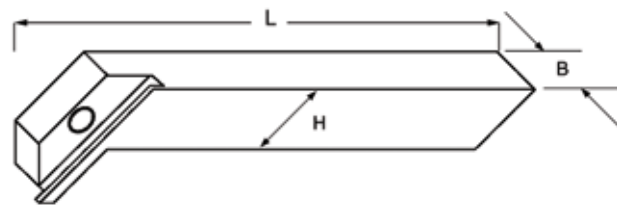

H	B	L	K100	K101	K102
10	10	125	K10010.0		K10210.0
12	12	125	K10012.0	K10112.0	
14	12	125			K10214.0
16	12	125	K10016.0	K10116.0	
20	12	125	K10020.0	K10120.0	



- K103**
- 切断刀杆
 - Porta-Ferramentas para Bedame
- K104**
- Portacuchillas de tronzar
 - Turning Insert Tool Holder

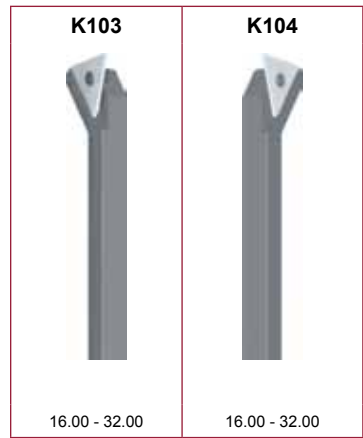
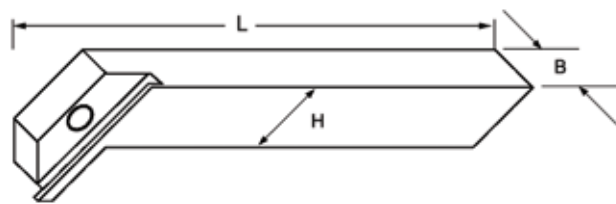

			K103	K104
H	B	L		
16	16	140	K10316.0	K10416.0
25	16	140	K10325.0	K10425.0
32	16	140	K10332.0	K10432.0

- K200** • 车削刀杆备件
- K201** • Componentes para porta-ferramentas
- K202** • Portacuchillas de tronzar
- K203** • Spare Parts for Turning Insert Tool Holders
- K204** • Spare Parts for Turning Insert Tool Holders



size	tool code	K200	K201	K202	K203	K204
1.5	Excentric	K200ECC1.5				
1.5	Spanner		K201SPAN1.5			
1.5-2.5	Pin			K2022.5X12.0		
2.5	Excentric				K203ECC2.5	
2.5	Spanner					K204SPAN2.5

K520



- 方形的白钢条h13
- Bits Quadrado h13
- Cuchillas Cuadrada h13
- Toolbits Square h13

K520

K520	▪	1.1	1.2	1.3	1.4	3.1	3.2	3.3	3.4	6.1	6.2	6.3
	•	1.5	2.1	2.2	6.4	7.1	7.2					

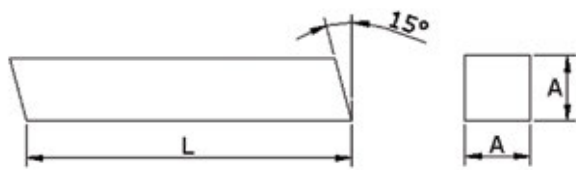

A	L	K520
4	63	K5204.0X63.0
4	100	K5204.0X100.0
5	63	K5205.0X63.0
5	160	K5205.0X160.0
6	63	K5206.0X63.0
6	100	K5206.0X100.0
6	160	K5206.0X160.0
6	200	K5206.0X200.0
7	200	K5207.0X200.0
8	63	K5208.0X63.0
8	100	K5208.0X100.0
8	160	K5208.0X160.0
8	200	K5208.0X200.0
10	63	K52010.0X63.0
10	100	K52010.0X100.0
10	125	K52010.0X125.0
10	160	K52010.0X160.0
10	200	K52010.0X200.0
12	100	K52012.0X100.0
12	160	K52012.0X160.0
12	200	K52012.0X200.0
14	100	K52014.0X100.0
14	160	K52014.0X160.0
14	200	K52014.0X200.0

A	L	K520
16	100	K52016.0X100.0
16	160	K52016.0X160.0
16	200	K52016.0X200.0
18	200	K52018.0X200.0
20	160	K52020.0X160.0
20	200	K52020.0X200.0
25	200	K52025.0X200.0
3/16	2.1/2	K5203/16X2.1/2
3/16	4"	K5203/16X4
1/4	2.1/2	K5201/4X2.1/2
1/4	4"	K5201/4X4
5/16	2.1/2	K5205/16X2.1/2
5/16	3"	K5205/16X3
5/16	4"	K5205/16X4
3/8	3"	K5203/8X3
3/8	4"	K5203/8X4
3/8	6"	K5203/8X6
7/16	3.1/2	K5207/16X3.1/2
1/2	4"	K5201/2X4
1/2	6"	K5201/2X6
5/8	4.1/2	K5205/8X4.1/2
5/8	6"	K5205/8X6
3/4	5"	K5203/4X5
1"	8"	K5201X8

K521



K521

- 圆形的白钢条h9
- Bits Redondo h9
- Cuchillas Redonda h9
- Toolbits Round h9

K521	▪	1.1	1.2	1.3	1.4	3.1	3.2	3.3	3.4	6.1	6.2	6.3
	•	1.5	2.1	2.2	6.4	7.1	7.2					

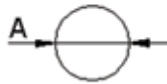
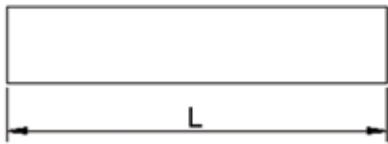

A	L	K521
3	100	K5213.0X100.0
4	80	K5214.0X80.0
4	100	K5214.0X100.0
5	100	K5215.0X100.0
5	160	K5215.0X160.0
6	100	K5216.0X100.0
6	160	K5216.0X160.0
6	200	K5216.0X200.0
8	100	K5218.0X100.0
8	160	K5218.0X160.0
8	200	K5218.0X200.0
10	100	K52110.0X100.0
10	160	K52110.0X160.0
10	200	K52110.0X200.0
12	100	K52112.0X100.0
12	160	K52112.0X160.0

A	L	K521
12	200	K52112.0X200.0
14	100	K52114.0X100.0
14	200	K52114.0X200.0
15	100	K52115.0X100.0
16	100	K52116.0X100.0
16	160	K52116.0X160.0
16	200	K52116.0X200.0
18	160	K52118.0X160.0
18	200	K52118.0X200.0
20	200	K52120.0X200.0
3/16	4"	K5213/16X4
5/16	4"	K5215/16X4
3/8	4"	K5213/8X4
1/2	4"	K5211/2X4
1/2	6"	K5211/2X6

K522



- 矩形的白钢条h13
- Bits Retângular h13
- Cuchillas Rectangular h13
- Toolbits Rectangle h13

K522

K522	▪	1.1	1.2	1.3	1.4	3.1	3.2	3.3	3.4	6.1	6.2	6.3
		1.5	2.1	2.2	6.4	7.1	7.2					

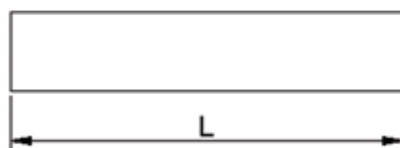

A	B	L	K522
10	3	200	K52210.0X3.0X200.0
12	3	90	K52212.0X3.0X90.0
12	3	200	K52212.0X3.0X200.0
20	3	200	K52220.0X3.0X200.0
10	4	100	K52210.0X4.0X100.0
10	4	120 (a)	K52210.0X4.0X120.0
10	4	200	K52210.0X4.0X200.0
12	4	200	K52212.0X4.0X200.0
16	4	160	K52216.0X4.0X160.0
16	4	200	K52216.0X4.0X200.0
20	4	200	K52220.0X4.0X200.0
12	5	90	K52212.0X5.0X90.0
12	5	200	K52212.0X5.0X200.0
18	5	200	K52218.0X5.0X200.0
20	5	200	K52220.0X5.0X200.0
8	6	70	K5228.0X6.0X70.0
10	6	200	K52210.0X6.0X200.0
12	6	200	K52212.0X6.0X200.0
14	6	140 (b+d)	K52214.0X6.0X140.0
16	6	200	K52216.0X6.0X200.0
18	6	140 (c)	K52218.0X6.0X140.0
20	6	200	K52220.0X6.0X200.0

A	B	L	K522
25	6	200	K52225.0X6.0X200.0
12	8	160	K52212.0X8.0X160.0
12	8	200	K52212.0X8.0X200.0
16	8	140 (d)	K52216.0X8.0X140.0
16	8	200	K52216.0X8.0X200.0
20	8	200	K52220.0X8.0X200.0
12	10	200	K52212.0X10.0X200.0
16	10	160	K52216.0X10.0X160.0
16	10	200	K52216.0X10.0X200.0
20	10	200	K52220.0X10.0X200.0
25	10	200	K52225.0X10.0X200.0
16	12	200	K52216.0X12.0X200.0
20	12	200	K52220.0X12.0X200.0
25	12	200	K52225.0X12.0X200.0
20	16	200	K52220.0X16.0X200.0
25	16	200	K52225.0X16.0X200.0
1/2	1/4	4	K5221/2X1/4X4
1/2	3/8	4	K5221/2X3/8X4
3/4	1/2	5	K5223/4X1/2X5
3/4	1/2	6	K5223/4X1/2X6
5/8	3/8	6	K5225/8X3/8X6

M150

- 锥形接套，油回火韧化处理
- Bucha Cônica Temperada
- Conos Morse endurecidos en aceite
- Sleeves Oil Toughened

K=外部, K1=内部
 K=Ext. K1=Int.
 k=Ext. K1=Int.
 K=Ext. K1=Int.

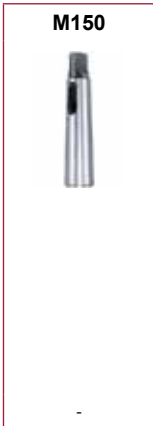

Nr.	K = Nr.	K1 = Nr.	M150
10	1	0	M1501-0
21	2	1	M1502-1
31	3	1	M1503-1
41	4	1	M1504-1
32	3	2	M1503-2
42	4	2	M1504-2
52	5	2	M1505-2
43	4	3	M1504-3
53	5	3	M1505-3
54	5	4	M1505-4
65	6	5	M1506-5

M151

- 锥柄接套, 淬火并磨削成形
- Bucha Cônica Temperada e Retificada
- Conos Morse endurecidos y cementados
- Sleeves Hardened and Ground

K=外部, K1=内部
 K=Ext. K1=Int.
 k=Ext. K1=Int.
 K=Ext. K1=Int.



Nr.	K = Nr.	K1 = Nr.	M151
10	1	0	M1511-0
21	2	1	M1512-1
31	3	1	M1513-1
41	4	1	M1514-1
32	3	2	M1513-2
42	4	2	M1514-2
52	5	2	M1515-2
43	4	3	M1514-3
53	5	3	M1515-3
54	5	4	M1515-4
65	6	5	M1516-5

M152

- 钻头提取
- Extrator de Brocas
- Expulsores de Brocas
- Drill Drift



Nr.	M152
0	M1520
1 + 2	M15212
3 + 4	M15234
4 + 5	M15245
6	M1526

M200

- 切削油
- Óleo de Corte
- Aceite de Corte
- Cutting Oil

1		▪	1.1	1.2	1.3	1.4	1.5	1.6	2.1	2.2	2.3	3.1	3.2	3.3	3.4	4.1	4.2	4.3	5.1	5.2	
		•	5.3																		
2		▪	7.1	7.2	7.3	7.4															
		•	6.1	6.2	6.3	6.4															
3		▪	1.5	1.6	1.7	1.8	2.1	2.2	2.3	2.4	4.1	4.2	4.3	5.1	5.2	5.3					
		•	1.2	1.3	1.4	3.1	3.2	3.3	3.4												



		M200
A		
1/4 Ltr. 12x	1 BLUE	M2000.25NR.1BLUE
1/4 Ltr. 12x	2 RED	M2000.25NR.2RED
1/4 Ltr. 12x	3 GREEN	M2000.25NR.3GREEN
1 Ltr.	1 BLUE	M2001.0NR.1BLUE
1 Ltr.	2 RED	M2001.0NR.2RED
1 Ltr.	3 GREEN	M2001.0NR.3GREEN
5 Ltr.	1 BLUE	M2005.0NR.1BLUE
5 Ltr.	2 RED	M2005.0NR.2RED
5 Ltr.	3 GREEN	M2005.0NR.3GREEN
20 Ltr.	1 BLUE	M20020.0NR.1BLUE



常用数据 中文 492 - 507

Informações Gerais - Português 508 - 523



























Información General - Español 524 - 539

General Information - English 540 - 555

481 - 560



通用图标 / Ícones Comuns
 Símbolos comunes / Common icons

材料 Material Material	涂层 Tratamento Superficial Tratamento Superficial Coating
 <p>硬质合金 Metal Duro Metal Duro Carbide</p>	
 <p>高速钢 Aço Rápido Acero rápido High Speed Steel</p>	
 <p>钴高速钢 Aço Rápido Cobalto Acero rápido al Cobalto High Speed Cobalt</p>	
 <p>粉末冶金钴高速钢 Aço Rápido Cobalto Sinterizado Acero rápido al Cobalto sinterizado HSS-E Powder Metallurgy Steel</p>	
 <p>高速钢/ 硬质合金 Aço Rápido / Metal Duro Acero Rápido / Metal Duro High Speed Steel/ Carbide</p>	
 <p>铝氮化铬 Nitreto de Alumínio Cromo Nitruro de Aluminio al Cromo Aluminium Chromium Nitride</p>	 <p>抛光处理 Acabamento polid Acabado pulido Polished Finish</p>
 <p>氮化钛硅 Nitreto de Titânio de Silício Nitruro de Titânio de Silício Titanium Silicon Nitride</p>	 <p>蒸气回火 Tratamento a Vapor Templado al vapor Steam Tempered</p>
 <p>光亮 Brilhante Brillante Bright</p>	 <p>青铜色 Bronze Bronce Bronze</p>
 <p>金刚石 Diamante Diamante Diamond</p>	 <p>镀铬 Cromo Cromado Chromium</p>
 <p>Super B</p>	 <p>氮化钛铝 Nitreto de Titânio Alumínio Nitruro de Titânio al Alumínio Titanium Aluminium Nitride</p>
 <p>碳氮化钛 Carbo Nitreto de Titânio Carbo-nitruro de Titânio Titanium Carbo-Nitride</p>	 <p>氮化钛 Nitreto de Titânio Nitruro de Titânio Titanium Nitride</p>
 <p>光亮 / 蒸气回火 Brilhante / Revenimento ao Vapor Billante / Revenido al vapor Bright/ Steam Tempered</p>	 <p>光亮 / 氮化钛 Brilhante/Nitreto de Titânio Brillante/nitruro de Titânio Bright/ Titanium Nitride</p>
 <p>蒸气回火 Revenimento ao Vapor / Bronze Revenido al Vapor / Bronce Steam Tempered/ Bronze</p>	 <p>氮化钛铝 - Top Nitreto de Titânio Alumínio - Top Nitruro de Titânio al Alumínio - Top Titanium Aluminium Nitride - Top</p>
 <p>Xceed</p>	 <p>Ti-phon for Hydra</p>
 <p>Alcrona</p>	 <p>Alcrona Top</p>
 <p>铝氮化钛碳 Carbo Nitreto de Alumínio Titânio Carbo-nitruro de Alumínio al Titânio Aluminium Titanium Carbo-Nitride</p>	 <p>铝氮化钛 Nitreto de Alumínio Titânio Nitruro de Alumínio al Titânio Aluminium Titanium Nitride</p>









通用图标 / Ícones Comuns Símbolos comunes / Common icons

加工方向 Direção Dirección Direction									
	右旋 Direita A derecha Right	左旋 Esquerda A izquierda left							
等级 Classificação Clasificación Rating									
	优异 Excelente Excelente Excellent	良好 Bom Bueno Good							
深度 Profundidade Profundidad Depth									
									

钻头图标 / Ícones de Brocas Iconos de taladrado / Drilling icons

顶角 Ângulo de Ponta ° de la punta Point Angle								
	60° 中心钻 Broca de Centrar 60° Centro 60° Centre 60°	圆弧刃中心钻 Broca de centrar com forma radial Forma con radio al centro Centre radius form	90° 多刃阶梯钻 Subland 90° Brocas bidiametrales 90° Subland 90°	180° 多刃阶梯钻 Subland 180° Brocas bidiametrales 180° Subland 180°				
铤孔度数 ° de Escareado ° de avellanado Countersink °								
	90° 阶梯钻 Broca Escalonada 90° Brocas escalonadas 90° Step Drill 90°	180° 阶梯钻 Broca Escalonada 180° Brocas escalonadas 180° Step Drill 180°						
形式 Forma Forma Form								
				持续心厚减薄 Alma continuamente adelgazada Alma continuamente adelgazada Continuously Thinned Web				
冷却 Refrigeração Refrigeración Coolant								
	内冷 Refrigeração Interna Refrigeración Interna Internal Coolant							

钻头图标 / Ícones de Brocas
 Iconos de taladrado / Drilling icons

柄部 Profundidade Profundidad Shank			
直柄 Haste Cilíndrica Mango cilíndrico Straight Shank		莫氏锥柄 Haste Cônica Mango cônico Morse taper shank	DIN 6535 HA
	DIN 6535 HE		柄带扁尾 Haste com lingueta de arraste Mango con espiga Shank with tang
	缩柄 Haste reduzida Mango reducido Reduced shank		DIN 6535 HB / HE
	柄带方身 Haste com quadrado de arraste Mango con cuadrado Shank with square		

标准 Norma Estándar Standard											
											
											

铰刀 - 铰钻图标 / Ícones para escareadores e alargadores Iconos para escariado - avellanado / Reaming - Countersink Icons

锥度 Escala de conicidade Escala de conicidad Taper Gradient											
公差 Tolerância Tolerancia Tolerance											
应用 Aplicação Aplicaciones Application	 铰孔 Escareador Avellanadores Countersink	 扩孔 Rebaixador Refrentadores Counterbore									
铰孔度数 Ângulo de escareado Ângulo de avellanado Countersink °											
					G314		M138				
柄部 Haste Mango Shank	 直柄 Haste cilíndrica Mango cilíndrico Straight		 莫氏锥柄 Haste Cônica Mango cônico Morse taper								
标准 Norma Estándar Standard											

螺纹加工图标 / Ícones de Machos
 Iconos de Roscado / Threading icons

螺纹形式

Tipo de Rosca
 Forma de Rosca
 Thread form



公制粗牙
 Métrica
 Métrica
 Metric coarse



公制细牙
 Métrica Fina
 Métrica fina
 Metric fine



美制粗牙螺纹
 Unified Coarse



美制细牙螺纹
 Unified Fine



美制螺纹
 Unified



英制管螺纹
 British standard pipe fastening - G series



美标NPT螺纹
 National taper pipe



美标NPTF螺纹
 National taper pipe dryseal



美标NPSF螺纹
 National taper pipe dryseal



美标NPSM螺纹
 National straight pipe mechanical



英标NPTF螺纹
 British association



英标BSF螺纹
 British standard fine



英标BSW螺纹
 British standard Whitworth



PG螺纹
 Armour pipe/ steel conduit



英标Rc螺纹
 British standard pipe taper - Rc Series

槽型

Geometria
 Geometria
 Flute Geometry



直槽
 Canal reto
 Canal Recto
 Straight Flute



螺尖
 Ponta Helicoidal
 Punta Helicoidal
 Spiral Point



挤压丝锥
 Laminadores
 Laminadores
 Fluteless - thread forming



挤压丝锥，油槽
 Laminadores com rasgos para lubrificação
 Laminadores con ranuras de lubricación
 Fluteless - thread forming - oil grooves



15° 螺旋槽
 Canal Helicoidal 15°
 Canal Helicoidal 15°
 Spiral flute 15°



27°



30°



35°



45°



40°

孔型

Tipo do furo
 Tipo de agujero
 Hole Type



通孔
 Furo passante
 Agujero pasante
 Through hole



盲孔
 Furo cego
 Agujero ciego
 Blind hole



通孔或盲孔
 Furo passante/cego
 Agujero pasante/ciego
 Through or blind hole

螺纹加工图标 / Ícones de Machos
 Iconos de Roscado / Threading icons

倒锥
 Chanfro
 Chaflán
 Chamfer

B
 3.5-5

C
 2-3

C
 2-3.5

E
 1.5-2

B 型切削锥
 Chanfro No. B
 Chaflán no. B
 Chamfer No. B

A 6-8
C 2-3

D 18-20
C 2-3

1.75XP

2.25XP

公差
 Tolerância
 Tolerancia
 Tolerance

2A

2B

6G

6GX

6g

6H

6HX

Class A

Medium

Normal

中等
 Média
 Mediano
 Medium

常规
 Normal
 Normal
 Normal

标准
 Norma
 Estándar
 Standard

DORMER
 DIN

DORMER
 ISO

DORMER
 ANSI

DIN
351

DIN
352

DIN
357

DIN
371

DIN
374

DIN
376

DIN
 371≤10
 376>12

DIN
382

DIN
2174

DIN
2181

DIN
2184-1

ISO
2283

ISO
2284

DIN
5156

DIN
5157

DIN
40432

DIN-EN
22568

ISO
529









ISO
2568



ANSI

ANSI
B94.9

BS
1127:
1950

铣刀图标 / Ícones de Fresas
 Iconos de Fresado / Milling icons

类型 Tipo Tipo Type			
	半精加工断屑槽 Semi-Acabamento Rompevirutas semiacabado Semi-finishing chipbreaker	细波形刃不对称断屑槽 Desbaste Fino Assimétrico Rompevirutas de perfil fino redondeado asimétrico Fine pitch asymmetrical rounded profile chipbreaker	适合加工低至高负荷的钢件 Fresa para aços de baixa a alta resistência Cuchillas para aceros de baja a alta resistencia For steels with low to high resistance
	 粗玉米齿断屑槽 Desbaste de perfil plano Rompevirutas de perfil grueso plano Coarse pitch flat profile chipbreaker	 粗波形刃不对称断屑槽 Desbaste de perfil arredondado assimétrico Rompevirutas de perfil grueso asimétrico Coarse pitch asymmetrical rounded profile chipbreaker	 适合加工较软的延展性材料 Fresa para materiais macios e maleáveis Cuchillas para materiales suaves y maleables For soft and malleable materials
	 粗波形刃断屑槽 Desbaste de perfil arredondado Rompevirutas de perfil grueso redondeado Coarse pitch rounded profile chipbreaker		

应用 Aplicação Aplicaciones Application				
	铣 P9 的槽 Rasgos P9 Ranurar Slotting P9	钻铣刀 Rasgos Ranurar Slotting	超精铣 Super-acabamento Super-acabado Super-finishing	精铣 Acabamento Acabado Finishing
	 粗铣 Desbaste Gran desbaste Roughing	 球头铣 Topo esférico Fresas radiales Ball nose	 刀尖带圆角 com Raio de Canto con radios en el extremo Corner radius	 高进给 Alto avanço Alto avance High feed
	 倒角 Chanframento Achaflanado Chamfering	 T 形槽 Forma - T Ranurados tipo "T" T-shaped	 半圆键槽 Woodruff Ranurados tipo Woodruff Woodruff	 燕尾槽 Rabo de andorinha Fresas angulares Dovetail
	 反燕尾槽 Rabo de andorinha invertido Fresas con ángulo inverso Inverse dovetail	 圆角铣 Fresa côncava Fresas frontales de perfil côncavo Corner rounding	 三面刃 / 圆锯 Corte 3 lados Fresas de ranurar de 3 cortes/sierras Side and face saws	 多 Multi
	 套式立铣刀 Fresa caracol Fresas frontales cilíndricas Shell end mill	 粗加工立铣刀 para Desbaste de Acabamento for roughing		

铣刀图标 / Ícones de Fresas Iconos de Fresado / Milling icons

加工方向 Direção Dirección Direction				
	横向、斜向、纵向 Rasgos, rampas e penetração Ranurar, fresado lateral, penetración Slotting, ramping, diving	横向、斜向 Rasgos, rampas Ranurar, fresado lateral Slotting, ramping	精铣 Acabamento Acabado Finishing	面铣 Fresamento Fresado Milling

切削长度 Comprimento de corte Longitud de corte Cut length					
	超短 Extra curta Extra corta Extra short		中等 Média Mediana Medium		超长 Extra longa Extra larga Extra long

直径公差 Tolerância de diâmetro Tolerancia del diámetro Diameter tolerance	d11	e8	h9	h10	h11	h12	k10	k12	js14	js16
---	-----	----	----	-----	-----	-----	-----	-----	------	------



直径是整数和半整数时为 e8，其余尺寸为 h10
 e8 diâmetros inteiros e intermediários, h10 outros
 Tol e8 en diâmetros enteros y medios, h10 en otros
 e8 full and half diameters, h10 others

螺旋角 Ângulo de hélice Ângulo de saída Ângulo de hélice Ângulo de saída Helix Angle/ Rake Angle	$\gamma 5^\circ$	$\gamma 15^\circ$	$\gamma 18^\circ$	$\lambda 0^\circ$ $\gamma 0^\circ$	$\lambda \neq$ $\gamma 10^\circ$	$\lambda 10^\circ$ $\gamma 10^\circ$	$\lambda 12^\circ$ $\gamma 10^\circ$	$\lambda 15^\circ$ $\gamma 10^\circ$	$\lambda 15^\circ$ $\gamma 15^\circ$	$\lambda 25^\circ$ $\gamma 0^\circ$	$\lambda 25^\circ$ $\gamma 20^\circ$
	$\lambda 30^\circ$ $\gamma -10^\circ$	$\lambda 30^\circ$ $\gamma 3^\circ$	$\lambda 30^\circ$ $\gamma 9^\circ$	$\lambda 30^\circ$ $\gamma 10^\circ$	$\lambda 30^\circ$ $\gamma 12^\circ$	$\lambda 30^\circ$ $\gamma 15^\circ$	$\lambda 30^\circ$ $\gamma 20^\circ$	$\lambda 35^\circ$ $\gamma 9^\circ$	$\lambda 35^\circ$ $\gamma 12^\circ$	$\lambda 40^\circ$ $\gamma -6^\circ$	$\lambda 40^\circ$ $\gamma 3^\circ$
	$\lambda 40^\circ$ $\gamma 4^\circ$	$\lambda 40^\circ$ $\gamma 10^\circ$	$\lambda 40^\circ$ $\gamma 15^\circ$	$\lambda 40^\circ$ $\gamma 20^\circ$	$\lambda 40^\circ$ $\gamma 25^\circ$	$\lambda 45^\circ$ $\gamma -10^\circ$	$\lambda 45^\circ$ $\gamma 12^\circ$	$\lambda 50^\circ$ $\gamma -26^\circ$	$\lambda 50^\circ$ $\gamma 3^\circ$		

刀齿 (z) N° de Cortes Dientes Teeth (z)	Z 1	Z 2	Z 3	Z 3-4	Z 3-5	Z 3-6	Z 4	Z 4-6	Z 4-8	Z 6-8	Z 6-10
	Z 6-12	Z 8-12	Z 10-12	Z 16-30	Z 28-44	Z 28-100	Z 40-200	Z 80-180	Z 100-140	Z 128-220	Z 160-350
	Z 4 ≠										

刀齿 (z) 4 不等距
 N° de Cortes 4 - Espaçamento Desigual
 Dientes 4 - Espacio irregular
 4 teeth - differential pitch

铣刀图标 / Ícones de Fresas
 Iconos de Fresado / Milling icons

柄部 Haste Mango Shank				
-------------------------------	--	--	--	--

--	--

标准 Norma Estándar Standard											

切断刀具图标 / Ícones de acessórios
 Iconos de cuchillas de tronzar / Parting off tool icons

刀刃角

Ângulo de corte
 ° de corte inclinado
 Edge angle



0°



8° 左手 - 右手
 8° Esquerda / Direita
 8° a izquierdas / a derechas
 8° left - right



15° 左手 - 右手
 15° Esquerda / Direita
 15° a izquierdas / a derechas
 15° left - right

刀片尺寸

Tamanho do
 inserto
 Tamaño
 Insert Size



23mm



40mm

切削方向

Direção de corte
 Dirección de corte
 Direction of cut



右手
 Direita
 A derecha
 Right



左手
 Esquerda
 A izquierda
 Left

应用

Aplicação
 Aplicaciones
 Application



切断
 Corte
 Corte
 Cut



切槽
 Ranhura
 Ranura
 Groove

形状

Forma
 Formas
 Form



圆形
 Redondo
 Redonda
 Round



方形
 Quadrado
 Cuadrada
 Square



矩形
 Retangular
 Rectangular
 Rectangular

公差

Tolerância
 Tolerancia
 Tolerance



h9



h13

标准

Norma
 Estándar
 Standard



DORMER



DIN
 4964A



DIN
 4964B



DIN
 4964D

中文		硬度	抗拉强度	ISO	
适用材料分组		HB	N/mm ²		
1. 钢	1.1 铁磁性低碳钢	< 120	< 400	P1	
	1.2 结构钢 表面渗碳钢	< 200	< 700	P1	
	1.3 普通碳钢	< 250	< 850	P2	
	1.4 合金钢	< 250	< 850	P3	
	1.5 合金钢 淬火回火钢	> 250 < 350	> 850 < 1200	P4	
	1.6 合金钢 淬火回火钢	> 350	> 1200 < 1620	H1	
	1.7 热处理合金钢	49-55HRC	> 1620	H3	
	1.8 淬火合金钢 耐磨钢	55-63HRC	> 1980	H4	
	2. 不锈钢	2.1 易切削不锈钢	< 250	< 850	M1
		2.2 奥氏体不锈钢	< 320	< 1100	M3
		2.3 铁素体 + 奥氏体, 马氏体不锈钢	< 300	< 1000	M2
		2.4 沉淀硬化不锈钢	> 320 < 410	> 1100 < 1400	S2
		3.1 灰铸铁	< 150	> 500	K1
		3.2 灰铸铁	> 150 < 300	> 500 < 1000	K2
	3. 铸铁	3.3 球墨铸铁, 可锻铸铁	< 200	< 700	K3
		3.4 球墨铸铁, 可锻铸铁	> 200 < 300	> 700 < 1000	K4
	4. 钛	4.1 纯钛	< 200	< 700	S1
4.2 钛合金		< 270	< 900	S2	
4.3 钛合金		> 270 < 350	> 900 ≤ 1250	S3	
5. 镍	5.1 纯镍	< 150	< 500	S1	
	5.2 镍合金	< 270	> 900	S2	
	5.3 镍合金	> 270 < 350	> 900 < 1200	S3	
6. 铜	6.1 紫铜	< 100	< 350	N3	
	6.2 β黄铜, 青铜	< 200	< 700	N4	
	6.3 α黄铜	< 200	< 700	N3	
	6.4 高强度青铜	< 470	< 1500	N4	
7. 铝 镁	7.1 纯铝, 纯镁	< 100	< 350	N1	
	7.2 铝合金, 硅含量 < 0.5%	< 150	< 500	N1	
	7.3 铝合金, 硅含量 > 0.5% < 10%	< 120	< 400	N1	
	7.4 铝合金, 硅含量 > 10% 晶须增强铝合金, 镁合金	< 120	< 400	N2	
8. 合成材料	8.1 热塑性塑料	---	---	O	
	8.2 热固性塑料	---	---	O	
9. 硬质材料	8.3 增强塑料	---	---	O	
	9.1 金属陶瓷	< 550	< 1700	H	
10. 石墨	10.1 标准石墨	---	< 100	O	

以不同标准表示的工件材料实例

AMG	EN	W.N.	DIN	BS	SS	USA	UNS	ISO
1.1	EN 10 025 - S235JR2	1.1015, 1.1013	Rf60, Rf100	230M67, 050A12	1160	Leaded Steels	G12120	P 1
1.2	EN 10 025 - S235JR2	1.1012, 1.1053, 1.7131	S37-2, 16MnCr5, S160-2	060A35, 080M40, 4360-50B	1312, 1412, 1914	135, 30	G10100	P 1
1.3	EN 10 025 - E295	1.1191, 1.0601	CK45, C60	080M46, 080A62	1550, 2142, 2172	1024, 1060, 1061	G10600	P 2
1.4	EN 10 083-1 - 42CrMo4 - EN 10 270-2	1.7225, 1.3505, 1.6582, 1.3247	42CrMo4, 100Cr6, 34CrNiMo6, S2-10-1-8	708M40/42, 817M40, 534A98, BM2, BT42	1672-04, 2090, 2244-02, 2541-02	4140, A2, 4340, M42, M2	G41270, G41470, T30102, T11342	P 3
1.5	EN ISO 4957 - H52-9-1-8	1.2510, 1.2713, 1.3247, 1.2080	100MnCrW12, 55NiCrMoV6, X210Cr12, S2-10-1-8	801, BM2, BT42, 826M40, 830M31	2244-04, 2541-03, 2850, 2722, 2723	01, L6, M42, D3, A2, M2, 4140, 8630	G96300, T30102, T11302, T30403, T11342	P 4
1.6	EN ISO 4957 - H52-9-1-8	1.2510, 1.2713, 1.3247, 1.2080	100MnCrW12, X210Cr12, S2-10-1-8	801, 826 M40, 830M31	2244-05, 2541-05, HARDOX 400	01, L6, M42, D3, 4140, 8130	T30403, G41400, J14047	H 1
1.7	EN ISO 4957 - H52-9-1-8	1.2510	100MnCrW4	BO1, BD3, BH13	HARDOX 500			H 3
1.8	EN ISO 4957 - X40CrMoV5-1	1.3343, 1.2344	S6-5-2, GX40CrMoV5-1	BM2, BH13	2242 HARDOX 600			H 4
2.1	EN 10 088-3 - X14CrMoS17	1.4305, 1.4104	X10CrNiSi89, X12CrMoS17	303 S21, 416 S37	2301, 2312, 2314, 2346, 2380	303, 416, 430F	S30300, S41600, S43020	M 1
2.2	EN 10 088-2-0-3 - 1.4301+AT	1.4301, 1.4541, 1.4571	X5CrNi189 X10CrNiMoTi1810	304 S15, 321 S17, 316 S, 320 S12	2310, 2333, 2337, 2343, 2353, 2377	304, 321, 316	S30400, S32100, S31600	M 3
2.3	EN 10 088-3 - 1.4460	1.4460, 1.4512, 1.4582	X8CrNiMo275, X4CrNiMoN6257	317 S16, 316 S16	2324, 2387, 2570	409, 430, 436	S40900, S4300, S43600	M 2
2.4	EN 1.4547	1.4547	X2CrNiMo20-18-6	HR41	2378	17-4PH	S31254	S 2
3.1	EN 1561 - EN-JL1030	0.6010, 0.6040	GG10, GG40	Grade150, Grade 400	0120, 0212, 0814	ASTM A48 class 20	F11401, F12801	K 1
3.2	EN 1561 - EN-JL1050	0.6025, 0.6040	GG25, GG40	Grade200, Grade 400	0125, 0130, 0140, 0217	ASTM A48 class 60	F12801, F14101	K 2
3.3	EN 1561 - EN-JL2040	0.7040, 0.7070, 0.8145, 0.8045	GG40, GGG70, GTS45-06, GTW45-07	GG40, GG40	0219, 0717, 0727, 0732, 0852	ASTM A220 grade 40010, ASTM A602 grade M4504	F22830, F20001	K 3
3.4	EN 1561 - EN-JL2050	0.7040, 0.7070, 0.8145, 0.8045	GG40, GGG70, GTS45-06, GTW45-07	GG40, GGG70, GTS45-06, GTW45-07	0221, 0223, 0737, 0854	ASTM A220 grade 90001, ASTM A602 grade M8501	F26230, 20005	K 4
4.1		3.7024LN	T199 8	TA1 to 9	T199 8	ASTM B265 grade 1	R50250	S 1
4.2		3.7164LN, 3.7119LN	TA16V4, TA16Sn2	TA10 to 14, TA17	TA16V4, TA16Sn2	AMS4928	R54790	S 2
4.3		3.7164LN, 3.7174LN, 3.7184LN	TA16V4, TA16V5Sn2, TA14MoSn2	TA10 to 13, TA28	TA16V5Sn2	AMS4928, AMS4971	R56400, R54790	S 3
5.1		2.4060, 2.4066	Nickel200, 270, N169 6	NA 11, NA12	N200, N270	Nickel200, Nickel230	N02200, N02230	S 1
5.2		2.4630LN, 2.4602, 2.4650LN	Nimonic 75, Monel 400, Hastelloy C, Inconel 600	HR203, 3027-76		Nimonic 75, Monel400, Hastelloy, Inconel600	N06075, N10002, N04400, N06600	S 2
5.3		2.4668LN, 2.4631LN, 2.6554LN	Inconel 718, Nimonic 80A, Waspaloy	HR8, HR401, 601		Inconel 718, 625, Nimonic 80	N07718, N07080, N06625	S 3
6.1	EN 1652 - CW004A	2.0060, 2.0070	E-Cu57, SE-Cu	C101	5010	101	C10100, C1020	N 3
6.2	EN 1652 - CW612N	2.0380, 2.0360, 2.1030, 2.1080	CuZn39Pb2, CuZn40, CuSn8, CuSn6Zn	CZ120, CZ109, PB104	5168		C28000, C37710	N 4
6.3	EN 1652 - CW608L	2.0321, 2.0260	CuZn37, CuZn28	CZ108, CZ106	5150		C2600, C27200	N 3
6.4			Ampcoo 18, Ampco 25	AB1 type	5238, JM7-20			N 4
7.1	EN 485-2 - EN AW-1070A	3.0255	A189 5	LMO, 1 B (1050A)	4005	EC, 1060, 1100	A91060, A91100	N 1
7.2	EN 755-2 - EN AW-5005	3.1355, 3.3525	AlCuMg2, AlMg2Mn0.8	LM5, 10, 12, N4 (5251)	4106, 4212	380, 520.0, 520.2, 2024, 6061	A03800, A05200, A92024	N 1
7.3	EN 1706 - EN AC-42000	3.2162.05, 3.2341.01	GD-ALSi8Cu, G-ALSi8Mg	LM2, 4, 16, 18, 21, 22, 24, 25, 26, 27, 1-109	4244	319.0, 333.0, 319.1, 356.0	A03190, A03330, C35600	N 1
7.4	SS-EN 1706 - EN AC-47000	3.2581.01	G-ALSi18, G-ALSi12	LM6, 12, 13, 20, 28, 29, 30	4260, 4261, 4262	4032, 222.1, A332.0	A94032, A02220, A13320	N 2
8.1			Polystyrene, Nylon, PVC Cellulose, Acetate & Nitrate			Polystyrene, Nylon, PVC		O
8.2			Ebonite, Tufnol, Bakelite			Bakelite		O
8.3			Kevlar, Pinned Circuit boards			Kevlar		O
9.1			Ferroc, Ferroitanit					H
10.1			Graphite					O

切削速度表



		Vc															
m/Min		5	8	10	15	20	25	30	40	50	60	70	80	90	100	110	150
Feet/Min		16	26	32	50	66	82	98	130	165	197	230	262	296	330	362	495
Ø		RPM															
mm	inch																
1,00		1592	2546	3183	4775	6366	7958	9549	12732	15916	19099	22282	25465	28648	31831	35014	47747
1,50		1061	1698	2122	3183	4244	5305	6366	8488	10610	12732	14854	16977	19099	21221	23343	31831
2,00		796	1273	1592	2387	3183	3979	4775	6366	7958	9549	11141	12732	14324	15916	17507	23873
2,50		637	1019	1273	1910	2546	3183	3820	5093	6366	7639	8913	10186	11459	12732	14006	19099
3,00		531	849	1061	1592	2122	2653	3183	4244	5305	6366	7427	8488	9549	10610	11671	15916
3,18	1/8	500	801	1001	1501	2002	2502	3003	4004	5005	6006	7007	8008	9009	10010	11011	15015
3,50		455	728	909	1364	1819	2274	2728	3638	4547	5457	6366	7276	8185	9095	10004	13642
4,00		398	637	796	1194	1592	1989	2387	3183	3979	4775	5570	6366	7162	7958	8754	11937
4,50		354	566	707	1061	1415	1768	2122	2829	3537	4244	4951	5659	6366	7074	7781	10610
4,76	3/16	334	535	669	1003	1337	1672	2006	2675	3344	4012	4681	5350	6018	6687	7356	10031
5,00		318	509	637	955	1273	1592	1910	2546	3183	3820	4456	5093	5730	6366	7003	9549
6,00		265	424	531	796	1061	1326	1592	2122	2653	3183	3714	4244	4775	5305	5836	7958
6,35	1/4	251	401	501	752	1003	1253	1504	2005	2506	3008	3509	4010	4511	5013	5514	7519
7,00		227	364	455	682	909	1137	1364	1819	2274	2728	3183	3638	4093	4547	5002	6821
7,94	5/16	200	321	401	601	802	1002	1203	1604	2004	2405	2806	3207	3608	4009	4410	6013
8,00		199	318	398	597	796	995	1194	1592	1989	2387	2785	3183	3581	3979	4377	5968
9,00		177	283	354	531	707	884	1061	1415	1768	2122	2476	2829	3183	3537	3890	5305
9,53	3/8	167	267	334	501	668	835	1002	1336	1670	2004	2338	2672	3006	3340	3674	5010
10,00		159	255	318	477	637	796	955	1273	1592	1910	2228	2546	2865	3183	3501	4775
11,11	7/16	143	229	287	430	573	716	860	1146	1433	1719	2006	2292	2579	2865	3152	4298
12,00		133	212	265	398	531	663	796	1061	1326	1592	1857	2122	2387	2653	2918	3979
12,70	1/2	125	201	251	376	501	627	752	1003	1253	1504	1754	2005	2256	2506	2757	3760
14,00		114	182	227	341	455	568	682	909	1137	1364	1592	1819	2046	2274	2501	3410
14,29	9/16	111	178	223	334	446	557	668	891	1114	1337	1559	1782	2005	2228	2450	3341
15,00		106	170	212	318	424	531	637	849	1061	1273	1485	1698	1910	2122	2334	3183
15,88	5/8	100	160	200	301	401	501	601	802	1002	1203	1403	1604	1804	2004	2205	3007
16,00		99	159	199	298	398	497	597	796	995	1194	1393	1592	1790	1989	2188	2984
17,46	11/16	91	146	182	273	365	456	547	729	912	1094	1276	1458	1641	1823	2005	2735
18,00		88	141	177	265	354	442	531	707	884	1061	1238	1415	1592	1768	1945	2653
19,05	3/4	84	134	167	251	334	418	501	668	835	1003	1170	1337	1504	1671	1838	2506
20,00		80	127	159	239	318	398	477	637	796	955	1114	1273	1432	1592	1751	2387
24,00		66	106	133	199	265	332	398	531	663	796	928	1061	1194	1326	1459	1989
25,00		64	102	127	191	255	318	382	509	637	764	891	1019	1146	1273	1401	1910
27,00		59	94	118	177	236	295	354	472	589	707	825	943	1061	1179	1297	1768
30,00		53	85	106	159	212	265	318	424	531	637	743	849	955	1061	1167	1592
32,00		50	80	99	149	199	249	298	398	497	597	696	796	895	995	1094	1492
36,00		44	71	88	133	177	221	265	354	442	531	619	707	796	884	973	1326
40,00		40	64	80	119	159	199	239	318	398	477	557	637	716	796	875	1194
50,00		32	51	64	95	127	159	191	255	318	382	446	509	573	637	700	955

HV Vickers	HRC Rockwell	HB Brinell	N/ mm ²	Tons/ sq. in.
940	68			
900	67			
864	66			
829	65			
800	64			
773	63			
745	62			
720	61			
698	60			
675	59			
655	58		2200	142
650		618	2180	141
640		608	2145	139
639	57	607	2140	138
630		599	2105	136
620		589	2070	134
615	56	584	2050	133
610		580	2030	131
600		570	1995	129
596	55	567	1980	128
590		561	1955	126
580		551	1920	124
578	54	549	1910	124
570		542	1880	122
560	53	532	1845	119
550		523	1810	117
544	52	517	1790	116
540		513	1775	115
530		504	1740	113
527	51	501	1730	112
520		494	1700	110
514	50	488	1680	109
510		485	1665	108
500		475	1630	105
497	49	472	1620	105
490		466	1595	103
484	48	460	1570	102
480		456	1555	101
473	47	449	1530	99
470		447	1520	98
460		437	1485	96
458	46	435	1480	96
450		428	1455	94
446	45	424	1440	93
440		418	1420	92

HV Vickers	HRC Rockwell	HB Brinell	N/ mm ²	Tons/ sq. in.
434	44	413	1400	91
423	43	402	1360	88
413	42	393	1330	86
403	41	383	1300	84
392	40	372	1260	82
382	39	363	1230	80
373	38	354	1200	78
364	37	346	1170	76
355	36	337	1140	74
350		333	1125	73
345	35	328	1110	72
340		323	1095	71
336	34	319	1080	70
330		314	1060	69
327	33	311	1050	68
320		304	1030	67
317	32	301	1020	66
310	31	295	995	64
302	30	287	970	63
300		285	965	62
295		280	950	61
293	29	278	940	61
290		276	930	60
287	28	273	920	60
285		271	915	59
280	27	266	900	58
275		261	880	57
272	26	258	870	56
270		257	865	56
268	25	255	860	56
265		252	850	55
260	24	247	835	54
255	23	242	820	53
250	22	238	800	52
245		233	785	51
243	21	231	780	50
240		228	770	50
235		223	755	49
230		219	740	48
225		214	720	47
220		209	705	46
215		204	690	45
210		199	675	44
205		195	660	43
200		190	640	41

公差



公差	Ø mm							
	> 1 ≤ 3	> 3 ≤ 6	> 6 ≤ 10	> 10 ≤ 18	> 18 ≤ 30	> 30 ≤ 50	> 50 ≤ 80	> 80 ≤ 120
	µm							
e8	-14 / -28	-20 / -38	-25 / -47	-32 / -59	-40 / -73	-50 / -89	-60 / -106	-72 / -126
f6	-6 / -12	-10 / -18	-13 / -22	-16 / -27	-20 / -33	-25 / -41	-30 / -49	-36 / -58
f7	-6 / -16	-10 / -22	-13 / -28	-16 / -34	-20 / -41	-25 / -50	-30 / -60	-36 / -71
h6	0 / -6	0 / -8	0 / -9	0 / -11	0 / -13	0 / -16	0 / -19	0 / -22
h7	0 / -10	0 / -12	0 / -15	0 / -18	0 / -21	0 / -25	0 / -30	0 / -35
h8	0 / -14	0 / -18	0 / -22	0 / -27	0 / -33	0 / -39	0 / -46	0 / -54
h9	0 / -25	0 / -30	0 / -36	0 / -43	0 / -52	0 / -62	0 / -74	0 / -87
h10	0 / -40	0 / -48	0 / -58	0 / -70	0 / -84	0 / -100	0 / -120	0 / -140
h11	0 / -60	0 / -75	0 / -90	0 / -110	0 / -130	0 / -160	0 / -190	0 / -220
h12	0 / -100	0 / -120	0 / -150	0 / -180	0 / -210	0 / -250	0 / -300	0 / -350
k10	+40 / 0	+48 / 0	+58 / 0	+70 / 0	+84 / 0	+100 / 0	+120 / 0	+140 / 0
k12	+100 / 0	+120 / 0	+150 / 0	+180 / 0	+210 / 0	+250 / 0	+300 / 0	+350 / 0
m7	+2 / +12	+4 / +16	+6 / +21	+7 / +25	+8 / +29	+9 / +34	+11 / +41	+13 / +48
js14	+/- 125	+/- 150	+/- 180	+/- 215	+/- 260	+/- 310	+/- 370	+/- 435
js16	+/- 300	+/- 375	+/- 450	+/- 550	+/- 650	+/- 800	+/- 950	+/- 1100
H7	+10 / 0	+12 / 0	+15 / 0	+18 / 0	+21 / 0	+25 / 0	+30 / 0	+35 / 0
H8	+14 / 0	+18 / 0	+22 / 0	+27 / 0	+33 / 0	+39 / 0	+46 / 0	+54 / 0
H9	+25 / 0	+30 / 0	+36 / 0	+43 / 0	+52 / 0	+62 / 0	+74 / 0	+87 / 0
H12	+100 / 0	+120 / 0	+150 / 0	+180 / 0	+210 / 0	+250 / 0	+300 / 0	+350 / 0
P9	-6 / -31	-12 / -42	-15 / -51	-18 / -61	-22 / -74	-26 / -86	-32 / -106	-37 / -124

1µm = 0.001mm

钻头

钻削的注意事项

1. 必须根据要加工的材料、机床的性能和所用的冷却液，来选择最适合该加工场合的钻头。
2. 若在工件和机床主轴之间存在浮动现象，则不但会损坏钻头，也会损坏工件和机床。必须在任何时候都确保最高的稳固性，选择尽可能最短的钻头可提高稳固性。
3. 钻夹头是钻削加工中的一个重要因素，不允许钻头在钻夹头内有任何的滑动或窜动现象。
4. 建议按照特定钻削加工的要求，采用合适的冷却液或润滑液。使用冷却液或润滑液时，要确保足够的流量，特别是在钻尖部分。
5. 为了确保正确的钻削加工，钻削时必须能顺利排屑，切屑不得堵塞在钻槽内。
6. 在对钻头进行重磨时，要始终确保磨出正确的钻尖几何形状，并且要把所有的磨损部分都磨掉。

钻孔尺寸

随着钻头的几何形状、材料和涂层的不断发展，有可能用钻头打出尺寸更精确的孔。一般来说，具有标准几何形状的钻头可打出 H12 的孔。如果钻头拥有综合性的优异配置，则在其他条件都有利的情况下，甚至可以打出 H8 的孔。为了对此有更好的了解，下面给出了各种钻头类型以及它们可达到的钻孔公差：

- HSS 常规用途钻头 – H12
- HSS / HSS-E 抛物线槽形深孔钻头 – H10
- 整体硬质合金高性能涂层 – H8/H9

深孔钻削的策略

在钻削深孔时，可采用不同的方法来钻到所要求的深度。下面介绍了四种方法，均可钻到 10 x 钻头直径的深度。

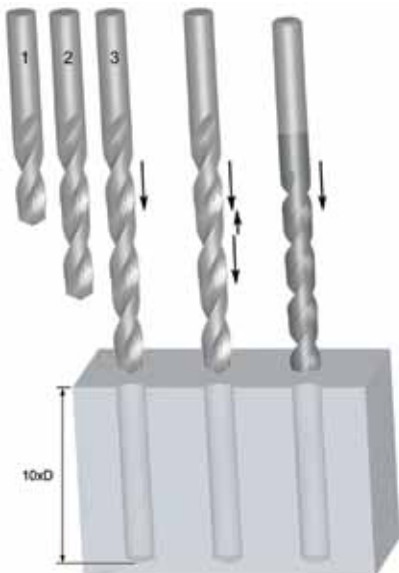

	成组钻削	成组钻削
钻头数量	3 (2.5 x D, 6 x D, 10 x D)	2 (2.5 x D, 10 x D)
钻头类型	标准几何形状， 常规用途	标准几何形状， 常规用途
+ / -	代价高 耗时较多	较高性价比 较快

	反复退刀的钻削	一次进刀的钻削
钻头数量	1 (10 x D)	1 (10 x D)
钻头类型	标准几何形状， 常规用途	专用刀具
+ / -	耗时较多	高性价比 快速

钻削的问题解答

问题	原因	纠正
扁尾部分断裂或扭曲	钻头柄部和夹套之间的配合较差	确保钻头柄部和夹套表面都比较干净，没有损坏现象
钻心部分有裂痕	进给量太大	把进给量减少到最佳值
	初始后角太小	重磨至正确规范
	心厚减薄过多	重磨至正确规范
	钻尖部分受到过大的撞击	防止钻尖部分受到撞击，在把锥柄钻插入 / 拔出主轴时要特别注意
钻尖外角磨损	切削速度太高	把切削速度降低到最佳值，或许可以增大进给量
钻尖外角崩裂	工件夹持不稳固	不使工件有走动现象
切削刃有崩口现象	初始后角太大	重磨至正确规范
钻头在钻槽根部断裂	切屑堵在钻槽内	采用多次退刀法或用成组钻头来加工
	钻头打滑	确保钻头牢固地夹持在钻夹头和主轴内
钻孔表面有螺旋状痕迹	进给量太小	增大进给量
	定位精度较差	钻孔前先用定心钻加工
钻孔尺寸过大	钻尖几何形状不正确	检查钻尖形状
	排屑情况不佳	调整切削速度、进给量和退刀次数，以更好地控制切屑形状

铰刀

铰削的注意事项

为了得到最好的铰削效果，必须使铰刀能真正地进行“工作”。常见的错误是在预钻孔时留下的铰削余量太少。如果铰削余量不足的话，铰刀在加工时实际上只是在对孔壁作摩擦而不是切削。这样铰刀会很快磨损，也就丧失了正确的直径尺寸。同样重要的是，预钻孔的铰削余量也不能留得太多(见后面的铰削余量表)。

1. 为特定应用场合选择最合适的铰刀型号，并选择最佳的速度和进给量，确保预钻孔有正确的直径尺寸。
2. 工件必须夹持牢固，机床主轴不应有间隙。
3. 夹持直柄铰刀的夹头必须是高质量的，若铰刀在夹头内滑动的话，在作自动进给时铰刀可能会断裂。
4. 应使铰刀伸出机床主轴的悬伸量尽可能最短。
5. 采用推荐的冷却液以延长铰刀的寿命，并确保冷却液能到达切削刃部位。由于铰削不是重负荷切削，采用 40 : 1 稀释的乳化油一般就能满足要求。在对灰铸铁作干切削时，也可采用压缩空气来作冷却。
6. 不要让切屑堵塞铰刀的容屑槽。
7. 在对铰刀进行重磨之前，先把它放在双顶尖之间检查其同心度。在大部分情况下，只需对铰刀的导锥部分进行修磨。
8. 保持铰刀的锋利度，经常修磨铰刀会有较好的经济性。要知道铰刀只用其锥形部分来进行切削工作，而不是其圆柱刃带部分，这一点很重要。因此只有铰刀的锥形部分需要修磨。修磨的精度对铰孔质量和铰刀寿命都有很大影响。

铰削余量

推荐的铰削余量与工件材料和预钻孔的表面光洁度有关。下表给出了确定铰削余量的一般原则：

铰孔尺寸 (mm)	采用预钻孔时	采用预扩孔时	铰孔尺寸 (英寸)	采用预钻孔时	采用预扩孔时
小于 4	0.1	0.1	小于 3/16	0.004	0.004
大于 4 至 11	0.2	0.15	3/16 至 1/2	0.008	0.006
大于 11 至 39	0.3	0.2	1/2 至 1 1/2	0.010	0.008
大于 39 至 50	0.4	0.3	1 1/2 至 2	0.016	0.010

公差极限



1. 在标准铰刀的切削直径上

在测量直径 (d1) 时，要横跨圆周刃带来测量紧邻铰刀导锥或圆锥导向的圆柱部分尺寸。铰刀公差按照 DIN 1420，可加工出 H7 的孔。

铰刀公差			
直径 (mm)		公差极限 (mm)	
大于	小于等于	上公差 +	下公差 +
	3	0.008	0.004
3	6	0.010	0.005
6	10	0.012	0.006
10	18	0.015	0.008

铰刀公差			
直径 (mm)		公差极限 (mm)	
大于	小于等于	上公差 +	下公差 +
18	30	0.017	0.009
30	50	0.021	0.012
50	80	0.025	0.014

2. 在 H7 的孔上

对于精加工的孔来说，最常见的公差就是 H7 (见下表)。若需其他的公差，可用第 3 点下面的图表来计算出铰刀的公差位置和公差带宽度。

孔的公差			
直径 (mm)		公差极限 (mm)	
大于	小于等于	上公差 +	下公差 +
	3	0.010	0
3	6	0.012	0
6	10	0.015	0
10	18	0.018	0

孔的公差			
直径 (mm)		公差极限 (mm)	
大于	小于等于	上公差 +	下公差 +
18	30	0.021	0
30	50	0.025	0
50	80	0.030	0

3. 如果需要铰出特殊的孔公差，比如 D8，可利用这里的经验公式来确定此特殊铰刀的尺寸：

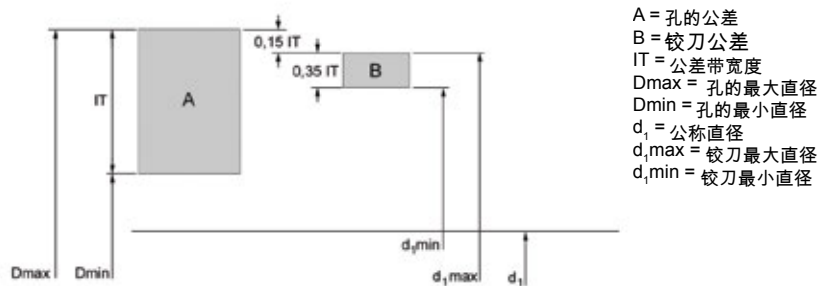

公差带宽度 (微米)	直径的公差带宽度							
	大于 1 至 3	大于 3 至 6	大于 6 至 10	大于 10 至 18	大于 18 至 30	大于 30 至 50	大于 50 至 80	大于 80 至 120
IT5	4	5	6	8	9	11	13	15
IT6	6	8	9	11	13	16	19	22
IT7	10	12	15	18	21	25	30	35
IT8	14	18	22	27	33	39	46	54
IT9	25	30	36	43	52	62	74	87
IT10	40	48	58	70	84	100	120	140
IT11	60	75	90	110	130	160	190	220
IT12	100	120	150	180	210	250	300	350

例如：10 mm 的孔，公差为 D8，最大直径 = 10.062，最小直径 = 10.040，孔公差 (IT8) = 0.022

最大尺寸极限：0.15 x 孔公差 (IT8) = 0.0033，圆整后 = 0.004

最小尺寸极限：0.35 x 孔公差 (IT8) = 0.0077，圆整后 = 0.008

铰刀最大尺寸极限 = 10.062 - 0.004 = 10.058

铰刀最小尺寸极限 = 10.058 - 0.008 = 10.050

铰削的问题解答

问题	原因	纠正
扁尾部分断裂或扭曲	铰刀柄部和夹套之间的配合较差	确保铰刀柄部和夹套表面都比较干净，没有损坏现象
铰刀磨损较快	铰削余量太少	增加铰削余量
铰孔直径过大	切削刃的高度偏差过大	重磨至正确的尺寸规范
	机床主轴有位移现象	修理并纠正主轴的位移
	刀具夹头偏斜	更换刀具夹头
	铰刀柄部损坏	更换铰刀或重磨柄部
	铰刀的圆度不好	更换或重磨铰刀
	导锥角不对称	重磨至正确的尺寸规范
	进给量过大或切削速度过高	根据样本来调整切削条件
铰孔直径过小	铰削余量太少	增加铰削余量
	铰削时产生过多热量，致使孔先胀大再收缩	加大冷却液流量
	铰刀磨损，导致其直径变小	重磨至正确的尺寸规范
	进给量太小或切削速度太低	根据样本来调整切削条件
	预钻孔太小	把孔钻大一点以减少铰削余量
铰出的孔呈椭圆形或圆锥形	机床主轴有位移现象	修理并纠正主轴的位移
	铰刀和孔之间没有对正	把铰刀与孔对正
	导锥角不对称	重磨至正确的尺寸规范
铰孔光洁度较差	铰削余量太大	把孔钻大一点以减少铰削余量
	铰刀已磨损	重磨至正确的尺寸规范
	切削前角太小	重磨至正确的尺寸规范
	乳化液或切削油被过度稀释	提高其浓度百分比
	进给量太小和 / 或速度太低	根据样本来调整切削条件
	切削速度太高	根据样本来调整切削条件
铰刀转动受阻并断裂	铰刀已磨损	重磨至正确的尺寸规范
	铰刀的倒锥度太小	检查并替换 / 修磨刀具
	铰刀的刃带太宽	检查并替换 / 修磨刀具
	工件材料对铰刀有挤压趋向	采用可调节铰刀，以对此变位现象作适当补偿
	预钻孔太小	把孔钻大一点以减少铰削余量
	工件材料的均质性不好，含有较硬的夹杂物	采用整体硬质合金铰刀

螺纹加工

螺纹加工的注意事项

成功的螺纹加工取决于多种因素，所有这些因素都会影响到最终产品的质量。

1. 根据工件材料和螺孔类型，即通孔还是盲孔，在材料分类图表中选择正确的丝锥型号。
2. 确保工件被牢固夹紧，工件的侧向移动可能导致丝锥断裂，或导致较差的螺纹加工质量。
3. 在相应的样本页上选择正确的底孔钻头尺寸。要始终确保把工件材料的加工硬化现象压制在最低程度。
4. 根据相应的样本页来选择正确的切削速度。
5. 采用合适的切削液，以进行正确的螺纹加工。
6. 在数控机床上进行螺纹加工时，确保给程序选择正确的进给量。如果采用攻丝附件，建议的进给量为螺距的 95% 至 97%，这样可使丝锥走出它自己的螺距。
7. 若有可能的话，应把丝锥夹持在优质的、有扭矩限制的攻丝附件内，确保丝锥可在轴向作自由移动，并使丝锥与孔保持垂直。万一碰到丝锥在盲孔内“触底”的意外情况，也能保护丝锥不会断裂。
8. 确保丝锥平滑地进入孔内，因为不均匀的进刀会导致螺孔出现“喇叭口”现象。

丝锥公差与公差内螺纹（螺母）

公差等级，丝锥			公差，内螺纹（螺母）					应用范围
ISO	DIN	ANSI BS	4 H	5 H	6 H	7 H	8 H	
ISO 1	4 H	3 B	4 H	5 H				适合无容差
ISO 2	6 H	2 B	4 G	5 G	6 H			一般适用
ISO 3	6 G	1 B			6 G	7 H	8 H	适合带较大容差
-	7 G	-				7 G	8 G	不适用于以下处理和涂层

丝锥钻孔的问题汇总

问题	原因	纠正
尺寸偏大	公差带不正确	选择螺纹公差带偏下一点的丝锥
	轴向进给不正确	把进给率降低5-10%，或是增加丝锥夹头上的压力
	所用丝锥的型号有误	用罗建丝锥来加工通孔，用螺旋槽丝锥来加工盲孔，用涂层丝锥来防止产生积屑瘤。可根据产品样本或选刀光盘来选择正确的替代丝锥。
	丝锥与孔的中心没有对正	检查丝锥夹头，使丝锥的中心正确对正孔的位置。
	缺少冷却	采用较好的冷却液，以防止产生积屑瘤。可参见本手册有关冷却液的章节
	丝锥的切削速度太慢	按照产品样本或选刀光盘的推荐来选择切削速度
尺寸偏小	所用的丝锥型号有误	用螺尖丝锥来加工通孔，用螺旋槽丝锥来加工盲孔，用涂层丝锥来防止产生积屑瘤，选用前角较大的丝锥。可根据产品样本或选刀光盘来选择正确的替代丝锥
	公差带不正确	选择螺纹公差带偏上一点的丝锥，尤其是在加工铸铁、不锈钢等极少有尺寸偏大倾向的材料时
	缺少冷却或冷却液不正确	采用较好的冷却液，以防止切屑堵塞在孔内。可参见本手册中有关冷却液的章节
	攻丝底孔过小	底孔钻头的直径采用最大值，可参见底孔钻头推荐表
	工件材料在攻丝后发生收缩	按照产品样本或选刀光盘的推荐来选择正确的替代丝锥
刀刃崩口	所用丝锥的型号有误	选用前角较小的丝锥，选用切削锥较长的丝锥。用螺尖丝锥来加工通孔，用螺旋槽丝锥来加工盲孔，以防止切屑堵塞。可根据产品样本或选刀光盘来选择正确的替代丝锥
	缺少冷却或冷却液不正确	采用较好的冷却液，以防止产生积屑瘤。可参见本手册中有关冷却液的章节
	丝锥碰到孔的底部	增加钻孔深度，或是减少攻丝深度
	工件表面有加工硬化现象	降低切削速度，适用涂层丝锥，采用较好的冷却液。可参见本手册有关不锈钢加工的章节。
	丝锥在退刀时有堵屑现象	在丝锥退刀过程中要避免突然的回转动作
	切削锥与孔的进口处相撞	检查轴向位置，减少丝锥顶尖和孔中心的轴向偏差
攻丝底孔的尺寸太小	底孔钻头的直径采用最大值，可参见底孔钻头推荐表	

丝锥钻孔的问题汇总

问题	原因	纠正
断裂	丝锥磨损	换用新丝锥或对老丝锥进行重磨
	缺少冷却	选用较好的冷却液，以防止产生积屑瘤和切屑堵塞的现象。可参见本手册中有关润滑液的章节
	丝锥碰到孔的底部	增加钻孔深度，或减少攻丝深度
	丝锥的切削速度太高	降低丝锥的切削速度，可按照产品样本或选刀光盘的推荐来选择正确的丝锥切削速度
	工件表面有加工硬化现象	降低切削速度，使用涂层丝锥，采用较好的冷却液。可参见本手册中有关不锈钢加工的章节
	攻丝底孔的尺寸太小	底孔钻头的直径采用最大值，可参见底孔钻头推荐表
	丝锥的扭矩太大	选用带扭矩调节离合器的攻丝附件来夹持丝锥
	工件材料在攻丝后发生收缩	按照产品样本或选刀光盘的推荐来选择正确的替代丝锥
丝锥磨损快	所用丝锥的型号有误	选用前角较小的丝锥，或是选用后角较大的丝锥，或是选用切削锥较长的丝锥。也可选用涂层丝锥。根据产品样本或选刀光盘来选择正确的替代丝锥
	缺少冷却	先用较好的冷却液，以防止在丝锥切削刃上产生积屑瘤或是热应力。可参见本手册中有关冷却液的章节
	丝锥的切削速度太高	降低丝锥的切削速度，可以按照产品样本或选刀光盘的推荐来选择正确的丝锥切削速度。
产生积屑瘤	所用丝锥的型号有误	选用前角较小的丝锥，或是选用后角较大的丝锥。可根据产品样本或选刀光盘来选择正确的提到丝锥
	缺少冷却	选用较好的冷却液，以防止积屑瘤的产生。可参见本手册中有关冷却液的章节
	丝锥的表面处理不合适	可参见本手册中有关刀具表面处理的章节
	丝锥的切削速度太低	按照产品样本或选刀光盘的推荐来选择合适的切削速度

铣削

铣削的注意事项

铣削是对工件表面进行加工的方法。加工时铣刀以相对较高的速度作旋转运动，工件则以相对较低的速度作进给运动，采用渐进的方式从工件上切除预定的加工余量。
 铣削加工的特点是，每个铣刀齿都切除其分配到的那部分加工余量，并产生较小的零碎切屑。

铣刀的类型

下面是三个基本的铣削加工方法：(A) 圆周铣削, (B) 面铣刀 和 (C) 立铣刀。

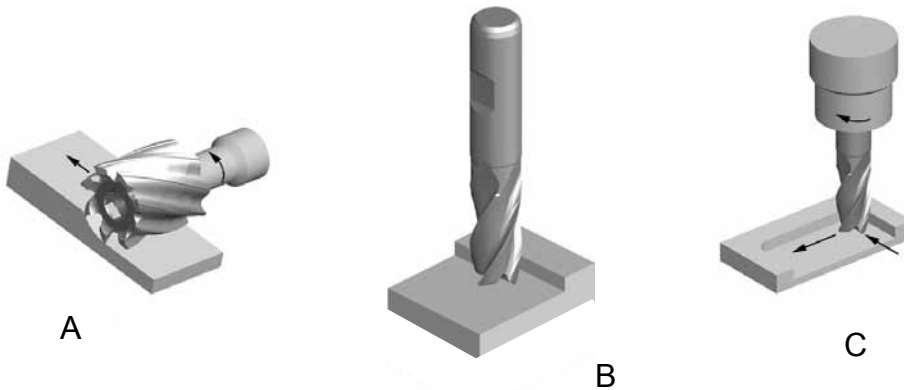

在作圆周铣削时（也称之为阔面铣削），铣刀的旋转轴线与被加工表面平行。在铣刀圆周上分布着一定数量的刀齿，每个刀齿都象是一个加工平面的单刃切削刀具。用作圆周铣削的铣刀可以是直齿的，也可以使螺旋齿的，它们可分别作正交的或斜交的切削运动。

在作面铣削时，铣刀安装在主轴上，该主轴的旋转轴线与被加工表面垂直。切削刃则位于铣刀的圆周上和端面上，对工件的表面进行铣削。

在作端铣削是，铣刀通常绕垂直于工件表面的轴线作旋转运动，但也可将铣刀倾斜，以加工出锥形表面。这种铣刀的刀齿位于铣刀端面上和刀体圆周上。

应用场合

金属切除率MRR和应用场合有很大关系。对于每种不同的应用场合，都有不同的金属切除率MRR。金属切除率随铣刀与工件的接触区域大小而变化。在最新出版的多马公司产品样本中，用简单的图标来表示不同的应用场合。

侧铣	面铣	槽铣	插入铣	斜向铣
径向切削深度应小于立铣刀直径的0.25倍。	径向切削应不大于立铣刀直径的0.9倍，轴向切深应小于立铣刀直径的0.1倍	加工凹槽或键槽，其径向切深等于立铣刀的直径。	若立铣刀带中心切削刃时，可用来对工件作钻削加工。在做这种插入式铣削时，应把铣刀的进给量减半。	立铣刀同时在轴向和径向切入工件

铣削的常见问题

问题	原因	纠正
断裂	铣削余量太大	减少每齿进给量
	进给速度太快	放慢进给速度
磨损	铣刀的槽长或总长太长了	把铣刀刀柄多夹进夹头一点，或采用较短的铣刀
	工件材料太硬	查看样本或选刀软件，以得到正确的切削参数
	切削速度和进给量不正确	查看样本或选刀软件，以得到正确的切削参数
	排屑不畅	重新定位冷却液管路
	采用逆铣法	改为顺铣法
	铣刀螺旋角不正确	参见样本/选刀软件中的推荐值，选择正确的替代刀具
崩刃	进给量太大	减少进给量
	振动	降低转速
	切削速度太低	提高转速
	采用逆铣法	改为顺铣法
	刀具刚度问题	选用更短的刀具，或把刀具柄部更深地插入刀具夹头
	工件刚度问题	把工件牢固地夹紧
刀具寿命短	难加工的工件材料	参见样本或选刀软件，以选择正确的替代刀具
	切削角度和主后角不正确	改为正确的切削角度
	铣刀和工件之间有摩擦	采用涂层刀具
表面光洁度太差	进给太快	放慢至正确的进给速度
	切削速度太慢	提高切削速度
	切屑拉伤	减少切削余量
	刀具磨损	更换或重磨工具
	刀刃上产生积屑瘤	换用螺旋角较大的刀具
	切屑粘结	加大冷却液流量

问题	原因	纠正
加工精度差	刀具偏斜	采用较短的刀具，或是把刀具柄部更深地插入刀具夹头
	铣刀的槽数太少	采用刀槽数更多的铣刀
	刀具夹头松动或磨损	修理或更换刀具夹头
	刀具夹头的刚度较差	换用更短的或刚度更好的刀具夹头
	主轴的刚度较差	采用较大的主轴
振动	进给量和切削速度太高	参见样本或选刀软件，对进给量和切削速度进行修正
	刀具的槽长或总长太长了	把刀具柄部多夹进刀具夹头一点，或采用较短的铣刀
	切削深度太大	减少切削深度
	刚度不足（机床和刀具夹头）	检查刀具夹头，必要时加以更换

Brasileiro		Dureza	Resistência à tração	ISO
Grupos de Materiais (AMG)		HB	N/mm ²	
1. Aço	1.1 Aço macio magnético	< 120	< 400	P 1
	1.2 Aço estrutural, Aço cementado	< 200	< 700	P 1
	1.3 Aço-carbono	< 250	< 850	P 2
	1.4 Aço de liga	< 250	< 850	P 3
	1.5 Aço de liga, Aço temperado	> 250 < 350	> 850 < 1200	P 4
	1.6 Aço de liga, Aço temperado	> 350	> 1200 < 1620	H 1
	1.7 Aço de liga temperado	49-55HRC	> 1620	H 3
	1.8 Aço de liga temperado	55-63HRC	> 1980	H 4
2. Aço inoxidável	2.1 Aço inoxidável de maquinagem fácil	< 250	< 850	M 1
	2.2 Austenítico	< 320	< 1100	M 3
	2.3 Ferrítico + Austenítico + Martensítico	< 300	< 1000	M 2
	2.4	> 320 < 410	> 1100 < 1400	S 2
3. Ferro fundido	3.1 Grafite lamelar	< 150	> 500	K 1
	3.2 Grafite lamelar	> 150 < 300	> 500 < 1000	K 2
	3.3 Grafite nodular/ Ferro fundido maleável	< 200	< 700	K 3
	3.4 Grafite nodular/ Ferro fundido maleável	> 200 < 300	> 700 < 1000	K 4
4. Titânio	4.1 Titânio, sem liga	< 200	< 700	S 1
	4.2 Titânio, com liga	< 270	< 900	S 2
	4.3 Titânio, com liga	> 270 < 350	> 900 ≤ 1250	S 3
	4.4	< 150	< 500	S 1
5. Níquel	5.1 Níquel, sem liga	< 270	> 900	S 2
	5.2 Níquel, com liga	> 270 < 350	> 900 < 1200	S 3
	5.3 Níquel, com liga	< 100	< 350	N 3
	5.4	< 200	< 700	N 4
6. Cobre	6.1 Cobre	< 200	< 700	N 3
	6.2 Latão beta, bronze	< 200	< 700	N 4
	6.3 Latão alfa	< 200	< 700	N 3
	6.4 Bronze de alta resistência	< 470	< 1500	N 4
7. Alumínio Magnésio	7.1 Al, Mg, sem liga	< 100	< 350	N 1
	7.2 Al com liga, Si < 0.5%	< 150	< 500	N 1
	7.3 Al com liga, Si > 0.5% < 10%	< 120	< 400	N 1
	7.4 Al com liga, Si > 10% reforçadas com monocristais fibrosos, ligas de Al/Mg	< 120	< 400	N 2
8. Materiais sintéticos	8.1 Termoplásticos	---	---	O
	8.2 Plásticos termoduros	---	---	O
	8.3 Materiais plásticos reforçados	---	---	O
9. Materiais duros	9.1 Cerametal (metalocerâmica)	< 550	< 1700	H
	10. Grafite	---	< 100	O



EXEMPLOS DE MATERIAIS DE PEÇAS A USINAR

AMG	EN	W.N.	DIN	BS	SS	USA	UNS	ISO
1.1		1.1015, 1.1013	Rf60, Rf100	230M67, 050A12	1160	Leaded Steels	G12120	P 1
1.2	EN 10 025 - S235JRG2	1.1012, 1.1053, 1.7131	S37-2, 16MnCr5, S160-2	060A35, 080M40, 4360-50B	1312, 1412, 1914	135, 30	G10100	P 1
1.3	EN 10 025 - E295	1.1191, 1.0601	CK45, C60	080M46, 080A62	1550, 2142, 2172	1024, 1060, 1061	G10600	P 2
1.4	EN 10 083-1 - 42CrMo4 - EN 10 270-2	1.7225, 1.3505, 1.6582, 1.3247	42CrMo4, 100Cr6, 34CrNiMo6, S2-10-1-8	708M4042, 817M40, 534A98, BM2, BT42	1672-04, 2090, 2244-02, 2541-02	4140, A2, 4340, M42, M2	G41270, G41470, T30102, T11342	P 3
1.5	EN ISO 4957 - H56-52 - EN ISO 4957 - H56-52-5	1.2510, 1.2713, 1.3247, 1.2080	100MnCrW12, 55NiCrMoV6, X210Cr12, S2-10-1-8	801, BM2, BT42, 828 M40, 830M31	2244-04, 2541-03, 2850, 2722, 2723	01, L6, M42, D3, A2, M2, 4140, 8630	G96300, T30102, T11302, T30403, T11342	P 4
1.6	EN ISO 4957 - H52-9-1-8	1.2510, 1.2713, 1.3247, 1.2080	100MnCrW12, X210Cr12, S2-10-1-8	801, 828 M40, 830M31	2244-05, 2541-05, HARDOX 400	01, L6, M42, D3, 4140, 8130	T30403, G41400, J14047	H 1
1.7	EN ISO 4957 - H52-9-1-8	1.2510	100MnCrW4	BO1, BD3, BH13	HARDOX 500			H 3
1.8	EN ISO 4957 - X40CrMoV5-1	1.3343, 1.2344	S6-5-2, GX40CrMoV5-1	BM2, BH13	2242 HARDOX 600			H 4
2.1	EN 10 088-3 - X14CrMoS17	1.4305, 1.4104	X10CrNiS189, X12CrMoS17	303 S21, 416 S37	2301, 2312, 2314, 2346, 2380	303, 416, 430F	S30300, S41600, S43020	M 1
2.2	EN 10 088-2-0 3 - 1.4301+AT	1.4301, 1.4541, 1.4571	X5CrNi189 X10CrNiMoTi1810	304 S15, 321 S17, 316 S, 320 S12	2310, 2333, 2337, 2343, 2353, 2377	304, 321, 316	S30400, S32100, S31600	M 3
2.3	EN 10 088-3 - 1.4460	1.4460, 1.4512, 1.4582	X8CrNiMo275, X4CrNiMoN6257	317 S16, 316 S16	2324, 2387, 2570	409, 430, 436	S40900, S4300, S43600	M 2
2.4	EN 1.4547	1.4547	X2CrNiMo20-18-6	HR41	2378	17-4PH	S31254	S 2
3.1	EN 1561 - EN-JL1030	0.6010, 0.6040	GG10, GG40	Grade150, Grade 400	0120, 0212, 0814	ASTM A48 class 20	F11401, F12801	K 1
3.2	EN 1561 - EN-JL1050	0.6025, 0.6040	GG25, GG40	Grade200, Grade 400	0125, 0130, 0140, 0217	ASTM A48 class 40, STM A48 class 60	F12801, F14101	K 2
3.3	EN 1561 - EN-JL2040	0.7040, 0.7070, 0.8145, 0.8045	GG40, GGG70, GTS45-06, GTW45-07	GG40, GGG70, GTS45-06, GTW45-07	0219, 0717, 0727, 0732, 0852	ASTM A220 grade 40010, ASTM A602 grade M4504	F22830, F20001	K 3
3.4	EN 1561 - EN-JL2050	0.7040, 0.7070, 0.8145, 0.8045	GG40, GGG70, GTS45-06, GTW45-07	GG40, GGG70, GTS45-06, GTW45-07	0221, 0223, 0737, 0854	ASTM A220 grade 90001, ASTM A602 grade M8501	F26230, 20005	K 4
4.1		3.7024LN	T199 8	TA1 to 9	T199 8	ASTM B265 grade 1	R50250	S 1
4.2		3.7164LN, 3.7119LN	TA16V4, TA165n2	TA10 to 14, TA17	TA16V4, TA165Sn2	AMS4928	R54790	S 2
4.3		3.7164LN, 3.7174LN, 3.7184LN	TA16V4, TA16V5Sn2, TA14MoSn2	TA10 to 13, TA28	TA16V5Sn2	AMS4928, AMS4971	R56400, R54790	S 3
5.1		2.4060, 2.4066	Nickel200, 270, N169 6	NA 11, NA12	N200, N4270	Nickel 200, Nickel 230	N02200, N02230	S 1
5.2		2.4630LN, 2.4602, 2.4650LN	Nimonic 75, Monel 400, Hastelloy C, Inconel 600	HR203, 3027-76		Nimonic 75, Monel 400, Hastelloy, Inconel 600	N06075, N10002, N04400, N06600	S 2
5.3		2.4668LN, 2.4631LN, 2.6554LN	Inconel 718, Nimonic 80A, Waspaloy	HR8, HR401, 601		Inconel 718, 625, Nimonic 80	N07718, N07080, N06625	S 3
6.1	EN 1652 - CW004A	2.0060, 2.0070	E-Cu57, SE-Cu	C101	5010	101	C10100, C1020	N 3
6.2	EN 1652 - CW612N	2.0380, 2.0360, 2.1030, 2.1080	CuZn39Pb2, CuZn40, CuSn8, CuSn6Zn	CZ120, CZ109, PB104	5168		C28000, C37710	N 4
6.3	EN 1652 - CW608L	2.0321, 2.0260	CuZn37, CuZn28	CZ108, CZ106	5150		C2600, C27200	N 3
6.4			Ampcoo 18, Ampco 25	AB1 type	5238, JM7-20			N 4
7.1	EN 485-2 - EN AW-1070A	3.0255	A189 5	LMO, 1 B (1050A)	4005	EC, 1060, 1100	A91060, A91100	N 1
7.2	EN 7552 - EN AW-5005	3.1355, 3.3525	AlCuMg2, AlMg2Mn0.8	LM5, 10, 12, N4 (5251)	4106, 4212	380, 520.0, 520.2, 2024, 6061	A03800, A05200, A92024	N 1
7.3	EN 1706 - EN AC-42000	3.2162.05, 3.2341.01	GD-AlSi8Cu, G-AlSi5Mg	LM2, 4, 16, 18, 21, 22, 24, 25, 26, 27, L-109	4244	319.0, 333.0, 319.1, 356.0	A03190, A03330, C35600	N 1
7.4	SS-EN 1706 - EN AC-47000	3.2581.01	G-AS18, G-AS12	LM6, 12, 13, 20, 28, 29, 30	4260, 4261, 4262	4032, 222.1, A332.0	A94032, A02220, A13320	N 2
8.1			Polystyrene, Nylon, PVC Cellulose, Acetate & Nitrate			Polystyrene, Nylon, PVC		O
8.2			Ebonite, Tufnol, Bakelite			Bakelite		O
8.3			Kevlar, Pinned Circuit boards			Kevlar		O
9.1			Ferroc, Ferroitanit					H
10.1			Graphite					O

Tabela de Velocidade de Corte



		Vc															
m/Min		5	8	10	15	20	25	30	40	50	60	70	80	90	100	110	150
Feet/Min		16	26	32	50	66	82	98	130	165	197	230	262	296	330	362	495
Ø		RPM															
mm	inch																
1,00		1592	2546	3183	4775	6366	7958	9549	12732	15916	19099	22282	25465	28648	31831	35014	47747
1,50		1061	1698	2122	3183	4244	5305	6366	8488	10610	12732	14854	16977	19099	21221	23343	31831
2,00		796	1273	1592	2387	3183	3979	4775	6366	7958	9549	11141	12732	14324	15916	17507	23873
2,50		637	1019	1273	1910	2546	3183	3820	5093	6366	7639	8913	10186	11459	12732	14006	19099
3,00		531	849	1061	1592	2122	2653	3183	4244	5305	6366	7427	8488	9549	10610	11671	15916
3,18	1/8	500	801	1001	1501	2002	2502	3003	4004	5005	6006	7007	8008	9009	10010	11011	15015
3,50		455	728	909	1364	1819	2274	2728	3638	4547	5457	6366	7276	8185	9095	10004	13642
4,00		398	637	796	1194	1592	1989	2387	3183	3979	4775	5570	6366	7162	7958	8754	11937
4,50		354	566	707	1061	1415	1768	2122	2829	3537	4244	4951	5659	6366	7074	7781	10610
4,76	3/16	334	535	669	1003	1337	1672	2006	2675	3344	4012	4681	5350	6018	6687	7356	10031
5,00		318	509	637	955	1273	1592	1910	2546	3183	3820	4456	5093	5730	6366	7003	9549
6,00		265	424	531	796	1061	1326	1592	2122	2653	3183	3714	4244	4775	5305	5836	7958
6,35	1/4	251	401	501	752	1003	1253	1504	2005	2506	3008	3509	4010	4511	5013	5514	7519
7,00		227	364	455	682	909	1137	1364	1819	2274	2728	3183	3638	4093	4547	5002	6821
7,94	5/16	200	321	401	601	802	1002	1203	1604	2004	2405	2806	3207	3608	4009	4410	6013
8,00		199	318	398	597	796	995	1194	1592	1989	2387	2785	3183	3581	3979	4377	5968
9,00		177	283	354	531	707	884	1061	1415	1768	2122	2476	2829	3183	3537	3890	5305
9,53	3/8	167	267	334	501	668	835	1002	1336	1670	2004	2338	2672	3006	3340	3674	5010
10,00		159	255	318	477	637	796	955	1273	1592	1910	2228	2546	2865	3183	3501	4775
11,11	7/16	143	229	287	430	573	716	860	1146	1433	1719	2006	2292	2579	2865	3152	4298
12,00		133	212	265	398	531	663	796	1061	1326	1592	1857	2122	2387	2653	2918	3979
12,70	1/2	125	201	251	376	501	627	752	1003	1253	1504	1754	2005	2256	2506	2757	3760
14,00		114	182	227	341	455	568	682	909	1137	1364	1592	1819	2046	2274	2501	3410
14,29	9/16	111	178	223	334	446	557	668	891	1114	1337	1559	1782	2005	2228	2450	3341
15,00		106	170	212	318	424	531	637	849	1061	1273	1485	1698	1910	2122	2334	3183
15,88	5/8	100	160	200	301	401	501	601	802	1002	1203	1403	1604	1804	2004	2205	3007
16,00		99	159	199	298	398	497	597	796	995	1194	1393	1592	1790	1989	2188	2984
17,46	11/16	91	146	182	273	365	456	547	729	912	1094	1276	1458	1641	1823	2005	2735
18,00		88	141	177	265	354	442	531	707	884	1061	1238	1415	1592	1768	1945	2653
19,05	3/4	84	134	167	251	334	418	501	668	835	1003	1170	1337	1504	1671	1838	2506
20,00		80	127	159	239	318	398	477	637	796	955	1114	1273	1432	1592	1751	2387
24,00		66	106	133	199	265	332	398	531	663	796	928	1061	1194	1326	1459	1989
25,00		64	102	127	191	255	318	382	509	637	764	891	1019	1146	1273	1401	1910
27,00		59	94	118	177	236	295	354	472	589	707	825	943	1061	1179	1297	1768
30,00		53	85	106	159	212	265	318	424	531	637	743	849	955	1061	1167	1592
32,00		50	80	99	149	199	249	298	398	497	597	696	796	895	995	1094	1492
36,00		44	71	88	133	177	221	265	354	442	531	619	707	796	884	973	1326
40,00		40	64	80	119	159	199	239	318	398	477	557	637	716	796	875	1194
50,00		32	51	64	95	127	159	191	255	318	382	446	509	573	637	700	955

HV Vickers	HRC Rockwell	HB Brinell	N/ mm ²	Tons/ sq. in.
940	68			
900	67			
864	66			
829	65			
800	64			
773	63			
745	62			
720	61			
698	60			
675	59			
655	58		2200	142
650		618	2180	141
640		608	2145	139
639	57	607	2140	138
630		599	2105	136
620		589	2070	134
615	56	584	2050	133
610		580	2030	131
600		570	1995	129
596	55	567	1980	128
590		561	1955	126
580		551	1920	124
578	54	549	1910	124
570		542	1880	122
560	53	532	1845	119
550		523	1810	117
544	52	517	1790	116
540		513	1775	115
530		504	1740	113
527	51	501	1730	112
520		494	1700	110
514	50	488	1680	109
510		485	1665	108
500		475	1630	105
497	49	472	1620	105
490		466	1595	103
484	48	460	1570	102
480		456	1555	101
473	47	449	1530	99
470		447	1520	98
460		437	1485	96
458	46	435	1480	96
450		428	1455	94
446	45	424	1440	93
440		418	1420	92

HV Vickers	HRC Rockwell	HB Brinell	N/ mm ²	Tons/ sq. in.
434	44	413	1400	91
423	43	402	1360	88
413	42	393	1330	86
403	41	383	1300	84
392	40	372	1260	82
382	39	363	1230	80
373	38	354	1200	78
364	37	346	1170	76
355	36	337	1140	74
350		333	1125	73
345	35	328	1110	72
340		323	1095	71
336	34	319	1080	70
330		314	1060	69
327	33	311	1050	68
320		304	1030	67
317	32	301	1020	66
310	31	295	995	64
302	30	287	970	63
300		285	965	62
295		280	950	61
293	29	278	940	61
290		276	930	60
287	28	273	920	60
285		271	915	59
280	27	266	900	58
275		261	880	57
272	26	258	870	56
270		257	865	56
268	25	255	860	56
265		252	850	55
260	24	247	835	54
255	23	242	820	53
250	22	238	800	52
245		233	785	51
243	21	231	780	50
240		228	770	50
235		223	755	49
230		219	740	48
225		214	720	47
220		209	705	46
215		204	690	45
210		199	675	44
205		195	660	43
200		190	640	41

TOLERÂNCIA



Tol	Ø mm							
	> 1 ≤ 3	> 3 ≤ 6	> 6 ≤ 10	> 10 ≤ 18	> 18 ≤ 30	> 30 ≤ 50	> 50 ≤ 80	> 80 ≤ 120
	µm							
e8	-14 / -28	-20 / -38	-25 / -47	-32 / -59	-40 / -73	-50 / -89	-60 / -106	-72 / -126
f6	-6 / -12	-10 / -18	-13 / -22	-16 / -27	-20 / -33	-25 / -41	-30 / -49	-36 / -58
f7	-6 / -16	-10 / -22	-13 / -28	-16 / -34	-20 / -41	-25 / -50	-30 / -60	-36 / -71
h6	0 / -6	0 / -8	0 / -9	0 / -11	0 / -13	0 / -16	0 / -19	0 / -22
h7	0 / -10	0 / -12	0 / -15	0 / -18	0 / -21	0 / -25	0 / -30	0 / -35
h8	0 / -14	0 / -18	0 / -22	0 / -27	0 / -33	0 / -39	0 / -46	0 / -54
h9	0 / -25	0 / -30	0 / -36	0 / -43	0 / -52	0 / -62	0 / -74	0 / -87
h10	0 / -40	0 / -48	0 / -58	0 / -70	0 / -84	0 / -100	0 / -120	0 / -140
h11	0 / -60	0 / -75	0 / -90	0 / -110	0 / -130	0 / -160	0 / -190	0 / -220
h12	0 / -100	0 / -120	0 / -150	0 / -180	0 / -210	0 / -250	0 / -300	0 / -350
k10	+40 / 0	+48 / 0	+58 / 0	+70 / 0	+84 / 0	+100 / 0	+120 / 0	+140 / 0
k12	+100 / 0	+120 / 0	+150 / 0	+180 / 0	+210 / 0	+250 / 0	+300 / 0	+350 / 0
m7	+2 / +12	+4 / +16	+6 / +21	+7 / +25	+8 / +29	+9 / +34	+11 / +41	+13 / +48
js14	+/- 125	+/- 150	+/- 180	+/- 215	+/- 260	+/- 310	+/- 370	+/- 435
js16	+/- 300	+/- 375	+/- 450	+/- 550	+/- 650	+/- 800	+/- 950	+/- 1100
H7	+10 / 0	+12 / 0	+15 / 0	+18 / 0	+21 / 0	+25 / 0	+30 / 0	+35 / 0
H8	+14 / 0	+18 / 0	+22 / 0	+27 / 0	+33 / 0	+39 / 0	+46 / 0	+54 / 0
H9	+25 / 0	+30 / 0	+36 / 0	+43 / 0	+52 / 0	+62 / 0	+74 / 0	+87 / 0
H12	+100 / 0	+120 / 0	+150 / 0	+180 / 0	+210 / 0	+250 / 0	+300 / 0	+350 / 0
P9	-6 / -31	-12 / -42	-15 / -51	-18 / -61	-22 / -74	-26 / -86	-32 / -106	-37 / -124

1µm = 0.001mm

FURAÇÃO

DICAS GERAIS PARA FURAÇÃO

1. Selecione a broca mais adequada para a aplicação, considerando o material a ser usinado, a capacidade da máquina ferramenta e o fluido refrigerante a ser usado.
2. A flexibilidade entre a peça e o fuso da máquina pode provocar danos na broca, na peça e na máquina – garanta sempre a estabilidade máxima. Isto pode ser melhorado selecionando a broca mais curta possível para a aplicação.
3. A fixação da ferramenta é um fator importante na operação de furação e não se deve permitir o escorregamento ou o movimento da broca no mandril.
4. Recomenda-se o uso de fluidos refrigerantes e lubrificantes adequados conforme exigido pela operação de furação específica. Quando utilizar fluidos e lubrificantes, assegure um abastecimento farto, especialmente na ponta da broca.
5. É essencial a evacuação dos cavacos durante a furação para garantir o procedimento correto de furação. Jamais permita que os cavacos permaneçam estacionários nos canais.
6. Ao reafiar uma broca, verifique sempre que seja produzida a correta geometria da ponta e que qualquer desgaste tenha sido removido.

DIMENSÃO DO FURO

Na medida em que as configurações geométricas de substrato e de cobertura avançam, aumenta-se a capacidade da broca para produzir dimensões de furos mais exatas. Em geral, uma ferramenta com geometria standard produzirá um furo com tolerância H12. Porém, conforme a configuração da broca torna-se mais complexa, a dimensão atingível, sob condições favoráveis, poderá ser com uma tolerância tão boa como a H8. Para uma melhor visualização, seguem abaixo os tipos de produto e as tolerâncias atingíveis na furação:

- Brocas HSS para utilização geral – H12
- Brocas HSS / HSS-E de canais parabólicos para furos profundos – H10
- De Metal Duro de Alto Desempenho com cobertura - H8/H9

ESTRATÉGIA PARA FURAÇÃO PROFUNDA

Para furação profunda, têm sido adotados diversos métodos para atingir a profundidade exigida. O exemplo abaixo mostra quatro modos de executar um furo com 10 x o diâmetro da broca.

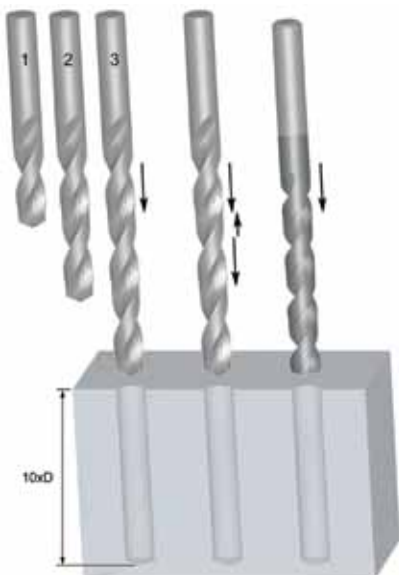

	Furação em Série	Furação em Série
No. de brocas	3 (2,5xD, 6xD, 10xD)	2 (2,5xD, 10xD)
Tipo de broca	Geometria Standard, uso geral	Geometria Standard, uso geral
+ / -	Cara Consome muito tempo	Maior custo-benefício Rápido

	Furação Intermitente	Furação num só Passo
No. de brocas	1 (10xD)	1 (10xD)
Tipo de broca	Geometria Standard, uso geral	Ferramentas para usos específicos
+ / -	Consome muito tempo	Custo-benefício Rápido

SOLUÇÃO DE PROBLEMAS NA FURAÇÃO

PROBLEMA	CAUSA	SOLUÇÃO
Lingüeta de extração quebrada ou dobrada	Encaixe ruim entre a haste e o soquete	Verificar que a haste e o soquete estejam limpas e livres de danos
Trinca no núcleo	Avanço exagerado	Reduzir o avanço para a taxa ideal
	Folga inicial insuficiente	Reafiar para especificação correta
	Adelgaçamento excessivo do núcleo	Reafiar para especificação correta
	Impacto excessivo na ponta da broca	Evitar impactos na ponta da broca. Cuidado com as brocas de haste cônica durante a inserção/ ejeção no fuso
Guias externas gastas	Velocidade excessiva	Reduzir velocidade ao ideal – poderá ser possível aumentar o avanço
Guias externas quebradas	Montagem instável da peça	Reduzir movimento na peça
Aresta de corte lascada	Folga inicial excessiva	Reafiar para especificação correta
Quebra na descarga do canal	Canais engasgados	Adotar um conceito de furação intermitente/ em série
	Escorregamento da broca	Verifique que a broca esteja presa firmemente no mandril e no fuso
Furo com acabamento em espiral	Avanço insuficiente	Aumentar avanço
	Precisão deficiente da posição	Utilizar uma broca guia antes da furação
Dimensão do furo grande demais	Geometria da ponta incorreta	Verificar a geometria da ponta
	Liberção ineficiente dos cavacos	Ajustar velocidade, avanço e comprimento do curso para obter um cavaco melhor administrado

ALARGADORES

DICAS GERAIS PARA O USO DE ALARGADORES

Para se obter os melhores resultados na utilização de alargadores é essencial fazer com que “funcionem”. É uma falha comum a de preparar furos para alargamento com pouco material de sobra. Se no furo for deixado material insuficiente antes do alargamento, o alargador irá derrapar, apresentando desgaste rapidamente e isso resultará numa perda de diâmetro. É igualmente importante para o serviço não deixar excesso de material no furo. (Ver Remoção de Material abaixo).

1. Selecione o tipo ideal de alargador e as velocidades e avanços ideais para a aplicação. Certifique-se de que os furos previamente feitos tenham o diâmetro correto.
2. A peça de trabalho deve ser montada rigidamente e o fuso da máquina não deverá ter jogo.
3. O mandril que suporta um alargador com haste paralela deverá ser de boa qualidade. Se o alargador escorregar no mandril e o avanço for automático, poderá ocorrer a quebra do alargador.
4. Mantenha a projeção da ferramenta com relação ao fuso da máquina num mínimo.
5. Utilizar lubrificantes recomendados para melhorar a vida útil do alargador e para garantir que o fluido chegue até as arestas de corte. Como o alargamento não é uma operação de corte pesada, uma solução de óleo em proporção de 40:1 é satisfatória normalmente. No caso de ferro fundido cinzento, poderá ser utilizado jato de ar, se a usinagem for a seco.
6. Não permita que os canais de um alargador fiquem bloqueados com cavacos.
7. Antes de reafiar o alargador, verificar a concentricidade entre pontas. Na maioria dos casos será necessário afiar somente os chanfros de entrada.
8. Mantenha afiados os alargadores. A reafiação frequente é uma boa economia, porém é importante compreender que os alargadores cortam somente nos chanfros de entrada e cônicos e não nos campos. Em consequência, somente estes chanfros de guia necessitam reafiação. A precisão da reafiação é importante para a qualidade dos furos e a vida útil da ferramenta.

REMOÇÃO DE MATERIAL

A remoção recomendada de material no alargamento depende do material da aplicação e do acabamento da superfície do furo previamente executado. As linhas gerais para remoção de material são mostradas nas tabelas que seguem:

Dimensão do furo alargado (mm)	Quando há pré-furo	Quando há pré-furo no centro	Dimensão do furo alargado (polegadas)	Quando há pré-furo	Quando há pré-furo no centro
Abaixo de 4	0.1	0.1	Abaixo de 3/16	0.004	0.004
Acima de 4 a 11	0.2	0.15	3/16 to 1/2	0.008	0.006
Acima de 11 a 39	0.3	0.2	1/2 to 1.1/2	0.010	0.008
Acima de 39 a 50	0.4	0.3	1.1/2 to 2	0.016	0.010

LIMITES DE TOLERÂNCIA



1. OS DIÂMETROS DE CORTE DOS ALARGADORES STANDARD

O diâmetro (d_1) é medido através do campo circular imediatamente atrás da guia cônica. A tolerância é conforme DIN 1420 e deve produzir furos H7.

TOLERÂNCIAS DOS ALARGADORES			
Diâmetro (mm)		Limites de Tolerância (mm)	
Acima de	Até e incluindo	Alto +	Baixo +
	3	0.008	0.004
3	6	0.010	0.005
6	10	0.012	0.006
10	18	0.015	0.008

TOLERÂNCIAS DOS ALARGADORES			
Diâmetro (mm)		Limites de Tolerância (mm)	
Acima de	Até e incluindo	Alto +	Baixo +
18	30	0.017	0.009
30	50	0.021	0.012
50	80	0.025	0.014

2. OS FUROS H7

A tolerância mais frequente num furo acabado é H7 (ver tabela abaixo). Para quaisquer outras tolerâncias a figura e tabela abaixo do item 3 podem ser utilizadas para calcular a localização e largura da tolerância dos alargadores.

TOLERÂNCIAS DOS FUROS			
Diâmetro (mm)		Limites de Tolerância (mm)	
Acima de	Até e incluindo	Alto +	Baixo +
	3	0.010	0
3	6	0.012	0
6	10	0.015	0
10	18	0.018	0

TOLERÂNCIAS DOS FUROS			
Diâmetro (mm)		Limites de Tolerância (mm)	
Acima de	Até e incluindo	Alto +	Baixo +
18	30	0.021	0
30	50	0.025	0
50	80	0.030	0

3. Quando for necessário definir as dimensões de um alargador especial destinado a cortar para uma tolerância específica, ex. D8, pode ser utilizado este guia:

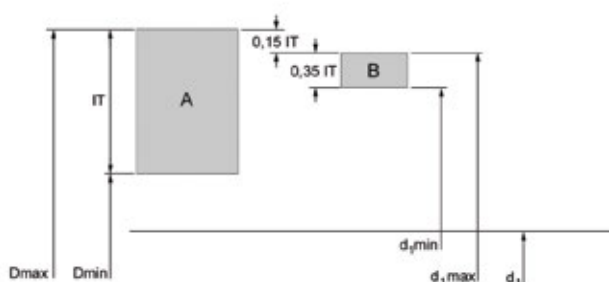

A = Tolerâncias dos Furos
 B = Tolerâncias dos Alargadores
 IT = Tolerância do furo
 Dmax = Diâmetro Máx do Furo
 Dmin = Diâmetro Mín do Furo
 d_1 = Diâmetro Nominal
 $d_{1,max}$ = Diâmetro Máx do Alargador
 $d_{1,min}$ = Diâmetro Mín do Alargador

Dimensão da Tolerância (μ)	Dimensão da Tolerância no Diâmetro (mm)							
	de 1 a 3	acima de 3 até 6	acima de 6 até 10	acima de 10 até 18	acima de 18 até 30	acima de 30 até 50	acima de 50 até 80	acima de 80 até 120
IT5	4	5	6	8	9	11	13	15
IT6	6	8	9	11	13	16	19	22
IT7	10	12	15	18	21	25	30	35
IT8	14	18	22	27	33	39	46	54
IT9	25	30	36	43	52	62	74	87
IT10	40	48	58	70	84	100	120	140
IT11	60	75	90	110	130	160	190	220
IT12	100	120	150	180	210	250	300	350

ex. furo de 10mm com tolerância D8, Max diâmetro = 10,062, Min diâmetro = 10,040, Tolerância do furo (IT8) = 0,022

Limite máximo: $0,15 \times$ tolerância do furo (IT8) = 0,0033, arredondado = 0,004

Limite mínimo: $0,35 \times$ tolerância do furo (IT8) = 0,0077, arredondado = 0,008

Limite máximo para alargador = $10,062 - 0,004 = 10,058$

Limite mínimo para alargador = $10,058 - 0,008 = 10,050$

SOLUÇÃO DE PROBLEMAS NO ALARGAMENTO

PROBLEMA	CAUSA	SOLUÇÃO
Lingüetas de extração quebradas ou deformadas	Ajuste incorreto entre haste e bucha	Verificar que a haste e a bucha estejam limpas e sem danos
Desgaste Rápido da Ferramenta	Material insuficiente a ser removido	Aumentar a quantidade de material a ser removido
Furo além da medida	Variação de altura das arestas de corte	Reafiar conforme especificação correta
	Deslocamento no fuso da máquina	Consertar e retificar deslocamento do fuso
	Defeitos no porta-ferramenta	Substituir o porta-ferramenta
	Haste da ferramenta danificada	Substituir ou retificar a ferramenta
	Ângulo da aresta guia assimétrico	Substitua ou rafie a ferramenta
	Ângulo da aresta guia assimétrico	Reafiar conforme especificação correta
	Avanço ou velocidade de corte elevados demais	Ajustar as condições de corte conforme o Catálogo
Furo menor que a medida	Material insuficiente a ser removido	Aumentar a quantidade de material a ser removido
	Excesso de calor gerado no alargamento. O furo dilata-se e se contrai	Aumentar o fluxo do fluido refrigerante
	O diâmetro da ferramenta está desgastado e abaixo da dimensão	Reafiar conforme especificação correta
	Avanço ou velocidade de corte baixos demais	Ajustar as condições de corte conforme o Catálogo
	Pré-furo é pequeno demais	Diminuir a quantidade de material a ser removido
Furos ovais e cônicos	Deslocamento no fuso da máquina	Consertar e retificar deslocamento do fuso
	Desalinhamento entre ferramenta e furo	Usar um alargador “ponte”
	Ângulo da aresta guia assimétrico	Reafiar conforme especificação correta
Acabamento ruim do furo	Material excessivo a ser removido	Diminuir a quantidade de material a ser removido
	Ferramenta gasta	Reafiar conforme especificação correta
	Ângulo de corte pequeno demais	Reafiar conforme especificação correta
	Emulsão ou óleo de corte diluídos demais	Aumentar % de concentração
	Avanço e /ou velocidade baixos demais	Ajustar as condições de corte conforme o Catálogo
	Velocidade de corte alta demais	Ajustar as condições de corte conforme o Catálogo
A ferramenta se prende e quebra	Ferramenta gasta	Reafiar conforme especificação correta
	Conicidade traseira da ferramenta é pequena demais	Verificar e substituir/modificar a ferramenta
	A largura da guia é exagerada	Verificar e substituir/modificar a ferramenta
	O material da peça de trabalho tende a prender	Utilizar um alargador regulável para compensar o deslocamento
	Pré-furo é pequeno demais	Diminuir a quantidade de material a ser removido
	Material heterogêneo com inclusões duras	Utilizar alargador de metal duro

ROSQUEAMENTO

DICAS GERAIS SOBRE ROSQUEAMENTO

O sucesso de qualquer operação de rosqueamento depende de diversos fatores, todos afetam a qualidade do produto acabado.

1. Selecione a geometria correta do macho para o material da peça e e o tipo do furo, por exemplo, passante ou cego, através da tabela de Classificação de Materiais.
2. Verifique que o componente esteja firmemente fixado – o movimento lateral poderá causar a quebra do macho ou roscas de baixa qualidade.
3. Selecione a dimensão correta da broca conforme a página correspondente do catálogo. Cuide sempre para que seja mantido no mínimo o endurecimento superficial da peça.
4. Selecione a velocidade de corte correta conforme mostrada no catálogo.
5. Utilize o fluido de corte adequado para uma correta aplicação.
6. Nas aplicações NC (Controle Numérico) verifique se o valor do avanço escolhido para o programa está correto. Quando for utilizado um dispositivo para rosquear, recomenda-se de 95% a 97% do passo para permitir que o macho produza seu próprio passo.
7. Quando possível, fixe o macho num dispositivo de rosqueamento de boa qualidade com limitação do torque, que assegure o movimento axial livre do macho e que o apresente corretamente com relação ao furo. Isto também protegerá o macho de uma quebra se atingir acidentalmente o fundo de um furo cego.
8. Controle a entrada suave do macho no furo, pois um avanço desigual poderá causar um alargamento da rosca.

TABELA DE TOLERÂNCIAS DE MACHOS VS TOLERÂNCIAS DE ROSCAS INTERNAS (PORCAS)

Classe de Tolerância, macho			Tolerância de Rosca Interna (porca)					Aplicação
ISO	DIN	ANSI BS	4 H	5 H	6 H	7 H	8 H	
ISO 1	4 H	3 B	4 H	5 H				Ajuste sem folga
ISO 2	6 H	2 B	4 G	5 G	6 H			Ajuste Normal
ISO 3	6 G	1 B			6 G	7 H	8 H	Ajuste com folga grande
-	7 G	-				7 G	8 G	Ajuste solto para tratamento ou revestimento a seguir

SOLUÇÃO DE PROBLEMAS NO ROSQUEAMENTO

PROBLEMA	CAUSA	SOLUÇÃO
Super-Dimensão	Tolerância Incorreta	Escolher um macho com tolerância de rosca mais baixa.
	Taxa de avanço axial incorreta	Reduzir a taxa de avanço em 5-10% ou aumentar a pressão no porta-macho.
	Tipo errado de macho para a aplicação	Utilizar ponta helicoidal para furo passante ou canal helicoidal para furo cego. Utilizar ferramenta revestida para evitar as arestas postiças. Verificar Catálogo ou Selector para alternativa correta de ferramenta.
	Macho não centralizado no furo	Verificar o porta-macho e posicionar o centro do macho no furo.
	Falta de lubrificação	Utilizar uma boa lubrificação a fim de evitar a formação de aresta postiça. Ver Seção de Lubrificantes no manual técnico Dormer
	Velocidade do macho baixa demais	Seguir as recomendações no Catálogo / Selector.
Infra-Dimensão	Tipo errado de macho para a aplicação	Utilizar ponta helicoidal para furo passante ou canal helicoidal para furo cego. Utilizar ferramenta com cobertura para evitar as arestas postiças. Utilizar macho com ângulo de incidência maior. Verificar Catálogo ou Selector para alternativa correta de ferramenta.
	Tolerância incorreta	Escolher um macho com tolerância mais elevada, especialmente em materiais com baixa tendência a super-dimensão, tais como ferro fundido, aço inoxidável.
	Lubrificante incorreto ou falta do mesmo	Utilizar uma boa lubrificação a fim de evitar o bloqueio dos cavacos dentro do furo. Ver Seção de Lubrificantes no manual técnico Dormer
	Furo pequeno demais para o macho	Aumentar o diâmetro da broca para o valor máximo. Verifique a medida da broca para o rosqueamento
	O material "fecha-se" após o rosqueamento	Ver recomendações no Catálogo / Selector para alternativa correta de ferramenta.
Escamação	Tipo errado de macho para a aplicação	Escolher um macho com menor ângulo de incidência. Escolher um macho com chanfro mais longo. Utilizar machos com ponta helicoidal para furo passante e canais helicoidal para furos cegos, a fim de evitar bloqueio dos cavacos. Verificar Catálogo ou Selector para alternativa correta de ferramenta.
	Lubrificação incorreta ou falta da mesma	Utilizar boa lubrificação a fim de evitar aresta postiça. Ver Seção Lubrificantes no manual técnico Dormer
	Os machos batem no fundo do furo	Aumentar profundidade de furação ou diminuir profundidade de rosqueamento.
	Superfície endurecida pelo trabalho	Reduzir velocidade, utilizar ferramenta com cobertura, utilizar boa lubrificação. Ver Seção para usinagem de aços inoxidáveis no manual técnico Dormer
	Cavacos presos na reversão	Evitar retorno repentino do macho no movimento de reversão.
	O chanfro bate na entrada do furo	Verificar posição axial e reduzir o erro axial da ponta do macho no centro do furo.
	Furo pequeno demais para o macho	Aumentar o diâmetro da broca até o valor máximo. Verifique a medida da broca para o rosqueamento

SOLUÇÃO DE PROBLEMAS NO ROSQUEAMENTO

PROBLEMA	CAUSA	SOLUÇÃO
Quebra do macho	Macho desgastado	Usar um macho novo ou reafiar o que está usando.
	Falta de lubrificante	Utilizar uma boa lubrificação a fim de evitar aresta postiça e bloqueio de cavacos. Ver Seção Lubrificação no manual técnico Dormer
	O macho bate no fundo do furo	Aumentar a profundidade da furação ou diminuir a profundidade do rosqueamento.
	Velocidade do macho muito elevada	Reduzir a velocidade do macho. Seguir as recomendações de Catálogo/Selector.
	Superfície endurecida pelo trabalho	Reduzir velocidade. Utilizar ferramenta revestida. Utilizar boa lubrificação. Ver Seção para Usinagem de Aços Inoxidáveis no manual técnico Dormer
	Furo a ser rosqueado pequeno demais	Aumentar o diâmetro da broca até o valor máximo. Ver Tabelas de Brocas para Rosqueamento.
	Torque elevado demais	Utilizar dispositivo de rosqueamento com embreagem de reajuste do torque.
	O material se contrai após o rosqueamento	Ver recomendações no Catálogo/ Selector de Produto para a alternativa correta da ferramenta.
Desgaste rápido	Tipo errado de macho para a aplicação	Utilizar macho com menor ângulo de incidência e maior alívio. Verificar Catálogo ou Selector para alternativa correta da ferramenta.
	Falta de lubrificante	Utilizar uma boa lubrificação a fim de evitar aresta postiça. Ver Seção Lubrificação no manual técnico Dormer
	Velocidade do macho alta demais	Reduzir velocidade de corte. Seguir recomendações no Catálogo/Selector.
Aresta postiça	Tipo errado de macho para a aplicação	Utilizar macho com menor ângulo de incidência e maior alívio. Verificar Catálogo ou Selector para alternativa correta da ferramenta.
	Falta de lubrificante	Utilizar uma boa lubrificação a fim de evitar aresta postiça. Ver Seção Lubrificação no manual técnico Dormer
	Tratamento da superfície não é adequado	Escolha o macho com o tratamento superficial recomendado para a aplicação
	Velocidade do macho baixa demais	Seguir recomendações do Catálogo/ Selector.

FRESAMENTO

DICAS GERAIS PARA FRESAMENTO

O fresamento é um processo de gerar superfícies usinadas pela remoção progressiva de uma quantidade pré-determinada de material da peça de trabalho a uma taxa de movimento ou avanço relativamente baixa mediante uma fresa que gira a uma velocidade comparativamente alta.

A característica principal do processo de fresamento é que cada aresta de corte da fresa remove a sua parcela do material na forma de cavacos individuais pequenos.

TIPOS DE FRESAS

As três operações básicas de fresamento são mostradas abaixo: (A) fresamento periférico, (B) fresamento facial e (C) fresamento de topo.

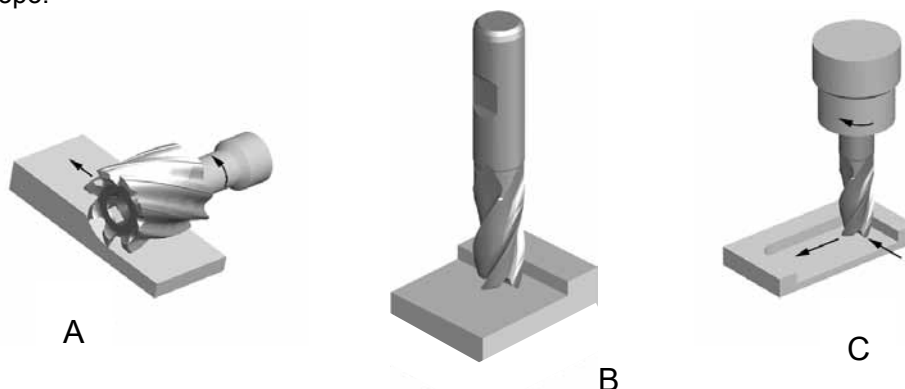

No fresamento periférico (também denominado fresamento de blocos), o eixo de rotação da fresa está paralelo à superfície da peça de trabalho a ser usinada. A fresa tem um número de facas na sua circunferência, cada uma atuando como uma ferramenta de corte individual para fresamento plano. As fresas utilizadas em fresamento periférico podem ter facas retas ou helicoidais gerando uma ação de corte ortogonal ou oblíqua.

No fresamento facial, a fresa está montada num fuso com uma rotação do eixo perpendicular à superfície da peça de trabalho. A superfície fresada resulta da ação de arestas de corte localizadas na periferia e na face da fresa.

No fresamento de topo, a fresa geralmente gira num eixo vertical com relação à peça de trabalho. Pode ser inclinada para usinar superfícies cônicas. As arestas cortantes estão localizadas tanto na face terminal da fresa quanto na periferia do corpo da fresa.

APLICAÇÕES

A MRR e as aplicações estão fortemente relacionadas. Para cada diferente aplicação temos um diferente MRR que aumenta com a área da fresa que age sobre a peça de trabalho. O Catálogo Dormer mais recente foi elaborado com ícones simples que mostram as diversas aplicações.

Fresamento lateral	Fresamento facial	Fres. de ranhuras	Fres. de mergulho	Fres. de rampas
A profundidade radial do corte deverá ser inferior a 0.25 do diâmetro da fresa de topo.	A profundidade radial do corte não deverá ser mais de 0.9 do diâmetro, a profundidade axial do corte menor que 0.1 do diâmetro.	Usinagem de um rasgo para chaveta. A profundidade radial do corte é igual ao diâmetro da fresa de topo.	Só é possível furar a peça de trabalho com uma fresa de topo com corte central. Nesta operação o avanço deverá ser dividido por 2.	Entradas tanto axial quanto radial na peça de trabalho.

SOLUÇÃO DE PROBLEMAS NO FRESAMENTO

PROBLEMA	CAUSA	SOLUÇÃO
Quebra	Remoção exagerada de material	Diminuir o avanço por faca
	Avanço elevado demais	Diminuir o avanço
Desgaste	Comprimento dos canais ou total grandes demais	Introduzir mais a haste no porta-ferramenta, utilizar fresa de topo mais curta
	Material da peça de trabalho duro demais	Verificar Catálogo ou Selector para ferramenta correta com material de classe mais elevada e/ou revestimento adequado
	Avanço e velocidade inadequados	Verificar Catálogo ou Selector para parâmetros de corte corretos
	Evacuação de cavacos deficientes	Reposicionar as linhas do refrigerante
	Fresamento convencional	Fresamento ascendente
	Hélice de corte inadequada	Ver recomendações no Catálogo/ Selector para alternativa correta de ferramenta
Escamação	Taxa de avanço elevada demais	Reduzir taxa de avanço
	Trepidação	Reduzir as RPM
	Baixa velocidade de corte	Aumentar as RPM
	Fresamento convencional	Fresamento ascendente
	Rigidez da ferramenta insuficiente	Escolher uma ferramenta mais curta e/ou colocar a haste mais para dentro do porta ferramentas
	Rigidez insuficiente da peça de trabalho	Fixar firmemente a peça de trabalho
Vida útil curta da ferramenta	Material de trabalho tenaz	Verificar Catálogo ou Selector por alternativa correta da ferramenta
	Ângulo de corte e alívio primário inadequados	Mudar para ângulo de corte correto
	Atrito fresa/ peça de trabalho	Utilizar ferramenta revestida
Acabamento da superfície ruim	Avanço rápido demais	Diminuir para avanço correto
	Velocidade baixa demais	Aumentar a velocidade
	Cavacos mordidos	Diminuir a remoção de material
	Desgaste da ferramenta	Substituir ou reafiar a ferramenta
	Acúmulo de cavacos	Mudar para ferramenta com hélice maior
	Cavacos falsos	Aumentar a quantidade do fluido refrigerante

PROBLEMA	CAUSA	SOLUÇÃO
Baixa precisão na peça de trabalho	Deflexão da ferramenta	Escolher uma ferramenta mais curta e/ou colocar a haste mais para dentro do porta-ferramentas
	Número de canais insuficiente	Usar uma ferramenta com mais canais
	Porta-ferramentas solto ou gasto	Consertar ou substituir o porta-ferramenta
	Baixa rigidez do porta-ferramenta	Substituir por porta-ferramenta mais curto/ rígido
	Rigidez deficiente do fuso	Utilizar fuso maior
Trepidação	Avanço e velocidade elevados demais	Corrigir avanço e velocidade com o auxílio do Catálogo/ Selector
	Comprimento dos canais ou total grandes demais	Introduzir mais a haste no porta-ferramenta, usar fresa de topo mais curta
	Corte profundo demais	Diminuir profundidade do corte
	Não há rigidez suficiente (máquina e porta-ferramenta)	Verificar o porta-ferramenta e trocar se necessário

Español		Dureza	Resistencia a la tracción	ISO
Aplicación por grupo de material		HB	N/mm ²	
1. Acero	1.1 Acero blando	< 120	< 400	P 1
	1.2 Acero de construcción/cementación	< 200	< 700	P 1
	1.3 Acero al carbono	< 250	< 850	P 2
	1.4 Acero aleado	< 250	< 850	P 3
	1.5 Acero aleado/temple y revenido	> 250 < 350	> 850 < 1200	P 4
	1.6 Acero aleado/temple y revenido	> 350	> 1200 < 1620	H 1
	1.7 Acero aleado cementado	49-55HRC	> 1620	H 3
	1.8 Acero aleado cementado	55-63HRC	> 1980	H 4
2. Acero inoxidable	2.1 Acero inoxidable fácil mecanizado	< 250	< 850	M 1
	2.2 Austenítico	< 320	< 1100	M 3
	2.3 Ferrítico, Ferr. + Aust., Marten	< 300	< 1000	M 2
	2.4 Acero inoxidable Templado	>320 <410	>1100 <1400	S 2
3. Hierro Fundido	3.1 Con grafito laminar	< 150	> 500	K 1
	3.2 Con grafito laminar	> 150 <300	> 500 < 1000	K 2
	3.3 Con graf. laminar, fundic. maleable	< 200	< 700	K 3
	3.4 Con graf. laminar, fundic. maleable	> 200 < 300	> 700 < 1000	K 4
4. Titanio	4.1 Titanio no aleado	< 200	< 700	S 1
	4.2 Titanio aleado	< 270	< 900	S 2
	4.3 Titanio aleado	> 270 < 350	> 900 ≤ 1250	S 3
	4.4 Titanio aleado	< 150	< 500	S 1
5. Nickel	5.1 Niquel no aleado	< 270	> 900	S 2
	5.2 Niquel aleado	> 270 < 350	> 900 < 1200	S 3
	5.3 Niquel aleado	< 100	< 350	N 3
6. Cobre	6.1 Cobre	< 200	< 700	N 4
	6.2 β-Latón, bronce	< 200	< 700	N 3
	6.3 α-Latón	< 200	< 700	N 3
	6.4 Metal AMPCO	< 470	< 1500	N 4
7. Aluminio Magnesio	7.1 Al, Mg, no aleado	< 100	< 350	N 1
	7.2 Al aleado con Si < 0.5%	< 150	< 500	N 1
	7.3 Al aleado con Si > 0.5% < 10%	< 120	< 400	N 1
	7.4 Al aleado, Si > 10% Reforzado por filamentos Al-aleados, Mg-aleados	< 120	< 400	N 2
8. Materiales Sintéticos	8.1 Termoplásticos	---	---	O
	8.2 Plásticos endurecidos por calor	---	---	O
	8.3 Materiales plásticos reforzados	---	---	O
9. Materiales duros	9.1 Cerametales (metales-cerámicas)	< 550	< 1700	H
	10. Grafito	---	< 100	O



EJEMPLOS DE MATERIALES DE LAS PIEZAS DE TRABAJO EN DIFERENTES NORMAS

AMG	EN	W.N.	DIN	BS	SS	USA	UNS	ISO
1.1		1.1015, 1.1013	Rf60, Rf100	230M67, 050A12	1160	Leaded Steels	G12120	P 1
1.2	EN 10 025 - S235JRG2	1.1012, 1.1053, 1.7131	S37-2, 16MnCr5, S160-2	060A35, 080M40, 4360-50B	1312, 1412, 1914	135, 30	G10100	P 1
1.3	EN 10 025 - E295	1.1191, 1.0601	CK45, C60	080M46, 080A62	1550, 2142, 2172	1024, 1060, 1061	G10600	P 2
1.4	EN 10 083-1 - 42CrMo4 - EN 10 270-2	1.7225, 1.3505, 1.6582, 1.3247	42CrMo4, 100Cr6, 34CrNiMo6, S2-10-1-8	708M4042, 817M40, 534A98, BM2, BT42	1672-04, 2090, 2244-02, 2541-02	4140, A2, 4340, M42, M2	G41270, G41470, T30102, T11342	P 3
1.5	EN ISO 4957 - H56-52 - EN ISO 4957 - H56-52-5	1.2510, 1.2713, 1.3247, 1.2080	100MnCrW12, 55NiCrMoV6, X210Cr12, S2-10-1-8	B01, BM2, BT42, 828 M40, 830M31	2244-04, 2541-03, 2850, 2722, 2723	01, L6, M42, D3, A2, M2, 4140, 8630	G96300, T30102, T11302, T30403, T11342	P 4
1.6	EN ISO 4957 - H52-9-1-8	1.2510, 1.2713, 1.3247, 1.2080	100MnCrW12, X210Cr12, S2-10-1-8	801, 826 M40, 830M31	2244-05, 2541-05, HARDOX 400	01, L6, M42, D3, 4140, 8130	T30403, G41400, J14047	H 1
1.7	EN ISO 4957 - H52-9-1-8	1.2510	100MnCrW4	B01, BD3, BH13	HARDOX 500			H 3
1.8	EN ISO 4957 - X40CrMoV5-1	1.3343, 1.2344	S6-5-2, GX40CrMoV5-1	BM2, BH13	2242 HARDOX 600			H 4
2.1	EN 10 088-3 - X14CrMoS17	1.4305, 1.4104	X10CrNiS189, X12CrMoS17	303 S21, 416 S37	2301, 2312, 2314, 2346, 2380	303, 416, 430F	S30300, S41600, S43020	M 1
2.2	EN 10 088-2-0-3 - 1.4301+AT	1.4301, 1.4541, 1.4571	X5CrNi189 X10CrNiMoTi1810	304 S15, 321 S17, 316 S, 320 S12	2310, 2333, 2337, 2343, 2353, 2377	304, 321, 316	S30400, S32100, S31600	M 3
2.3	EN 10 088-3 - 1.4460	1.4460, 1.4512, 1.4582	X8CrNiMo275, X4CrNiMoN6257	317 S16, 316 S16	2324, 2387, 2570	409, 430, 436	S40900, S4300, S43600	M 2
2.4	EN 1.4547	1.4547	X2CrNiMo20-18-6	HR41	2378	17-4PH	S31254	S 2
3.1	EN 1561 - EN-JL1030	0.6010, 0.6040	GG10, GG40	Grade150, Grade 400	0120, 0212, 0814	ASTM A48 class 20	F11401, F12801	K 1
3.2	EN 1561 - EN-JL1050	0.6025, 0.6040	GG25, GG40	Grade200, Grade 400	0125, 0130, 0140, 0217	ASTM A48 class 40, STM A48 class 60	F12801, F14101	K 2
3.3	EN 1561 - EN-JL2040	0.7040, 0.7070, 0.8145, 0.8045	GG40, GGG70, GTS45-06, GTW45-07	GG40, GGG70, GTS45-06, GTW45-07	0219, 0717, 0727, 0732, 0852	ASTM A220 grade 40010, ASTM A602 grade M4504	F22830, F20001	K 3
3.4	EN 1561 - EN-JL2050	0.7040, 0.7070, 0.8145, 0.8045	GG40, GGG70, GTS45-06, GTW45-07	420/12, P4407, 700/2, 30g/72	0221, 0223, 0737, 0854	ASTM A220 grade 90001, ASTM A602 grade M8501	F26230, 20005	K 4
4.1		3.7024LN	T199 8	TA1 to 9	T199 8	ASTM B265 grade 1	R50250	S 1
4.2		3.7164LN, 3.7119LN	TA16V4, TA165n2	TA10 to 14, TA17	TA16V4, TA165Sn2	AMS4928	R54790	S 2
4.3		3.7164LN, 3.7174LN, 3.7184LN	TA16V4, TA16V5Sn2, TA14MoSn2	TA10 to 13, TA28	TA16V5Sn2	AMS4928, AMS4971	R56400, R54790	S 3
5.1		2.4060, 2.4066	Nickel200, 270, N169 6	NA 11, NA12	N200, N4270	Nickel 200, Nickel 230	N02200, N02230	S 1
5.2		2.4630LN, 2.4602, 2.4650LN	Nimonic 75, Monel 400, Hastelloy C, Inconel 600	HR203, 3027-76		Nimonic 75, Monel 400, Hastelloy, Inconel 600	N06075, N10002, N04400, N06600	S 2
5.3		2.4668LN, 2.4631LN, 2.6554LN	Inconel 718, Nimonic 80A, Waspaloy	HR8, HR401, 601		Inconel 718, 625, Nimonic 80	N07718, N07080, N06625	S 3
6.1	EN 1652 - CW004A	2.0060, 2.0070	E-Cu57, SE-Cu	C101	5010	101	C10100, C1020	N 3
6.2	EN 1652 - CW612N	2.0380, 2.0360, 2.1030, 2.1080	CuZn39Pb2, CuZn40, CuSn8, CuSn6Zn	CZ120, CZ109, PB104	5168		C28000, C37710	N 4
6.3	EN 1652 - CW608L	2.0321, 2.0260	CuZn37, CuZn28	CZ108, CZ106	5150		C2600, C27200	N 3
6.4			Ampcoo 18, Ampco 25	AB1 type	5238, JM7-20			N 4
7.1	EN 485-2 - EN AW-1070A	3.0255	A189 5	LMO, 1 B (1050A)	4005	EC, 1060, 1100	A91060, A91100	N 1
7.2	EN 755-2 - EN AW-5005	3.1355, 3.3525	AlCuMg2, AlMg2Mn0.8	LM5, 10, 12, N4 (5251)	4106, 4212	380, 520.0, 520.2, 2024, 6061	A03800, A05200, A92024	N 1
7.3	EN 1706 - EN AC-42000	3.2162.05, 3.2341.01	GD-ALSi8Cu, G-ALSi5Mg	LM2, 4, 16, 18, 21, 22, 24, 25, 26, 27, L-109	4244	319.0, 333.0, 319.1, 356.0	A03190, A03330, C35600	N 1
8.1	SS-EN 1706 - EN AC-47000	3.2581.01	G-ALSi18, G-ALSi12	LM6, 12, 13, 20, 28, 29, 30	4260, 4261, 4262	4032, 222.1, A332.0	A94032, A02220, A13320	N 2
8.2			Polystyrene, Nylon, PVC Cellulose, Acetate & Nitrate			Polystyrene, Nylon, PVC		O
8.3			Ebonite, Tufnol, Bakelite			Bakelite		O
9.1			Kevlar, Pinned Circuit boards			Kevlar		O
10.1			Ferroc, Ferroitanit					H
			Graphite					O

Tabla de Velocidad de Corte



		Vc															
m/Min		5	8	10	15	20	25	30	40	50	60	70	80	90	100	110	150
Feet/Min		16	26	32	50	66	82	98	130	165	197	230	262	296	330	362	495
Ø		RPM															
mm	inch																
1,00		1592	2546	3183	4775	6366	7958	9549	12732	15916	19099	22282	25465	28648	31831	35014	47747
1,50		1061	1698	2122	3183	4244	5305	6366	8488	10610	12732	14854	16977	19099	21221	23343	31831
2,00		796	1273	1592	2387	3183	3979	4775	6366	7958	9549	11141	12732	14324	15916	17507	23873
2,50		637	1019	1273	1910	2546	3183	3820	5093	6366	7639	8913	10186	11459	12732	14006	19099
3,00		531	849	1061	1592	2122	2653	3183	4244	5305	6366	7427	8488	9549	10610	11671	15916
3,18	1/8	500	801	1001	1501	2002	2502	3003	4004	5005	6006	7007	8008	9009	10010	11011	15015
3,50		455	728	909	1364	1819	2274	2728	3638	4547	5457	6366	7276	8185	9095	10004	13642
4,00		398	637	796	1194	1592	1989	2387	3183	3979	4775	5570	6366	7162	7958	8754	11937
4,50		354	566	707	1061	1415	1768	2122	2829	3537	4244	4951	5659	6366	7074	7781	10610
4,76	3/16	334	535	669	1003	1337	1672	2006	2675	3344	4012	4681	5350	6018	6687	7356	10031
5,00		318	509	637	955	1273	1592	1910	2546	3183	3820	4456	5093	5730	6366	7003	9549
6,00		265	424	531	796	1061	1326	1592	2122	2653	3183	3714	4244	4775	5305	5836	7958
6,35	1/4	251	401	501	752	1003	1253	1504	2005	2506	3008	3509	4010	4511	5013	5514	7519
7,00		227	364	455	682	909	1137	1364	1819	2274	2728	3183	3638	4093	4547	5002	6821
7,94	5/16	200	321	401	601	802	1002	1203	1604	2004	2405	2806	3207	3608	4009	4410	6013
8,00		199	318	398	597	796	995	1194	1592	1989	2387	2785	3183	3581	3979	4377	5968
9,00		177	283	354	531	707	884	1061	1415	1768	2122	2476	2829	3183	3537	3890	5305
9,53	3/8	167	267	334	501	668	835	1002	1336	1670	2004	2338	2672	3006	3340	3674	5010
10,00		159	255	318	477	637	796	955	1273	1592	1910	2228	2546	2865	3183	3501	4775
11,11	7/16	143	229	287	430	573	716	860	1146	1433	1719	2006	2292	2579	2865	3152	4298
12,00		133	212	265	398	531	663	796	1061	1326	1592	1857	2122	2387	2653	2918	3979
12,70	1/2	125	201	251	376	501	627	752	1003	1253	1504	1754	2005	2256	2506	2757	3760
14,00		114	182	227	341	455	568	682	909	1137	1364	1592	1819	2046	2274	2501	3410
14,29	9/16	111	178	223	334	446	557	668	891	1114	1337	1559	1782	2005	2228	2450	3341
15,00		106	170	212	318	424	531	637	849	1061	1273	1485	1698	1910	2122	2334	3183
15,88	5/8	100	160	200	301	401	501	601	802	1002	1203	1403	1604	1804	2004	2205	3007
16,00		99	159	199	298	398	497	597	796	995	1194	1393	1592	1790	1989	2188	2984
17,46	11/16	91	146	182	273	365	456	547	729	912	1094	1276	1458	1641	1823	2005	2735
18,00		88	141	177	265	354	442	531	707	884	1061	1238	1415	1592	1768	1945	2653
19,05	3/4	84	134	167	251	334	418	501	668	835	1003	1170	1337	1504	1671	1838	2506
20,00		80	127	159	239	318	398	477	637	796	955	1114	1273	1432	1592	1751	2387
24,00		66	106	133	199	265	332	398	531	663	796	928	1061	1194	1326	1459	1989
25,00		64	102	127	191	255	318	382	509	637	764	891	1019	1146	1273	1401	1910
27,00		59	94	118	177	236	295	354	472	589	707	825	943	1061	1179	1297	1768
30,00		53	85	106	159	212	265	318	424	531	637	743	849	955	1061	1167	1592
32,00		50	80	99	149	199	249	298	398	497	597	696	796	895	995	1094	1492
36,00		44	71	88	133	177	221	265	354	442	531	619	707	796	884	973	1326
40,00		40	64	80	119	159	199	239	318	398	477	557	637	716	796	875	1194
50,00		32	51	64	95	127	159	191	255	318	382	446	509	573	637	700	955

HV Vickers	HRC Rockwell	HB Brinell	Newton/ mm ²	Tons/ sq. in.
940	68			
900	67			
864	66			
829	65			
800	64			
773	63			
745	62			
720	61			
698	60			
675	59			
655	58		2200	142
650		618	2180	141
640		608	2145	139
639	57	607	2140	138
630		599	2105	136
620		589	2070	134
615	56	584	2050	133
610		580	2030	131
600		570	1995	129
596	55	567	1980	128
590		561	1955	126
580		551	1920	124
578	54	549	1910	124
570		542	1880	122
560	53	532	1845	119
550		523	1810	117
544	52	517	1790	116
540		513	1775	115
530		504	1740	113
527	51	501	1730	112
520		494	1700	110
514	50	488	1680	109
510		485	1665	108
500		475	1630	105
497	49	472	1620	105
490		466	1595	103
484	48	460	1570	102
480		456	1555	101
473	47	449	1530	99
470		447	1520	98
460		437	1485	96
458	46	435	1480	96
450		428	1455	94
446	45	424	1440	93
440		418	1420	92

HV Vickers	HRC Rockwell	HB Brinell	Newton/ mm ²	Tons/ sq. in.
434	44	413	1400	91
423	43	402	1360	88
413	42	393	1330	86
403	41	383	1300	84
392	40	372	1260	82
382	39	363	1230	80
373	38	354	1200	78
364	37	346	1170	76
355	36	337	1140	74
350		333	1125	73
345	35	328	1110	72
340		323	1095	71
336	34	319	1080	70
330		314	1060	69
327	33	311	1050	68
320		304	1030	67
317	32	301	1020	66
310	31	295	995	64
302	30	287	970	63
300		285	965	62
295		280	950	61
293	29	278	940	61
290		276	930	60
287	28	273	920	60
285		271	915	59
280	27	266	900	58
275		261	880	57
272	26	258	870	56
270		257	865	56
268	25	255	860	56
265		252	850	55
260	24	247	835	54
255	23	242	820	53
250	22	238	800	52
245		233	785	51
243	21	231	780	50
240		228	770	50
235		223	755	49
230		219	740	48
225		214	720	47
220		209	705	46
215		204	690	45
210		199	675	44
205		195	660	43
200		190	640	41

TOLERANCIA



Tol	Ø mm							
	> 1 ≤ 3	> 3 ≤ 6	> 6 ≤ 10	> 10 ≤ 18	> 18 ≤ 30	> 30 ≤ 50	> 50 ≤ 80	> 80 ≤ 120
	µm							
e8	-14 / -28	-20 / -38	-25 / -47	-32 / -59	-40 / -73	-50 / -89	-60 / -106	-72 / -126
f6	-6 / -12	-10 / -18	-13 / -22	-16 / -27	-20 / -33	-25 / -41	-30 / -49	-36 / -58
f7	-6 / -16	-10 / -22	-13 / -28	-16 / -34	-20 / -41	-25 / -50	-30 / -60	-36 / -71
h6	0 / -6	0 / -8	0 / -9	0 / -11	0 / -13	0 / -16	0 / -19	0 / -22
h7	0 / -10	0 / -12	0 / -15	0 / -18	0 / -21	0 / -25	0 / -30	0 / -35
h8	0 / -14	0 / -18	0 / -22	0 / -27	0 / -33	0 / -39	0 / -46	0 / -54
h9	0 / -25	0 / -30	0 / -36	0 / -43	0 / -52	0 / -62	0 / -74	0 / -87
h10	0 / -40	0 / -48	0 / -58	0 / -70	0 / -84	0 / -100	0 / -120	0 / -140
h11	0 / -60	0 / -75	0 / -90	0 / -110	0 / -130	0 / -160	0 / -190	0 / -220
h12	0 / -100	0 / -120	0 / -150	0 / -180	0 / -210	0 / -250	0 / -300	0 / -350
k10	+40 / 0	+48 / 0	+58 / 0	+70 / 0	+84 / 0	+100 / 0	+120 / 0	+140 / 0
k12	+100 / 0	+120 / 0	+150 / 0	+180 / 0	+210 / 0	+250 / 0	+300 / 0	+350 / 0
m7	+2 / +12	+4 / +16	+6 / +21	+7 / +25	+8 / +29	+9 / +34	+11 / +41	+13 / +48
js14	+/- 125	+/- 150	+/- 180	+/- 215	+/- 260	+/- 310	+/- 370	+/- 435
js16	+/- 300	+/- 375	+/- 450	+/- 550	+/- 650	+/- 800	+/- 950	+/- 1100
H7	+10 / 0	+12 / 0	+15 / 0	+18 / 0	+21 / 0	+25 / 0	+30 / 0	+35 / 0
H8	+14 / 0	+18 / 0	+22 / 0	+27 / 0	+33 / 0	+39 / 0	+46 / 0	+54 / 0
H9	+25 / 0	+30 / 0	+36 / 0	+43 / 0	+52 / 0	+62 / 0	+74 / 0	+87 / 0
H12	+100 / 0	+120 / 0	+150 / 0	+180 / 0	+210 / 0	+250 / 0	+300 / 0	+350 / 0
P9	-6 / -31	-12 / -42	-15 / -51	-18 / -61	-22 / -74	-26 / -86	-32 / -106	-37 / -124

1µm = 0.001mm

TALADRADO

INSTRUCCIONES GENERALES PARA EL TALADRADO

1. Seleccione la broca más apropiada para la aplicación, en función del material que se debe mecanizar, la capacidad de la máquina herramienta y el refrigerante que se va a utilizar.
2. La falta de rigidez del componente y del husillo de la máquina herramienta puede ocasionar daños en la broca, además de en el componente y en la máquina. Deberá garantizarse por tanto la máxima estabilidad en todo momento. Dicha estabilidad puede mejorarse seleccionando la broca más corta posible para la aplicación.
3. La sujeción de la herramienta es un aspecto importante en la operación de taladrar y no se puede permitir que la broca resbale o que se mueva en el portaherramientas.
4. El uso de refrigerantes y lubricantes adecuados se recomienda en función de la operación específica de taladrado. Cuando utilice refrigerantes y lubricantes, asegure un suministro abundante, especialmente en la punta de la broca.
5. La evacuación de la viruta durante el taladrado es esencial para garantizar un correcto procedimiento del taladrado. No permita que las estrías de la broca se atasquen de virutas.
6. Al reafilar la broca, cerciórese de que se ha eliminado todo el desgaste y de que se produce la geometría de punta correcta.

TAMAÑO DEL AGUJERO

A medida que aumenta la complejidad de las configuraciones de geometría, sustrato y recubrimiento, aumenta también la capacidad de la broca para producir tamaños de agujero más precisos. En general, una herramienta con geometría estándar logrará, como máximo, un tamaño de agujero H12. Sin embargo, a medida que la configuración de la broca se hace más compleja, el tamaño del agujero puede llegar, en condiciones favorables, hasta una tolerancia H8. A continuación se muestran las tolerancias de agujero que se puede lograr para cada tipo de brocas:

- Brocas HSS para aplicaciones generales – H12
- Brocas HSS/HSS-E con estrías parabólicas para agujeros profundos – H10
- Metal duro con recubrimiento de alto rendimiento – H8/H9

ESTRATEGIA DE TALADRADO DE AGUJEROS PROFUNDOS

Al taladrar agujeros profundos, pueden adoptarse varios métodos para lograr la profundidad requerida. En el ejemplo se muestran cuatro formas de taladrar un agujero con una profundidad de 10 veces el diámetro de la broca.

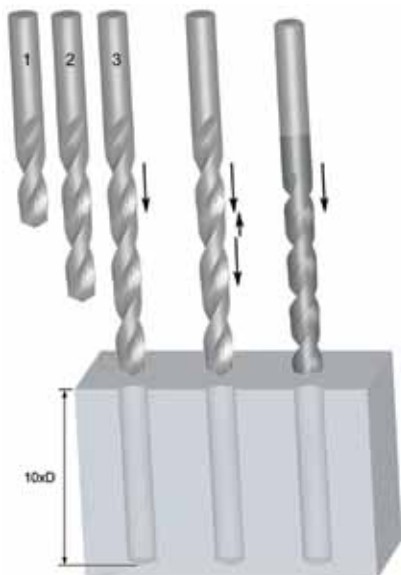

	Taladro en series	Series Drilling
Número de brocas	3 (2,5 xD, 6 xD, 10 xD)	2 (2,5 xD, 10 xD)
Tipo de broca	Geometría estándar, aplicaciones generales	Geometría estándar, aplicaciones generales
+ / -	Caro Largo	Más rentable Rápido

	Taladro con desahogo (misma broca)	Taladro en 1 paso
Número de brocas	1 (10 xD)	1 (10 xD)
Tipo de broca	Geometría estándar, aplicaciones generales	Herramientas específicas
+ / -	Largo	Rentable Rápido

PROBLEMAS EN EL TALADRADO

PROBLEMA	CAUSA	REMEDIO
Rotura o torsión en la espiga	Malas condiciones entre el mango y el portaherramientas	Comprobar que el mango y el portaherramientas están limpios y no están dañados
Grietas en el alma de la herramienta	Avance demasiado alto	Reducir el avance a un valor óptimo
	Insuficiente holgura inicial	Reafilarse según las especificaciones correctas
	Alma excesivamente delgada	Reafilarse según las especificaciones correctas
	Duro impacto en la punta de la broca	Evitar impactos en la punta de la broca. Tener precaución con las brocas del mango cónico al introducirlas/expulsarlas del husillo
Desgaste en las esquinas exteriores	Excesiva velocidad	Reducir la velocidad al valor óptimo, debe poder incrementarse el avance
Rotura de las esquinas exteriores	Montaje de la herramienta inestable	Reducir el movimiento en el componente
Labios de corte astillados	Excesiva holgura inicial	Reafilarse según las especificaciones correctas
Rotura en la salida de la estría	Estrías atascadas	Adoptar un concepto de taladrado con desahogo/en serie
	Resbalamiento de la broca	Asegurar que la broca está bien sujeta en el portapinzas y el husillo
Acabado en espiral del agujero	Avance insuficiente	Incrementar el avance
	Exactitud del posicionamiento mala	Usar una broca de centrar antes del taladrado
Tamaño del agujero demasiado grande	Geometría de la punta incorrecta	Corregir la geometría de la punta
	Holgura de la viruta deficiente	Ajustar la velocidad y el avance y la longitud de desahogo para lograr una viruta más manejable

ESCARIADO

INSTRUCCIONES GENERALES PARA EL ESCARIADO

Para obtener los mejores resultados con los escariadores, es esencial hacerlos 'trabajar'. Un error frecuente es el de preparar orificios para escariar dejando dentro poco material. Si se deja en el orificio material insuficiente antes de escariar, el escariador rozará, se desgastará rápidamente y el resultado será la pérdida de diámetro. Para garantizar un buen rendimiento, también es importante no dejar demasiado material en el agujero. (Véase el apartado "Eliminación de material" a continuación).

1. Seleccionar el tipo óptimo de escariador y las velocidades y avances óptimos para la aplicación. Asegurar que los agujeros pretaladrados sean del diámetro correcto.
2. La pieza de trabajo debe sujetarse rígida y el husillo de la máquina no debe tener juego.
3. El portapinzas en el que se sujeta un escariador de mango recto debe ser de buena calidad. Si el escariador resbala en el portapinzas y el avance es automático, el escariador podría romperse.
4. Mantener al mínimo el vuelo de la herramienta respecto al husillo de la máquina.
5. Usar los lubricantes recomendados para prolongar la vida útil del escariador y asegurar que el fluido llegue a los filos de corte. Como la operación de escariar no es un trabajo de corte pesado, normalmente bastará una disolución 40:1 de aceite soluble. Cuando se trata de mecanizado en seco, se puede emplear aire a presión (ej. con el mecanizado de acero de fundición gris).
6. No permitir que las estrías del escariador se atasquen de virutas.
7. Antes de volver a reafilar el escariador, comprobar la concentricidad entre centros. En la mayoría de los casos, sólo habrá que rectificar el paso del bisel.
8. Mantener afilados los escariadores. El reafilado frecuente es rentable, pero es importante entender que los escariadores sólo cortan en el chaflán de entrada y no en las superficies entre estrías. Por lo tanto, sólo hay que rectificar dichas superficies. La exactitud de la rectificación es importante para la calidad del acabado del orificio y la vida útil de la herramienta.

ELIMINACIÓN DE MATERIAL

La eliminación de material recomendada al escariar depende del material de aplicación y el acabado de la superficie del orificio pretaladrado. En la siguiente tabla se dan las directrices generales para la eliminación de material:

Tamaño del agujero escariado (mm)	Con pretaladrado	Con pretaladrado de núcleo	Tamaño del agujero escariado (pulgadas)	Con pretaladrado	Con pretaladrado de núcleo
Menos de 4	0.1	0.1	Menos de 3/16	0.004	0.004
De 4 a 11	0.2	0.15	3/16 a 1/2	0.008	0.006
De 11 a 39	0.3	0.2	1/2 a 1.1/2	0.010	0.008
De 39 a 50	0.4	0.3	1.1/2 a 2	0.016	0.010

LÍMITES DE TOLERANCIA



1. EN EL DIÁMETRO DE CORTE DE LOS ESCARIADORES ESTÁNDAR

El diámetro (d_1) se mide sobre la superficie circular entre estrías inmediatamente detrás del bisel o paso cónico. La tolerancia se ajusta a DIN 1420 y sirve para producir agujeros H7.

TOLERANCIA DEL ESCARIADOR			
Diámetro (mm)		Límite de tolerancia (mm)	
Por encima de	Hasta e incluido	Alto +	Bajo +
	3	0.008	0.004
3	6	0.010	0.005
6	10	0.012	0.006
10	18	0.015	0.008

TOLERANCIA DEL ESCARIADOR			
Diámetro (mm)		Límite de tolerancia (mm)	
Por encima de	Hasta e incluido	Alto +	Bajo +
18	30	0.017	0.009
30	50	0.021	0.012
50	80	0.025	0.014

2. EN UN AGUJERO H7

La tolerancia más común en un agujero acabado es H7 (ver la tabla de abajo). Para cualquier otra tolerancia, ver la figura y la tabla del punto 3 (se muestra más abajo); esta tabla se puede usar para calcular el ancho y la ubicación de tolerancia de los escariadores.

TOLERANCIA DEL AGUJERO			
Diámetro (mm)		Límite de tolerancia (mm)	
Por encima de	Hasta e incluido	Alto +	Bajo +
	3	0.010	0
3	6	0.012	0
6	10	0.015	0
10	18	0.018	0

TOLERANCIA DEL AGUJERO			
Diámetro (mm)		Límite de tolerancia (mm)	
Por encima de	Hasta e incluido	Alto +	Bajo +
18	30	0.021	0
30	50	0.025	0
50	80	0.030	0

3. Cuando es necesario definir las dimensiones para un escariador especial para cortar según una tolerancia específica, por ejemplo D8, se puede usar esta guía.

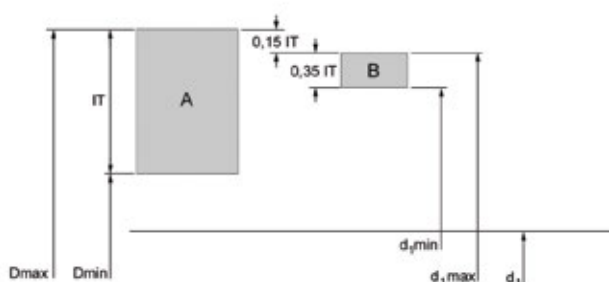

A = Tolerancia del Agujero
 B = Tolerancia del Escariador
 IT = Ancho de tolerancia
 Dmax = Diámetro máx. del agujero
 Dmin = Diámetro mín. del agujero
 d_1 = Diámetro nominal
 $d_{1,max}$ = Diámetro máx. del escariador
 $d_{1,min}$ = Diámetro mín. del escariador

Ancho de tolerancia (micrones)	Ancho de tolerancia del diámetro (mm)							
	por encima de 1 incl. 3	por encima de 3 incl. 6	por encima de 6 incl. 10	por encima de 10 incl. 18	por encima de 18 incl. 30	por encima de 30 incl. 50	por encima de 50 incl. 80	por encima de 80 incl. 120
IT5	4	5	6	8	9	11	13	15
IT6	6	8	9	11	13	16	19	22
IT7	10	12	15	18	21	25	30	35
IT8	14	18	22	27	33	39	46	54
IT9	25	30	36	43	52	62	74	87
IT10	40	48	58	70	84	100	120	140
IT11	60	75	90	110	130	160	190	220
IT12	100	120	150	180	210	250	300	350

por ejemplo: agujero de 10 mm con tolerancia D8, diám. máx. = 10,062, diám. mín. = 10,040, toler. del agujero (IT8) = 0,022

Límite máximo: $0.15 \times$ tolerancia de agujero (IT8) = 0.0033, redondeado = 0.004

Límite mínimo: $0.35 \times$ tolerancia de agujero (IT8) = 0.0077, redondeado = 0.008

Límite máximo para escariador = $10.062 - 0.004 = 10.058$

Límite mínimo para escariador = $10.058 - 0.008 = 10.050$

PROBLEMAS EN EL ESCARIADO

PROBLEMA	CAUSA	REMEDIO
Rotura o torsión en la espiga	Ajuste incorrecto entre el mango y el portaherramientas	Comprobar que el mango y el portaherramientas están limpios y no están dañados
Desgaste rápido de la herramienta	Material insuficiente que eliminar	Aumentar la cantidad de material que eliminar
Agujero sobredimensionado	Excesiva variación de la altura del labio	Reafilar según las especificaciones correctas
	Desplazamiento en el husillo de la máquina	Reparar y rectificar el desplazamiento del husillo
	Desviaciones en el portaherramientas	Reemplazar el portaherramientas
	El mango de la herramienta esta dañado	Sustituir o rectificar el mango
	Forma ovalada de la herramienta	Sustituir o rectificar la herramienta
	Ángulo del paso biselado asimétrico	Reafilar según las especificaciones correctas
	Avance o velocidad de corte de la herramienta demasiado alto	Ajustar las condiciones de corte de acuerdo con el catálogo
Menor tamaño del agujero	Material insuficiente que eliminar	Aumentar la cantidad de material que eliminar
	Excesiva generación de calor en el escariado El agujero se amplía y se contrae	Incrementar la refrigeración
	El diámetro de la herramienta esta desgastado e infradimensionado	Reafilar según las especificaciones correctas
	Avance o velocidad de corte de la herramienta demasiado baja	Ajustar las condiciones de corte de acuerdo con el catálogo
	El agujero pretaladrado es demasiado pequeño	Reducir la cantidad de material que eliminar
Agujeros ovalados y cónicos	Desplazamiento en el husillo de la máquina	Reparar y rectificar el desplazamiento del husillo
	Mal centraje entre la herramienta y el agujero	Usar un escariador guiado
	Ángulo de avance del bisel asimétrico	Reafilar según las especificaciones correctas
Acabado del agujero deficiente	Excesivo material a eliminar	Reducir la cantidad de material que eliminar
	Herramienta muy gastada	Reafilar según las especificaciones correctas
	Ángulo de desprendimiento demasiado pequeño	Reafilar según las especificaciones correctas
	Emulsión o aceite de corte demasiado diluido	Incrementar el % de concentración
	Avance y/o velocidad demasiado baja	Ajustar las condiciones de corte de acuerdo con el catálogo
	Velocidad de corte demasiado alta	Ajustar las condiciones de corte de acuerdo con el catálogo
La herramienta se clava o se rompe	Herramienta muy gastada	Reafilar según las especificaciones correctas
	Chaflán de salida de la herramienta demasiado pequeño	Verificar y reemplazar o modificar la herramienta
	Ancho entre estrías demasiado grande	Verificar y reemplazar o modificar la herramienta
	El material de la pieza de trabajo tiende a retorcerse	Utilizar un escariador regulable para compensar el desplazamiento
	El agujero pretaladrado es demasiado pequeño	Reducir la cantidad de material que eliminar
	Material heterogéneo con inclusiones duras	Usar un escariador de metal duro

ROSCADO

INSTRUCCIONES GENERALES PARA EL ROSCADO

El éxito de toda operación de roscado depende de diversos factores; todos ellos afectan a la calidad del producto acabado.

1. Seleccione el diseño correcto del macho para el material del componente y el tipo de agujero, es decir, pasante o ciego, de la tabla Clasificación de materiales.
2. Asegurar que el componente esté bien sujeto, ya que el movimiento lateral podría causar la rotura del macho o la formación de roscas de mala calidad.
3. Seleccionar el tamaño correcto de la broca de la página del catálogo correspondiente. Asegurarse siempre de mantener al mínimo el endurecimiento del material del componente.
4. Seleccionar la velocidad de corte correcta, según se muestra en la página de productos del catálogo.
5. Usar el fluido de corte adecuado para la aplicación correcta.
6. En aplicaciones NC, asegurar que el valor de avance escogido para el programa sea el correcto. Al usar un accesorio de roscar, se recomienda un 95% a 97% del paso para permitir que el macho genere su propio paso.
7. Siempre que sea posible, sujetar el macho con un dispositivo de roscar de alta calidad con limitador de par; esto asegura el movimiento axial libre del macho y lo sitúa encuadrado en el agujero. Además protege el macho de una posible rotura si “toca fondo” accidentalmente en un agujero ciego.
8. Asegurar la introducción suave del macho en el agujero, ya que un avance desigual podría producir “abocinamiento”.

TABLA DE TOLERANCIAS SOBRE EL MACHO COMPARADA CON TOLERANCIA SOBRE ROSCA INTERNA (TUERCA)

Clase de tolerancia, Macho			Tolerancia, rosca interna (Tuerca)					Aplicación
ISO	DIN	ANSI BS						
ISO 1	4 H	3 B	4 H	5 H				Ajustes sin aumentos
ISO 2	6 H	2 B	4 G	5 G	6 H			Ajustes normales
ISO 3	6 G	1 B			6 G	7 H	8 H	Ajustes con aumentos
-	7 G	-				7 G	8 G	Pérdida de los ajustes por realizar recubrimientos

PROBLEMAS EN LA REALIZACIÓN DE ROSCAS

PROBLEMA	CAUSA	REMEDIO
Tamaño demasiado grande	Tolerancia incorrecta	Cambiar a un macho con una tolerancia inferior en la rosca
	Valor de avance axial incorrecto	Reducir el valor de avance un 5 –10% o incrementar la compresión del portamachos
	Tipo de macho equivocado para la aplicación	Usar un macho con entrada en hélice para roscar agujeros pasantes y un macho con estrías helicoidales para roscar agujeros ciegos. Usar un macho recubierto para prevenir la acumulación de viruta en la estría. Asegurarse de una buena alternativa con el catálogo Dormer o con el “Product Selector”
	Centrado del macho respecto el agujero incorrecto	Asegurar la sujeción del macho y centrar el macho respecto al agujero
	Falta de lubricación	Usar un buen lubricante para prevenir la acumulación de viruta. Mirar la sección de lubricantes en el manual técnico de Dormer
	Velocidad del macho demasiado baja	Seguir las recomendaciones del catálogo Dormer o “Product Selector”.
Tamaño demasiado pequeño	Tipo de macho equivocado para la aplicación	Usar un macho con entrada en hélice para roscar agujeros pasantes y un macho con estrías helicoidales para roscar agujeros ciegos. Usar un macho recubierto para prevenir la acumulación de viruta en la estría. Usar un macho con un ángulo superior. Asegurarse de una buena alternativa con el catálogo Dormer o con el “Product Selector”
	Tolerancia incorrecta	Cambiar a un macho con una tolerancia superior, especialmente en materiales con una tendencia a contraerse, así como el hierro fundido y el acero inoxidable.
	Lubricación incorrecta o falta de lubricación	Usar un buen lubricante para prevenir la acumulación de la viruta. Mirar la sección de lubricantes en el manual técnico de Dormer
	Diámetro del agujero a roscar demasiado pequeño	Aumentar el diámetro de la broca hasta el máximo valor posible. Verifique la medida de la broca previa de rosca
	El material se contrae después del roscado	Mirar la alternativa recomendada en el catálogo Dormer o en el “Product Selector”
Viruta	Tipo de macho equivocado para la aplicación	Cambiar a un macho con un ángulo menor. Cambiar a un macho con un chaflán más largo. Usar un macho con entrada en hélice para roscar agujeros pasantes y un macho con estrías helicoidales para roscar agujeros ciegos. Usar un macho recubierto para prevenir la acumulación de viruta en la estría. Asegurarse de una buena alternativa con el Catálogo Dormer o con el “Product Selector”
	Lubricación incorrecta o falta de lubricación	Usar un buen lubricante para prevenir la acumulación de la viruta. Mirar la sección de lubricantes en el manual técnico de Dormer
	Golpe del macho con el fondo del agujero	Incrementar la profundidad del taladro o disminuir la profundidad de roscado
	Superficie de trabajo demasiado dura	Reducir la velocidad, usar una herramienta recubierta, usar un buen lubricante. Mirar en la sección de mecanizado de acero inoxidable en el manual técnico de Dormer
	Viruta generada en el roscado excesivamente enredada	Evitar un brusco cambio de sentido del macho
	El chaflán de entrada daña el agujero	Revisar la posición axial del macho y reducir el error del centrado del macho en el agujero
	Diámetro del agujero a roscar demasiado pequeño.	Aumentar el diámetro de la broca hasta el máximo valor posible. Verifique la medida de la broca previa de rosca

PROBLEMAS EN LA REALIZACIÓN DE ROSCAS

PROBLEMA	CAUSA	REMEDIO
Rotura	Macho gastado	Rectificar el macho o usar un macho nuevo
	Falta de lubricación	Usar un buen lubricante para prevenir la acumulación de la viruta. Mirar la sección de lubricantes en el manual técnico de Dormer
	Golpe del macho con el fondo del agujero	Incrementar la profundidad del taladro o disminuir la profundidad de roscado
	Velocidad del macho demasiado alta	Reducir la velocidad de corte. Seguir las recomendaciones del Catálogo Dormer o "Product Selector"
	Superficie de trabajo demasiado dura	Reducir la velocidad, usar una herramienta recubierta, usar un buen lubricante. Mirar en la sección de mecanizado de acero inoxidable en el manual técnico de Dormer
	Diámetro del agujero a roscar demasiado pequeño	Aumentar el diámetro de la broca hasta el máximo valor posible. Mirar en las tablas de taladros para roscar
	Potencia demasiado alta	Usar un portamachos de potencia regulable
	El material se contrae después del roscado	Mirar la alternativa recomendada en el Catálogo Dormer o en el "Product Selector"
Desgaste rápido	Macho equivocado para la aplicación realizada	Usar un macho con un ángulo inferior a con un rebaje superior, y/o con un chaflán largo. Usar herramientas recubiertas. Asegurarse de la alternativa correcta en el catálogo Dormer o en el "Product Selector"
	Falta de lubricación	Usar un buen lubricante para prevenir la acumulación de la viruta y la generación de temperatura. Mirar la sección de lubricantes en el manual técnico de Dormer
	Velocidad del macho demasiado alta	Reducir la velocidad de corte. Seguir las recomendaciones del Catálogo Dormer o del "Product Selector"
Acumulación de Viruta	Macho equivocado para la aplicación realizada	Usar un macho con un ángulo inferior a con un rebaje superior. Asegurarse de la alternativa correcta en el Catálogo Dormer o en el "Product Selector"
	Falta de lubricación	Usar un buen lubricante para prevenir la acumulación de la viruta. Mirar la sección de lubricantes en el manual técnico de Dormer
	Tratamiento superficial no adecuado	Elija el macho con el tratamiento superficial recomendado para la aplicación
	Velocidad del macho demasiado lenta	Seguir las recomendaciones del Catálogo Dormer o del "Product Selector"

FRESADO

CONSEJOS GENERALES PARA FRESAR

El fresado es un proceso de mecanizado de superficies, que consiste en el eliminando progresivo de una determinada cantidad de material de la pieza de trabajo con un valor de avance relativamente bajo y con una alta velocidad de rotación.

Las principal características del proceso de fresado es la eliminación de material de cada labio de la fresa, partiéndolo en pequeñas pociones (viruta).

TIPO DE FRESAS

Las tres operaciones básicas de fresado se muestran a continuación: (A) fresado cilíndrico, (B) fresado frontal, (C) fresado de acabado.

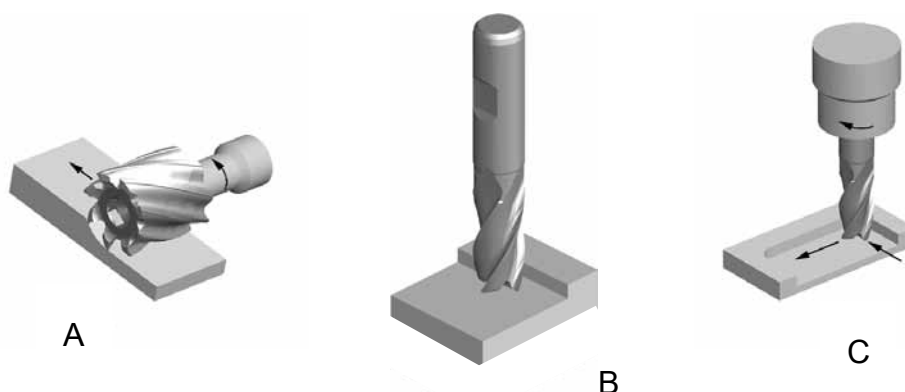

En el fresado cilíndrico el eje de rotación de las fresas es paralelo a la superficie de la pieza de trabajo a mecanizar. La fresa esta rodeada de dientes a lo largo de su circunferencia, cada diente actúa como un punto de corte de la herramienta.

Las fresas usadas para el fresado cilíndrico pueden tener estrías rectas o helicoidales, generando una sección de corte ortogonal o oblicua.

En el fresado frontal, la fresa se monta en el husillo de la máquina o en un portaherramientas, esta fresa tiene un eje de rotación perpendicular a la superficie de la pieza de trabajo. Las fresas frontales, tienen los filos de corte localizados en la periferia de la fresa y en la parte frontal.

En el fresado de acabado, las fresas generalmente rotan sobre un eje vertical a la pieza de trabajo. La fresa también puede estar inclinada respecto a la pieza de trabajo en caso que se quieran realizar superficies cónicas. Los dientes de corte están localizados en la periferia de la fresa y en la parte frontal.

APLICACIONES

La MRR y las aplicaciones están estrechamente relacionadas. Por cada aplicación diferente, nosotros tenemos un valor distinto de MRR que aumenta con el aumento del área de contacto entre la herramienta y la pieza de trabajo. En el catálogo Dormer se muestran las distintas aplicaciones en distintos iconos.

Contorneado	Fresado Frontal	Ranurado	Fresado por penetración	Fresado en rampa
La profundidad radial de corte debe ser inferior a 0,25 x diámetro de la fresa frontal.	La profundidad radial de corte debe ser inferior a 0,9 x diámetro, la profundidad axial de corte debe ser inferior a 0,1 x diámetro de las fresa frontal.	Para mecanizar ranuras para chavetas. La profundidad radial de corte ha de ser igual que el diámetro de la fresa frontal.	Es posible realizar un taladro en la pieza de trabajo solamente con las fresas frontales que tienen corte al centro, en estas aplicaciones el avance tiene que ser reducido	Tanto la profundidad radial como la axial se realizan simultáneamente en la pieza de trabajo.

PROBLEMAS EN EL FRESADO

PROBLEMA	CAUSA	REMEDIO
Rotura	Demasiada cantidad de material eliminado	Disminuir el avance por diente
	Avance demasiado rápido	Disminuir el avance
Desgaste	Longitud del labio o longitud total demasiado larga	Usar un portaherramientas profundo o usar una fresa más corta
	Material de la pieza de trabajo demasiado duro	Comprobar en el catálogo Dormer o en el "Product Selector" la herramienta adecuada para trabajar materiales duros, y su posible recubrimiento
	Avance y velocidad inadecuada	Comprobar en el catálogo Dormer o en el "Product Selector" los parámetros de corte adecuados
	Mala evacuación de la viruta	Mejorar la refrigeración
	Fresado convencional	Fresado inverso
	Hélice de la fresa inadecuada	Mirar las recomendaciones en el catálogo Dormer o en "Product Selector" para una correcta alternativa
Virutas	Valor de avance demasiado alto	Reducir el valor del avance
	Vibración de los dientes	Reducir las RPM
	Velocidad de corte baja	Aumentar las RPM
	Fresado convencional	Fresado inverso
	Rigidez de la herramienta	Cambiar a una herramienta más corta y/o aumentar la profundidad del mango insertada en el portaherramientas
	Rigidez de la pieza de trabajo	Sujetar más fuerte la pieza de trabajo
Corta vida de la herramienta	Material de trabajo resistente	Comprobar en el catálogo Dormer o en "Product Selector" la herramienta correcta o la alternativa más apropiada
	Rebaje del ángulo primario inadecuado	Cambiar a un ángulo de corte apropiado
	Fricción elevada entre la fresa y la pieza de trabajo	Usar una herramienta recubierta
Mal acabado superficial	Avance demasiado rápido	Disminuir el avance
	Velocidad demasiado lenta	Aumentar la velocidad
	Viruta cortante y penetrante	Disminuir la cantidad de material a eliminar
	Desgaste de la herramienta	Sustituir o rectificar la herramienta
	Acumulación de viruta en el filo	Sustituir a una herramienta con un ángulo de hélice superior
	Micro-soldadura de la viruta	Aumentar la cantidad de refrigerante

PROBLEMA	CAUSA	REMEDIO
Inexactitud en la pieza de trabajo	Flexión de la herramienta	Cambiar a una herramienta más corta y/o aumentar la profundidad del mango insertada en el portaherramientas
	Número de labios insuficiente	Usar una herramienta con más labios
	Desgaste del porteherramientas o herramienta mal sujeta	Reparar o reemplazar el portaherramientas
	Baja rigidez en la sujeción de la herramienta	Mejorar la rigidez con una herramienta más corta
	Baja rigidez del husillo de la máquina	Usar un husillo más grande
Vibración	Valores de avance y velocidad demasiado altos	Cambiar a valores de avance y de velocidad correctos con la ayuda del catálogo Dormer o "Product Selector"
	Longitud de los labios o longitud total demasiado larga	Cambiar a una herramienta más corta y /o aumentar la profundidad del mango insertada en el portaherramientas
	Corte demasiado profundo	Disminuir la profundidad de corte
	Rigidez insuficiente (entre la máquina y el portaherramientas)	Corregir el portaherramientas y cambiarlo si es necesario

English		Hardness	Tensile strength	ISO
Application Material Groups		HB	N/mm ²	
1. Steel	1.1 Magnetic soft steel	< 120	< 400	P 1
	1.2 Structural steel, case carburizing steel	< 200	< 700	P 1
	1.3 Plain Carbon steel	< 250	< 850	P 2
	1.4 Alloy steel	< 250	< 850	P 3
	1.5 Alloy steel, Hardened and tempered steel	> 250 < 350	> 850 < 1200	P 4
	1.6 Alloy steel, Hardened and tempered steel	> 350	> 1200 < 1620	H 1
	1.7 Alloy steel, Heat treated	49-55HRC	> 1620	H 3
	1.8 Alloy steel, Hardened & Wear resistant steel	55-63HRC	> 1980	H 4
2. Stainless Steel	2.1 Free machining, Stainless Steel	< 250	< 850	M 1
	2.2 Austenitic,	< 320	< 1100	M 3
	2.3 Ferritic + Austenitic, Ferritic, Martensitic	< 300	< 1000	M 2
	2.4 Precipitation hardened	>320 <410	>1100 <1400	S 2
3. Cast Iron	3.1 Lamellar graphite	< 150	> 500	K 1
	3.2 Lamellar graphite	> 150 <300	> 500 < 1000	K 2
	3.3 Nodular graphite, Malleable Cast Iron	< 200	< 700	K 3
	3.4 Nodular graphite, Malleable Cast Iron	> 200 < 300	> 700 < 1000	K 4
4. Titanium	4.1 Titanium, unalloyed	< 200	< 700	S 1
	4.2 Titanium, alloyed	< 270	< 900	S 2
	4.3 Titanium, alloyed	> 270 < 350	> 900 ≤ 1250	S 3
5. Nickel	5.1 Nickel, unalloyed	< 150	< 500	S 1
	5.2 Nickel, alloyed	< 270	> 900	S 2
	5.3 Nickel, alloyed	> 270 < 350	> 900 < 1200	S 3
6. Copper	6.1 Copper	< 100	< 350	N 3
	6.2 β-Brass, Bronze	< 200	< 700	N 4
	6.3 α-Brass	< 200	< 700	N 3
	6.4 High Strength Bronze	< 470	< 1500	N 4
7. Aluminium Magnesium	7.1 Al, Mg, unalloyed	< 100	< 350	N 1
	7.2 Al alloyed, Si < 0.5%	< 150	< 500	N 1
	7.3 Al alloyed, Si > 0.5% < 10%	< 120	< 400	N 1
	7.4 Al alloyed, Si > 10% Whisker reinforced, Al-alloys MG-alloys	< 120	< 400	N 2
8. Synthetic materials	8.1 Thermoplastics	---	---	O
	8.2 Thermosetting plastics	---	---	O
	8.3 Reinforced plastic materials	---	---	O
9. Hard material	9.1 Cermet (metals-ceramics)	< 550	< 1700	H
	10.1 Graphite	---	< 100	O



EXAMPLES OF WORKPIECE MATERIALS
FROM DIFFERENT STANDARDS

AMG	EN	W.N.	DIN	BS	SS	USA	UNS	ISO
1.1		1.1015, 1.1013	Rf60, Rf100	230M67, 050A12	1160	Leaded Steels	G12120	P 1
1.2	EN 10 025 – S235JRG2	1.1012, 1.1053, 1.7131	S37-2, 16MnCr5, S160-2	060A35, 080M40, 4360-50B	1312, 1412, 1914	135, 30	G10100	P 1
1.3	EN 10 025 – E295	1.1191, 1.0601	CK45, C60	080M46, 080A62	1550, 2142, 2172	1024, 1060, 1061	G10600	P 2
1.4	EN 10 083-1 – 42CrMo4 – EN 10 270-2	1.7225, 1.3505, 1.6582, 1.3247	42CrMo4, 100Cr6, 34CrNiMo6, S2-10-1-8	708M40/42, 817M40, 534A98, BM2, BT42	1672-04, 2090, 2244-02, 2541-02	4140, A2, 4340, M42, M2	G41270, G41470, T30102, T11342	P 3
1.5	EN ISO 4957 – H56-52 – EN ISO 4957 – H56-52-5	1.2510, 1.2713, 1.3247, 1.2080	100MnCrW12, 55NiCrMoV6, X210Cr12, S2-10-1-8	B01, BM2, BT42, 826M40, 830M31	2244-04, 2541-03, 2850, 2722, 2723	01, L6, M42, D3, A2, M2, 4140, 8630	G96300, T30102, T11302, T30403, T11342	P 4
1.6	EN ISO 4957 – H52-9-1-8	1.2510, 1.2713, 1.3247, 1.2080	100MnCrW12, X210Cr12, S2-10-1-8	801, 826 M40, 830M31	2244-05, 2541-05, HARDOX 400	01, L6, M42, D3, 4140, 8130	T30403, G41400, J14047	H 1
1.7	EN ISO 4957 – H52-9-1-8	1.2510	100MnCrW4	BO1, BD3, BH13	HARDOX 500			H 3
1.8	EN ISO 4957 – X40CrMoV5-1	1.3343, 1.2344	S6-5-2, GX40CrMoV5-1	BM2, BH13	2242 HARDOX 600			H 4
2.1	EN 10 088-3 – X14CrMoS17	1.4305, 1.4104	X10CrNiS189, X12CrMoS17	303 S21, 416 S37	2301, 2312, 2314, 2346, 2380	303, 416, 430F	S30300, S41600, S43020	M 1
2.2	EN 10 088-2-0-3 – 1.4301+AT	1.4301, 1.4541, 1.4571	X5CrNi189 X10CrNiMoTi1810	304 S15, 321 S17, 316 S, 320 S12	2310, 2333, 2337, 2343, 2353, 2377	304, 321, 316	S30400, S32100, S31600	M 3
2.3	EN 10 088-3 – 1.4460	1.4460, 1.4512, 1.4582	X8CrNiMo275, X4CrNiMoN6257	317 S16, 316 S16	2324, 2387, 2570	409, 430, 436	S40900, S4300, S43600	M 2
2.4	EN 1.4547	1.4547	X2CrNiMo20-18-6	HR41	2378	17-4PH	S31254	S 2
3.1	EN 1561 – EN-JL1030	0.6010, 0.6040	GG10, GG40	Grade150, Grade 400	0120, 0212, 0814	ASTM A48 class 20	F11401, F12801	K 1
3.2	EN 1561 – EN-JL1050	0.6025, 0.6040	GG25, GG40	Grade200, Grade 400	0125, 0130, 0140, 0217	ASTM A48 class 40, STM A48 class 60	F12801, F14101	K 2
3.3	EN 1561 – EN-JL2040	0.7040, 0.7070, 0.8145, 0.8045	GG40, GGG70, GTS45-06, GTW45-07	GG40, GGG70, GTS45-06, GTW45-07	0219, 0717, 0727, 0732, 0852	ASTM A220 grade 40010, ASTM A602 grade M4504	F22830, F20001	K 3
3.4	EN 1561 – EN-JL2050	0.7040, 0.7070, 0.8145, 0.8045	GG40, GGG70, GTS45-06, GTW45-07	420/12, P4407, 700/2, 30g/72	0221, 0223, 0737, 0854	ASTM A220 grade 90001, ASTM A602 grade M8501	F26230, 20005	K 4
4.1		3.7024LN	T199 8	TA1 to 9	T199 8	ASTM B265 grade 1	R50250	S 1
4.2		3.7164LN, 3.7119LN	TA16V4, TA165n2	TA10 to 14, TA17	TA16V4, TA165Sn2	AMS4928	R54790	S 2
4.3		3.7164LN, 3.7174LN, 3.7184LN	TA16V4, TA16V5Sn2, TA14MoSn2	TA10 to 13, TA28	TA16V5Sn2	AMS4928, AMS4971	R56400, R54790	S 3
5.1		2.4060, 2.4066	Nickel200, 270, N169 6	NA 11, NA12	N200, N4270	Nickel 200, Nickel 230	N02200, N02230	S 1
5.2		2.4630LN, 2.4602, 2.4650LN	Nimonic 75, Monel 400, Hastelloy C, Inconel 600	HR203, 3027-76		Nimonic 75, Monel 400, Hastelloy, Inconel 600	N06075, N10002, N04400, N06600	S 2
5.3		2.4668LN, 2.4631LN, 2.6554LN	Inconel 718, Nimonic 80A, Waspaloy	HR8, HR401, 601		Inconel 718, 625, Nimonic 80	N07718, N07080, N06625	S 3
6.1	EN 1652 – CW004A	2.0060, 2.0070	E-Cu57, SE-Cu	C101	5010	101	C10100, C1020	N 3
6.2	EN 1652 – CW612N	2.0380, 2.0360, 2.1030, 2.1080	CuZn39Pb2, CuZn40, CuSn8, CuSn6Zn	CZ120, CZ109, PB104	5168		C28000, C37710	N 4
6.3	EN 1652 – CW608L	2.0321, 2.0260	CuZn37, CuZn28	CZ108, CZ106	5150		C2600, C27200	N 3
6.4			Ampcoo 18, Ampco 25	AB1 type	5238, JM7-20			N 4
7.1	EN 485-2 – EN AW-1070A	3.0255	A189 5	LMO, 1 B (1050A)	4005	EC, 1060, 1100	A91060, A91100	N 1
7.2	EN 755-2 – EN AW-5005	3.1355, 3.3525	AlCuMg2, AlMg2Mn0.8	LM5, 10, 12, N4 (5251)	4106, 4212	380, 520.0, 520.2, 2024, 6061	A03800, A05200, A92024	N 1
7.3	EN 1706 – EN AC-42000	3.2162.05, 3.2341.01	GD-AlSi8Cu, G-AlSi5Mg	LM2, 4, 16, 18, 21, 22, 24, 25, 26, 27, L-109	4244	319.0, 333.0, 319.1, 356.0	A03190, A03330, C35600	N 1
8.1	SS-EN 1706 – EN AC-47000	3.2581.01	G-AS18, G-AS12	LM6, 12, 13, 20, 28, 29, 30	4260, 4261, 4262	4032, 222.1, A332.0	A94032, A02220, A13320	N 2
8.2			Polystyrene, Nylon, PVC Cellulose, Acetate & Nitrate			Polystyrene, Nylon, PVC		O
8.3			Ebonite, Tufnol, Bakelite			Bakelite		O
9.1			Kevlar, Pinned Circuit boards			Kevlar		O
10.1			Ferroc, Ferroitanit					H
			Graphite					O

Table of Cutting Speeds



		Vc															
m/Min		5	8	10	15	20	25	30	40	50	60	70	80	90	100	110	150
Feet/Min		16	26	32	50	66	82	98	130	165	197	230	262	296	330	362	495
Ø		RPM															
mm	inch																
1,00		1592	2546	3183	4775	6366	7958	9549	12732	15916	19099	22282	25465	28648	31831	35014	47747
1,50		1061	1698	2122	3183	4244	5305	6366	8488	10610	12732	14854	16977	19099	21221	23343	31831
2,00		796	1273	1592	2387	3183	3979	4775	6366	7958	9549	11141	12732	14324	15916	17507	23873
2,50		637	1019	1273	1910	2546	3183	3820	5093	6366	7639	8913	10186	11459	12732	14006	19099
3,00		531	849	1061	1592	2122	2653	3183	4244	5305	6366	7427	8488	9549	10610	11671	15916
3,18	1/8	500	801	1001	1501	2002	2502	3003	4004	5005	6006	7007	8008	9009	10010	11011	15015
3,50		455	728	909	1364	1819	2274	2728	3638	4547	5457	6366	7276	8185	9095	10004	13642
4,00		398	637	796	1194	1592	1989	2387	3183	3979	4775	5570	6366	7162	7958	8754	11937
4,50		354	566	707	1061	1415	1768	2122	2829	3537	4244	4951	5659	6366	7074	7781	10610
4,76	3/16	334	535	669	1003	1337	1672	2006	2675	3344	4012	4681	5350	6018	6687	7356	10031
5,00		318	509	637	955	1273	1592	1910	2546	3183	3820	4456	5093	5730	6366	7003	9549
6,00		265	424	531	796	1061	1326	1592	2122	2653	3183	3714	4244	4775	5305	5836	7958
6,35	1/4	251	401	501	752	1003	1253	1504	2005	2506	3008	3509	4010	4511	5013	5514	7519
7,00		227	364	455	682	909	1137	1364	1819	2274	2728	3183	3638	4093	4547	5002	6821
7,94	5/16	200	321	401	601	802	1002	1203	1604	2004	2405	2806	3207	3608	4009	4410	6013
8,00		199	318	398	597	796	995	1194	1592	1989	2387	2785	3183	3581	3979	4377	5968
9,00		177	283	354	531	707	884	1061	1415	1768	2122	2476	2829	3183	3537	3890	5305
9,53	3/8	167	267	334	501	668	835	1002	1336	1670	2004	2338	2672	3006	3340	3674	5010
10,00		159	255	318	477	637	796	955	1273	1592	1910	2228	2546	2865	3183	3501	4775
11,11	7/16	143	229	287	430	573	716	860	1146	1433	1719	2006	2292	2579	2865	3152	4298
12,00		133	212	265	398	531	663	796	1061	1326	1592	1857	2122	2387	2653	2918	3979
12,70	1/2	125	201	251	376	501	627	752	1003	1253	1504	1754	2005	2256	2506	2757	3760
14,00		114	182	227	341	455	568	682	909	1137	1364	1592	1819	2046	2274	2501	3410
14,29	9/16	111	178	223	334	446	557	668	891	1114	1337	1559	1782	2005	2228	2450	3341
15,00		106	170	212	318	424	531	637	849	1061	1273	1485	1698	1910	2122	2334	3183
15,88	5/8	100	160	200	301	401	501	601	802	1002	1203	1403	1604	1804	2004	2205	3007
16,00		99	159	199	298	398	497	597	796	995	1194	1393	1592	1790	1989	2188	2984
17,46	11/16	91	146	182	273	365	456	547	729	912	1094	1276	1458	1641	1823	2005	2735
18,00		88	141	177	265	354	442	531	707	884	1061	1238	1415	1592	1768	1945	2653
19,05	3/4	84	134	167	251	334	418	501	668	835	1003	1170	1337	1504	1671	1838	2506
20,00		80	127	159	239	318	398	477	637	796	955	1114	1273	1432	1592	1751	2387
24,00		66	106	133	199	265	332	398	531	663	796	928	1061	1194	1326	1459	1989
25,00		64	102	127	191	255	318	382	509	637	764	891	1019	1146	1273	1401	1910
27,00		59	94	118	177	236	295	354	472	589	707	825	943	1061	1179	1297	1768
30,00		53	85	106	159	212	265	318	424	531	637	743	849	955	1061	1167	1592
32,00		50	80	99	149	199	249	298	398	497	597	696	796	895	995	1094	1492
36,00		44	71	88	133	177	221	265	354	442	531	619	707	796	884	973	1326
40,00		40	64	80	119	159	199	239	318	398	477	557	637	716	796	875	1194
50,00		32	51	64	95	127	159	191	255	318	382	446	509	573	637	700	955



Hardness and Tensile Strength

HV Vickers	HRC Rockwell	HB Brinell	Newton's/ mm ²	Tons/ sq. in.
940	68			
900	67			
864	66			
829	65			
800	64			
773	63			
745	62			
720	61			
698	60			
675	59			
655	58		2200	142
650		618	2180	141
640		608	2145	139
639	57	607	2140	138
630		599	2105	136
620		589	2070	134
615	56	584	2050	133
610		580	2030	131
600		570	1995	129
596	55	567	1980	128
590		561	1955	126
580		551	1920	124
578	54	549	1910	124
570		542	1880	122
560	53	532	1845	119
550		523	1810	117
544	52	517	1790	116
540		513	1775	115
530		504	1740	113
527	51	501	1730	112
520		494	1700	110
514	50	488	1680	109
510		485	1665	108
500		475	1630	105
497	49	472	1620	105
490		466	1595	103
484	48	460	1570	102
480		456	1555	101
473	47	449	1530	99
470		447	1520	98
460		437	1485	96
458	46	435	1480	96
450		428	1455	94
446	45	424	1440	93
440		418	1420	92

HV Vickers	HRC Rockwell	HB Brinell	Newton's/ mm ²	Tons/ sq. in.
434	44	413	1400	91
423	43	402	1360	88
413	42	393	1330	86
403	41	383	1300	84
392	40	372	1260	82
382	39	363	1230	80
373	38	354	1200	78
364	37	346	1170	76
355	36	337	1140	74
350		333	1125	73
345	35	328	1110	72
340		323	1095	71
336	34	319	1080	70
330		314	1060	69
327	33	311	1050	68
320		304	1030	67
317	32	301	1020	66
310	31	295	995	64
302	30	287	970	63
300		285	965	62
295		280	950	61
293	29	278	940	61
290		276	930	60
287	28	273	920	60
285		271	915	59
280	27	266	900	58
275		261	880	57
272	26	258	870	56
270		257	865	56
268	25	255	860	56
265		252	850	55
260	24	247	835	54
255	23	242	820	53
250	22	238	800	52
245		233	785	51
243	21	231	780	50
240		228	770	50
235		223	755	49
230		219	740	48
225		214	720	47
220		209	705	46
215		204	690	45
210		199	675	44
205		195	660	43
200		190	640	41

Tolerances



Tol	Ø mm							
	> 1 ≤ 3	> 3 ≤ 6	> 6 ≤ 10	> 10 ≤ 18	> 18 ≤ 30	> 30 ≤ 50	> 50 ≤ 80	> 80 ≤ 120
	µm							
e8	-14 / -28	-20 / -38	-25 / -47	-32 / -59	-40 / -73	-50 / -89	-60 / -106	-72 / -126
f6	-6 / -12	-10 / -18	-13 / -22	-16 / -27	-20 / -33	-25 / -41	-30 / -49	-36 / -58
f7	-6 / -16	-10 / -22	-13 / -28	-16 / -34	-20 / -41	-25 / -50	-30 / -60	-36 / -71
h6	0 / -6	0 / -8	0 / -9	0 / -11	0 / -13	0 / -16	0 / -19	0 / -22
h7	0 / -10	0 / -12	0 / -15	0 / -18	0 / -21	0 / -25	0 / -30	0 / -35
h8	0 / -14	0 / -18	0 / -22	0 / -27	0 / -33	0 / -39	0 / -46	0 / -54
h9	0 / -25	0 / -30	0 / -36	0 / -43	0 / -52	0 / -62	0 / -74	0 / -87
h10	0 / -40	0 / -48	0 / -58	0 / -70	0 / -84	0 / -100	0 / -120	0 / -140
h11	0 / -60	0 / -75	0 / -90	0 / -110	0 / -130	0 / -160	0 / -190	0 / -220
h12	0 / -100	0 / -120	0 / -150	0 / -180	0 / -210	0 / -250	0 / -300	0 / -350
k10	+40 / 0	+48 / 0	+58 / 0	+70 / 0	+84 / 0	+100 / 0	+120 / 0	+140 / 0
k12	+100 / 0	+120 / 0	+150 / 0	+180 / 0	+210 / 0	+250 / 0	+300 / 0	+350 / 0
m7	+2 / +12	+4 / +16	+6 / +21	+7 / +25	+8 / +29	+9 / +34	+11 / +41	+13 / +48
js14	+/- 125	+/- 150	+/- 180	+/- 215	+/- 260	+/- 310	+/- 370	+/- 435
js16	+/- 300	+/- 375	+/- 450	+/- 550	+/- 650	+/- 800	+/- 950	+/- 1100
H7	+10 / 0	+12 / 0	+15 / 0	+18 / 0	+21 / 0	+25 / 0	+30 / 0	+35 / 0
H8	+14 / 0	+18 / 0	+22 / 0	+27 / 0	+33 / 0	+39 / 0	+46 / 0	+54 / 0
H9	+25 / 0	+30 / 0	+36 / 0	+43 / 0	+52 / 0	+62 / 0	+74 / 0	+87 / 0
H12	+100 / 0	+120 / 0	+150 / 0	+180 / 0	+210 / 0	+250 / 0	+300 / 0	+350 / 0
P9	-6 / -31	-12 / -42	-15 / -51	-18 / -61	-22 / -74	-26 / -86	-32 / -106	-37 / -124

1µm = 0.001mm

DRILLING

GENERAL HINTS ON DRILLING

1. Select the most appropriate drill for the application, bearing in mind the material to be machined, the capability of the machine tool and the coolant to be used.
2. Flexibility within the component and machine tool spindle can cause damage to the drill as well as the component and machine - ensure maximum stability at all times. This can be improved by selecting the shortest possible drill for the application.
3. Tool holding is an important aspect of the drilling operation and the drill cannot be allowed to slip or move in the tool holder.
4. The correct use of Morse Taper Shank drills relies on an efficient fit between the taper surfaces of the tool and the tool holder. The use of a soft-faced hammer should be used to drive the drill into the holder.
5. The use of suitable coolants and lubricants are recommended as required by the particular drilling operation. When using coolants and lubricants, ensure a copious supply, especially at the drill point.
6. Swarf evacuation whilst drilling is essential in ensuring the correct drilling procedure. Never allow the swarf to become stationary in the flute.
7. When regrinding a drill, always make sure that the correct point geometry is produced and that any wear has been removed.

HOLE SIZE

As geometric, substrate and coating configurations become more advanced, the ability of a drill to produce a more accurate hole size increases. In general, a standard geometry tool will achieve a hole size to H12. However as the configuration of the drill becomes more complex the achievable hole size, under favourable conditions, can be as good as H8. To offer a better insight, listed below are the product types and their achievable hole tolerances:

- HSS General Purpose drills – H12
- HSS / HSS-E Parabolic Flute Deep Hole Drills – H10
- Solid Carbide High Performance coated – H8/H9

DEEP HOLE DRILLING STRATEGY

When drilling deep holes, several methods can be adopted to achieve the depth required. The example below shows four ways of drilling a hole with 10 x the diameter of the drill.

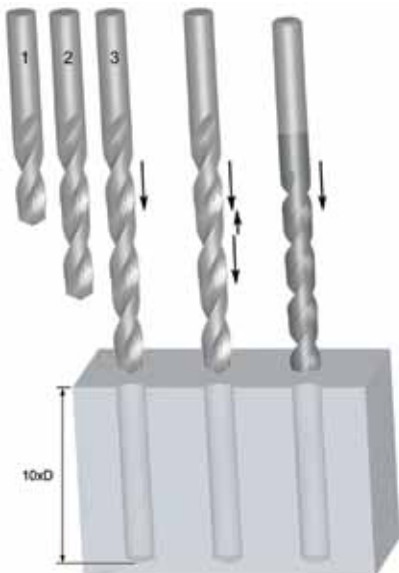

	Series Drilling	Series Drilling
No of drills	3 (2,5xD, 6xD, 10xD)	2 (2,5xD, 10xD)
Type of drill	Standard geometry, general purpose	Standard geometry, general purpose
+ / -	Expensive Time consuming	More cost effective Quick

	Peck Drilling	Single Pass Drilling
No of drills	1 (10xD)	1 (10xD)
Type of drill	Standard geometry, general purpose	Purpose specific tools
+ / -	Time consuming	Cost effective Fast

TROUBLE SHOOTING WHEN DRILLING

PROBLEM	CAUSE	REMEDY
Broken or twisted tangs	Bad fit between shank and socket	Ensure the shank and socket are clean and free from damage
Splitting of the web	Feed too high	Reduce feed to optimum rate
	Insufficient initial clearance	Regrind to correct specification
	Excessive web thinning	Regrind to correct specification
	Heavy impact at point of drill	Avoid impact at the point of drill. Take care with taper shank drills when inserting/ejecting from spindle
Worn outer corner	Excessive speed	Reduce speed to optimum - may be able to increase feed
Broken outer corners	Unstable component set up	Reduce movement in the component
Chipped cutting lips	Excessive initial clearance	Regrind to correct specification
Breakage at flute run out	Choking of flutes	Adopt a peck/series drilling concept
	Drill slipping	Ensure the drill is held securely in the chuck and spindle
Spiral finish in hole	Insufficient feed	Increase feed
	Bad positional accuracy	Use a spot drill before drilling
Hole size too large	Incorrect point geometry	Check point geometry
	Ineffective swarf clearance	Adjust speed, feed and peck length to achieve more manageable swarf

REAMING

GENERAL HINTS ON REAMING

To obtain the best results when using reamers it is essential to make them 'work'. It is a common fault to prepare holes for reaming with too little stock left in. If insufficient stock is left in the hole before reaming, then the reamer will rub, quickly show wear and will result in loss of diameter. It is equally important for performance not to leave too much stock in the hole. (See Stock Removal below).

1. Select the optimum type of reamer and the optimum speeds and feeds for the application. Ensure that pre-drilled holes are the correct diameter.
2. The workpiece must be held rigid and the machine spindle should have no play.
3. The chuck in which a straight shank reamer is held must be good quality. If the reamer slips in the chuck and the feed is automatic, breakage of the reamer may occur.
4. Keep tool overhang from machine spindle to a minimum.
5. Use recommended lubricants to enhance the life of the reamer and ensure the fluid reaches the cutting edges. As reaming is not a heavy cutting operation, soluble oil 40:1 dilution is normally satisfactory. Air blasting may be used with grey cast iron, if dry machining.
6. Do not allow the flutes of a reamer to become blocked with swarf.
7. Before the reamer is reground, check concentricity between centres. In most instances only the bevel lead will need regrinding.
8. Keep reamers sharp. Frequent regrinding is good economy, but it is important to understand that reamers cut only on the bevel and taper leads and not on the lands. Consequently only these leads need regrinding. Accuracy of regrinding is important to hole quality and tool life.

STOCK REMOVAL

The recommended stock removal in reaming is dependent on the application material and the surface finish of the pre-drilled hole. General guidelines for stock removal are shown in the following tables:

Size of reamed hole (mm)	When pre-drilled	When pre-core-drilled
Below 4	0.1	0.1
Over 4 to 11	0.2	0.15
Over 11 to 39	0.3	0.2
Over 39 to 50	0.4	0.3

Size of reamed hole (inches)	When pre-drilled	When pre-core-drilled
Below 3/16	0.004	0.004
3/16 to 1/2	0.008	0.006
1/2 to 1.1/2	0.010	0.008
1.1/2 to 2	0.016	0.010

TOLERANCE LIMITS



1. ON THE CUTTING DIAMETER OF STANDARD REAMERS

The diameter (d_1) is measured across the circular land immediately behind the bevel or taper lead. The tolerance is in accordance with DIN 1420 and is intended to produce H7 holes.

REAMER TOLERANCE			
Diameter (mm)		Tolerance Limit (mm)	
Over	Up to and including	High +	Low +
	3	0.008	0.004
3	6	0.010	0.005
6	10	0.012	0.006
10	18	0.015	0.008

REAMER TOLERANCE			
Diameter (mm)		Tolerance Limit (mm)	
Over	Up to and including	High +	Low +
18	30	0.017	0.009
30	50	0.021	0.012
50	80	0.025	0.014

2. ON A H7 HOLE

The most common tolerance on a finished hole is H7 (see table below). For any other tolerance the figure and table beneath point 3 can be used to calculate the reamers tolerance location and width.

HOLE TOLERANCE			
Diameter (mm)		Tolerance Limit (mm)	
Over	Up to and including	High +	Low +
	3	0.010	0
3	6	0.012	0
6	10	0.015	0
10	18	0.018	0

HOLE TOLERANCE			
Diameter (mm)		Tolerance Limit (mm)	
Over	Up to and including	High +	Low +
18	30	0.021	0
30	50	0.025	0
50	80	0.030	0

3. When it is necessary to define the dimensions of a special reamer intended to cut to a specific tolerance, e.g. D8, this well proven guide can be used.

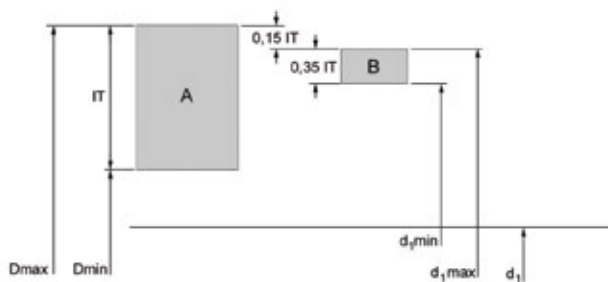

A = Hole Tolerance
 B = Reamer Tolerance
 IT = Tolerance Width
 Dmax = Max Diameter of Hole
 Dmin = Min Diameter of Hole
 d_1 = Nominal Diameter
 $d_{1,max}$ = Max Diameter of Reamer
 $d_{1,min}$ = Min Diameter of Reamer

Tolerance width (microns)	Diameter Tolerance Width (mm)								
	over 1 incl. 3	over 3 incl. 6	over 6 incl. 10	over 10 incl. 18	over 18 incl. 30	over 30 incl. 50	over 50 incl. 80	over 80 incl. 120	
IT5	4	5	6	8	9	11	13	15	
IT6	6	8	9	11	13	16	19	22	
IT7	10	12	15	18	21	25	30	35	
IT8	14	18	22	27	33	39	46	54	
IT9	25	30	36	43	52	62	74	87	
IT10	40	48	58	70	84	100	120	140	
IT11	60	75	90	110	130	160	190	220	
IT12	100	120	150	180	210	250	300	350	

e.g. 10mm hole with tolerance D8, Max dia = 10.062, Min dia = 10.040, Hole tol (IT8) = 0.022

Maximum limit: $0.15 \times \text{hole tolerance (IT8)} = 0.0033$, rounded up = 0.004
 Minimum limit: $0.35 \times \text{hole tolerance (IT8)} = 0.0077$, rounded up = 0.008

Maximum limit for reamer = $10.062 - 0.004 = 10.058$
 Minimum limit for reamer = $10.058 - 0.008 = 10.050$

TROUBLE SHOOTING WHEN REAMING

PROBLEM	CAUSE	REMEDY
Broken or twisted tangs	Incorrect fit between shank and socket	Ensure the shank and socket are clean and free from damage
Rapid tool wear	Insufficient stock to remove	Increase the amount of stock to be removed
Oversize hole	Excessive lip height variation	Regrind to correct specification
	Displacement in the machine spindle	Repair and rectify spindle displacement
	Deflects on the tool holder	Replace tool holder
	Tool shank is damaged	Replace or regrind the shank
	Ovality of the tool	Replace or regrind the tool
	Asymmetric bevel lead angle	Regrind to correct specification
	Too high feed or cutting speed	Adjust cutting conditions in accordance with Catalogue
Undersize hole	Insufficient stock to remove	Increase the amount of stock to be removed
	Too much heat generated while reaming. The hole widens and shrinks	Increase coolant flow
	The tool diameter is worn and is undersize	Regrind to correct specification
	Too low feed or cutting speed	Adjust cutting conditions in accordance with the Catalogue
	Pre-drilled hole is too small	Decrease the amount of stock to be removed
Oval and conical holes	Displacement in the machine spindle	Repair and rectify spindle displacement
	Misalignment between tool and hole	Use a bridge reamer
	Asymmetric bevel lead angle	Regrind to correct specification
Bad hole finish	Excessive stock to remove	Decrease the amount of stock to be removed
	Worn out tool	Regrind to correct specification
	Too small cutting rake angle	Regrind to correct specification
	Too diluted emulsion or cutting oil	Increase % concentration
	Feed and/or speed too low	Adjust cutting conditions in accordance with Catalogue
	Cutting speed too high	Adjust cutting conditions in accordance with Catalogue
The tool clamps and breaks	Worn out tool	Regrind to correct specification
	Back taper of the tool is too small	Check and replace/modify the tool
	The width of the land is too wide	Check and replace/modify the tool
	Workpiece material tend to squeeze	Use an adjustable reamer to compensate for the displacement
	Pre-drilled hole is too small	Decrease the amount of stock to be removed
	Heterogeneous material with hard inclusions	Use solid carbide reamer

THREADING

GENERAL HINTS ON TAPPING

The success of any tapping operation depends on a number of factors, all of which affect the quality of the finished product.

1. Select the correct design of tap for the component material and type of hole, i.e. through or blind, from the Materials Classification chart.
2. Ensure the component is securely clamped - lateral movement may cause tap breakage or poor quality threads.
3. Select the correct size of drill from the relevant catalogue page. Always ensure that work hardening of the component material is kept to a minimum.
4. Select the correct cutting speed as shown on the catalogue product page.
5. Use appropriate cutting fluid for correct application.
6. In NC applications ensure that the feed value chosen for the program is correct. When using a tapping attachment, 95% to 97% of the pitch is recommended to allow the tap to generate its own pitch.
7. Where possible, hold the tap in a good quality torque limiting tapping attachment, which ensures free axial movement of the tap and presents it squarely to the hole. It also protects the tap from breakage if accidentally 'bottomed' in a blind hole.
8. Ensure smooth entry of the tap into the hole, as an uneven feed may cause 'bell mouching'.

TAP TOLERANCE VS TOLERANCE ON INTERNAL THREAD (NUT)

Tolerance class, Tap			Tolerance, Internal thread (Nut)					Application
ISO	DIN	ANSI BS						
ISO 1	4 H	3 B	4 H	5 H				Fit without allowance
ISO 2	6 H	2 B	4 G	5 G	6 H			Normal fit
ISO 3	6 G	1 B			6 G	7 H	8 H	Fit with large allowance
-	7 G	-				7 G	8 G	Loose fit for following treatment or coating

TROUBLE SHOOTING WHEN TAPPING

PROBLEM	CAUSE	REMEDY
Oversize	Incorrect tolerance	Choose a tap with lower thread tolerance
	Incorrect axial feed rate	Reduce feed rate by 5-10% or increase compression of tap holder
	Wrong type of tap for application	Use spiral point for through hole or spiral flute for blind hole. Use coated tool to prevent built up edge. Check Catalogue or Product Selector for correct tool alternative
	Tap not centered on the hole	Check tap holder and position tap centre on the hole
	Lack of lubrication	Use good lubrication in order to prevent built up edge. See lubricant section in technical handbook
	Tap speed too slow	Follow recommendation in Catalogue / Product Selector
Undersize	Wrong type of tap for application	Use spiral point for through hole or spiral flute for blind hole. Use coated tool to prevent built up edge. Use tap with higher rake angle. Check Catalogue or Product Selector for correct tool alternative
	Incorrect tolerance	Choose a tap with higher tolerance, especially on material with low oversize tendency, such as cast iron, stainless steel
	Incorrect or lack of lubricant	Use good lubrication in order to prevent chip blockage inside the hole. See lubricant section in technical handbook
	Tap drill hole too small	Increase drill diameter to the maximum value. Check tapping size drill
	Material closing in after tapping	See recommendation in Catalogue / Product Selector for correct tool alternative
Chipping	Wrong type of tap for application	Choose a tap with lower rake angle. Choose a tap with longer chamfer. Use spiral point taps for through hole and spiral flute for blind holes, in order to avoid chip blockage. Check Catalogue or Product Selector for correct tool alternative
	Incorrect or lack of lubricant	Use good lubrication in order to prevent built up edge. See lubricant section in technical handbook
	Taps hit bottom of hole	Increase depth of drilling or decrease depth of tapping
	Work hardening surface	Reduce speed, use coated tool, use good lubrication. See section for machining of stainless steel in technical handbook
	Swarf trapping on reversal	Avoid sudden return of tap on reversal motion
	Chamfer hits hole entrance	Check axial position and reduce axial error of tap point on hole centre
	Tap drill hole too small	Increase drill diameter to maximum value. Check tapping size drill

TROUBLE SHOOTING WHEN TAPPING

PROBLEM	CAUSE	REMEDY
Breakage	Tap worn out	Use a new tap or regrind the old one
	Lack of lubricant	Use good lubrication in order to prevent built up edge and chip blockage. See lubricant section in technical handbook
	Taps hit bottom of hole	Increase depth of drilling or decrease depth of tapping
	Tap speed too high	Reduce cutting speed. Follow recommendation in Catalogue / Product Selector
	Work hardening surface	Reduce speed. Use coated tool Use good lubrication. See section for machining of stainless steel in technical handbook
	Tap drill hole too small	Increase drill diameter up to maximum value. See tap drill tables
	Too high torque	Use tapping attachment with torque adjustment clutch
	Material closing in after tapping	See recommendation in Catalogue / Product Selector for correct tool alternative
Rapid wear	Wrong type of tap for application	Use tap with lower rake angle and/or higher relief and/or longer chamfer. Use coated tool. Check Catalogue or Product Selector for correct tool alternative
	Lack of lubricant	Use good lubrication in order to prevent built up edge and thermal stress on cutting edge. See lubricant section in technical handbook
	Tap speed too high	Reduce cutting speed. Follow recommendation in Catalogue / Product Selector
Built up edge	Wrong type of tap for application	Use tap with lower rake angle and/or higher relief. Check Catalogue or Product Selector for correct tool alternative
	Lack of lubricant	Use good lubrication in order to prevent built up edge. See lubricant section in technical handbook
	Surface treatment not suitable	Choose a tap with the recommended surface treatment
	Tap speed too low	Follow recommendation in Catalogue / Product Selector

MILLING

GENERAL HINTS ON MILLING

Milling is a process of generating machined surfaces by progressively removing a predetermined amount of material or stock from the workpiece at a relatively slow rate of movement or feed by a milling cutter rotating at a comparatively high speed.

The characteristic feature of the milling process is that each milling cutter tooth removes its share of the stock in the form of small individual chips

TYPE OF MILLING CUTTERS

The three basic milling operations are shown below: (A) peripheral milling, (B) face milling and (C) end milling.

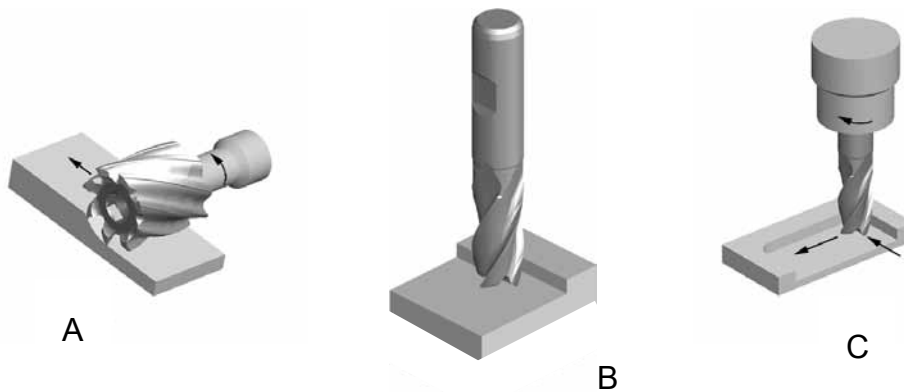

In peripheral milling (also called slab milling), the axis of cutter rotation is parallel to the workpiece surface to be machined. The cutter has a number of teeth along its circumference, each tooth acting like a single-point cutting tool called a plain mill. Cutters used in peripheral milling may have straight or helical teeth generating an orthogonal or oblique cutting action.

In face milling, the cutter is mounted on a spindle with an axis of rotation perpendicular to the workpiece surface. The milled surface results from the action of cutting edges located on the periphery and face of the cutter.

In end milling, the cutter generally rotates on an axis vertical to the workpiece. It can be tilted to machine tapered surfaces. Cutting teeth are located on both the end face of the cutter and the periphery of the cutter body.

DIFFERENT APPLICATIONS FOR END MILLS

The MRR and the applications are strongly related. For each different application we have a different MRR that increases with the engagement section of the cutter on the workpiece. The recent Dormer Catalogue was produced with simple icons that show the different applications.

Side Milling	Face Milling	Slot Milling	Plunge Milling	Ramping
The radial depth of cut should be less than 0.25 of the diameter of the end mill.	The radial depth of cut should be no more than 0.9 of the diameter, axial depth of cut less than 0.1 of the diameter.	Machining of a slot for keyways. The radial depth of cut is equal to the diameter on the end mill.	It is possible to drill the workpiece with an end mill only with the cutting centre. In this operation the feed has to be halved.	Both axial and radial entering into the workpiece.

GENERAL HINTS



TROUBLE SHOOTING WHEN MILLING

PROBLEM	CAUSE	REMEDY
Breakage	Too high stock removal	Decrease feed per tooth
	Feed too fast	Slow down feed
Wear	Flute length or overall length too long	Hold shank deeper, use shorter end mill
	Workpiece material too hard	Check Catalogue or Selector for correct tool with higher grade material and/or proper coating
	Improper feed and speed	Check Catalogue or Selector for correct cutting parameters
	Poor chip evacuation	Reposition coolant lines
	Conventional milling	Climb milling
	Improper cutter helix	See recommendation in Catalogue/Selector for correct tool alternative
Chipping	Feed rate too high	Reduce feed rate
	Chattering	Reduce the RPM
	Low cutting speed	Increase the RPM
	Conventional milling	Climb milling
	Tool rigidity	Choose a shorter tool and/or place shank further up holder
	Workpiece rigidity	Hold workpiece tightly
Short Tool Life	Tough work material	Check Catalogue or Selector for correct tool alternative
	Improper cutting angle and primary relief	Change to correct cutting angle
	Cutter/workpiece friction	Use coated tool
Bad Surface finish	Feed too fast	Slow down to correct speed
	Speed too slow	Increase the speed
	Chip biting	Decrease stock removal
	Tool wear	Replace or regrind the tool
	Edge build up	Change to higher helix tool
	Chip welding	Increase coolant quantity

GENERAL HINTS

PROBLEM	CAUSE	REMEDY
Workpiece inaccuracy	Tool deflection	Choose a shorter tool and/or place shank further up holder
	Insufficient number of flutes	Use a tool with more flutes
	Loose/worn tool holder	Repair or replace it
	Poor tool holder rigidity	Replace with shorter/more rigid tool holder
	Poor spindle rigidity	Use larger spindle
Chattering	Feed and speed too high	Correct feed and speed with the help of the Catalogue/Selector
	Flute or overall length too long	Hold shank deeper and use shorter end mill
	Cutting too deep	Decrease depth of cut
	Not enough rigidity (machine and holder)	Check the tool holder and change it if necessary



<http://selector.dormertools.com>

AMG	中文	Português	Español	English
1.1	铁磁性低碳钢	Aço macio magnético	Acero blando	Magnetic soft steel
1.2	结构钢, 表面渗碳钢	Aço estrutural, Aço cementado	Acero de construcción/cementación	Structural steel, case carburizing steel
1.3	普通碳钢	Aço-carbono	Acero al carbono	Plain Carbon steel
1.4	合金钢	Aço de liga	Acero aleado	Alloy steel
1.5	合金钢, 淬火回火钢	Aço de liga, Aço temperado	Acero aleado/temple y revenido	Alloy steel, Hardened and tempered steel
1.6	合金钢, 淬火回火钢	Aço de liga, Aço temperado	Acero aleado/temple y revenido	Alloy steel, Hardened and tempered steel
1.7	热处理合金钢	Aço de liga temperado	Acero aleado cementado	Alloy steel, Heat treated
1.8	淬火合金钢, 耐磨钢	Aço de liga temperado	Acero aleado cementado	Alloy steel, Hardened & Wear resistant steel
2.1	易切削不锈钢	Aço inoxidável de maquinagem fácil	Acero inoxidable fácil mecanizado	Free machining, Stainless Steel
2.2	奥氏体不锈钢	Austenítico	Austenítico	Austenitic
2.3	铁素体 + 奥氏体, 马氏体不锈钢	Ferrítico + Austenítico + Martensítico	Ferrítico, Ferr. + Aust., Marten	Ferritic + Austenitic, Ferritic, Martensitic
2.4	沉淀硬化不锈钢	Aço inoxidável de fácil usinagem	Acero Inoxidable Templado	Precipitation Hardened
3.1	灰铸铁	Grafite laminar	Con grafito laminar	Lamellar graphite
3.2	灰铸铁	Grafite laminar	Con grafito laminar	Lamellar graphite
3.3	球墨铸铁, 可锻铸铁	Grafite nodular/ Ferro fundido maleável	Con graf. laminar, fundic. maleable	Nodular graphite, Malleable Cast Iron
3.4	球墨铸铁, 可锻铸铁	Grafite nodular/ Ferro fundido maleável	Con graf. laminar, fundic. maleable	Nodular graphite, Malleable Cast Iron
4.1	纯钛	Titânio, sem liga	Titânio no aleado	Titanium, unalloyed
4.2	钛合金	Titânio, com liga	Titânio aleado	Titanium, alloyed
4.3	钛合金	Titânio, com liga	Titânio aleado	Titanium, alloyed
5.1	纯镍	Níquel, sem liga	Níquel no aleado	Nickel, unalloyed
5.2	镍合金	Níquel, com liga	Níquel aleado	Nickel, alloyed
5.3	镍合金	Níquel, com liga	Níquel aleado	Nickel, alloyed
6.1	紫铜	Cobre	Cobre	Copper
6.2	β黄铜, 青铜	Latão beta, bronze	β-Latón, bronce	β-Brass, Bronze
6.3	α黄铜	Latão alfa	α-Latón	α-Brass
6.4	高强度青铜	Bronze de alta resistência	Metal AMPCO	High Strength Bronze
7.1	纯铝, 纯镁	Al, Mg, sem liga	Al, Mg, no aleado	Al, Mg, unalloyed
7.2	铝合金, 硅含量 < 0.5%	Al com liga, Si<0.5%	Al aleado con Si < 0.5%	Al alloyed, Si < 0.5%
7.3	铝合金, 硅含量 > 0.5% < 10%	Al com liga, Si>0.5%<10%	Al aleado con Si > 0.5% < 10%	Al alloyed, Si > 0.5% < 10%
7.4	铝合金, 硅含量 > 10% 晶须增强铝合金, 镁合金	Al com liga, Si>10% reforçadas com monocristais filiformes, ligas de Al/Mg	Al aleado, Si>10% Reforzado por filamentos, Al-aleados, Mg-aleados	Al alloyed, Si > 10% Whisker reinforced Al-alloys Mg-alloys
8.1	热塑性塑料	Termoplásticos	Termoplásticos	Thermoplastics
8.2	热固性塑料	Plásticos termoduros	Plásticos endurecidos por calor	Thermosetting plastics
8.3	增强塑料	Materiais plásticos reforçados	Materiales plásticos reforzados	Reinforced plastic materials
9.1	金属陶瓷	Cerametal (metalocerâmica)	Cerametales (metales-cerámicas)	Cermets (metals-ceramics)
10.1	标准石墨	Grafite standard	Grafito standard	Graphite

SIMPLY RELIABLE

As a professional you can judge the quality of work by just looking at the chip. Our chip is a clean and uncomplicated shape that in itself tells a story. It is a clear and consistent signal and that's why we use it as a symbol for being simply reliable.

Dormer Tools International

responsible for **Middle East, Far East**

T: +44 1246 571338
F: +44 1246 571339
dormer.int@dormertools.com

United Kingdom

responsible for **Ireland**

T: 0870 850 4466
F: 0870 850 8866
dormer.uk@dormertools.com

France

T: +33 (0)2 47 62 57 01
F: +33 (0)2 47 62 52 00
dormer.fr@dormertools.com

Italy

T: +39 02 38 04 51
F: +39 02 38 04 52 43
dormer.it@dormertools.com

Spain

T: +34 935717722
F: +34 935717765
info.safety-iberica@safety-cuttingtools.com
responsible for

Portugal

T: +351 21 424 54 21
F: +351 21 424 54 25

Germany

T: +49 9131 933 08 70
F: +49 9131 933 08 742
dormer.de@dormertools.com
responsible for

Switzerland

T: +49 9131 933 08 70
F: +49 9131 933 08 742
dormer.ch@dormertools.com

Netherlands

T: +31 10 2080 240
F: +31 10 2080 282
dormer.nl@dormertools.com
responsible for

Austria

T: +31 10 2080 212
F: +31 10 2080 282
dormer.at@dormertools.com
and

Belgium

T: +32 3 440 59 01
F: +32 3 449 15 43
Email: dormer.be@dormertools.com

Sweden

responsible for
Iceland, Lithuania, Latvia, Estonia
T: +46 (0) 35 16 52 00
F: +46 (0) 35 16 52 90
dormer.se@dormertools.com
Kundservice
T: direkt +46 35 16 52 96
F: direkt +46 35 16 52 90

Finland

T: +358 205 44 121
F: +358 205 44 5199
Customer Service
T: direkt 0205 44 7003
F: direkt 0205 44 7004
dormer.fi@dormertools.com

Norway

T: +47 67 17 56 00
F: +47 66 85 96 10
dormer.no@dormertools.com
Kundeservice
T: direkt 800 10 113
F: direkt +46 35 16 52 90

Denmark

T: +45 43 46 52 80
F: +45 43 46 52 81
dormer.dk@dormertools.com
Kundtjeneste
T: direkt 808 82106
F: direkt +46 35 16 52 90

Czech Republic

T: +420 583 381 111
F: +420 583 215 401
pramet.info.cz@pramet.com
responsible for **Export CEE, Romania, Macedonia, Slovenia, Serbia, Ukraine, Bosnia-Herzegovina, Croatia, Belarus, Montenegro, Bulgaria**
pramet.info.row@pramet.com

Slovakia

T: +421 417 645 659
F: +421 417 637 449
pramet.info.sk@pramet.com

Russia

T: +7 495 775 10 28
pramet.info.ru@pramet.com

Hungary

T: +36-96 / 522-846
F: +36-96 / 522-847
pramet.info.hu@pramet.com

Poland

T: +48 32 78-15-890
F: +48 32 78-60-406
pramet.info.pl@pramet.com

United States of America

responsible for **Mexico**
T: (847) 783-5700
F: (847) 783-5760
cs@precisiondormer.com

Canada

T: (888) 336 7637
En Français: (888) 368 8457
F: (905) 542 7000
cs@precisiondormer.com

Brazil

responsible for **Bolivia, Panama, Chile, Paraguay, Colombia, Peru, Costa Rica, Uruguay, Ecuador, Venezuela, Guatemala**
T: +55 11 5660 3000
F: +55 11 5667 5883
dormer.br@dormertools.com

Argentina

T: 54 (11) 6777-6777
F: 54 (11) 4441-4467
dormer.ar@dormertools.com

Australia

T: 1300 131 274
F: +61 3 9238 7105
dormer.int@dormertools.com

New Zealand

T: +64 9 2735858
F: +64 9 2735857
dormer.int@dormertools.com

China

T: +86 21 24160508
F: +86 21 5442 6315
dormer.cn@dormertools.com

India

T: +91 124 470 3825
dormer.in@dormertools.com

DORMER PRAMET



DORCAT2015CBSE

dormertools.com